

NO
NO
NO
NO



CONTENTS

2 Comparison Chart

4 Can-Am Ryker™

6 Ryker Accessories

18 Can-Am Spyder® F3™

20 Spyder F3 Accessories

38 Can-Am Spyder RT™

40 Spyder RT Accessories

54 Can-Am Freedom Trailer

56 Riding Gear

57 Men's

63 Women's

67 Bags

68 Helmets

71 Communication Systems

72 Sizing Chart

73 Warranties

74 Lifestyle and Gifts

76 Genuine Can-Am Parts

78 XPS Oil and Maintenance

EXPERIENCE CAN-AM ON-ROAD

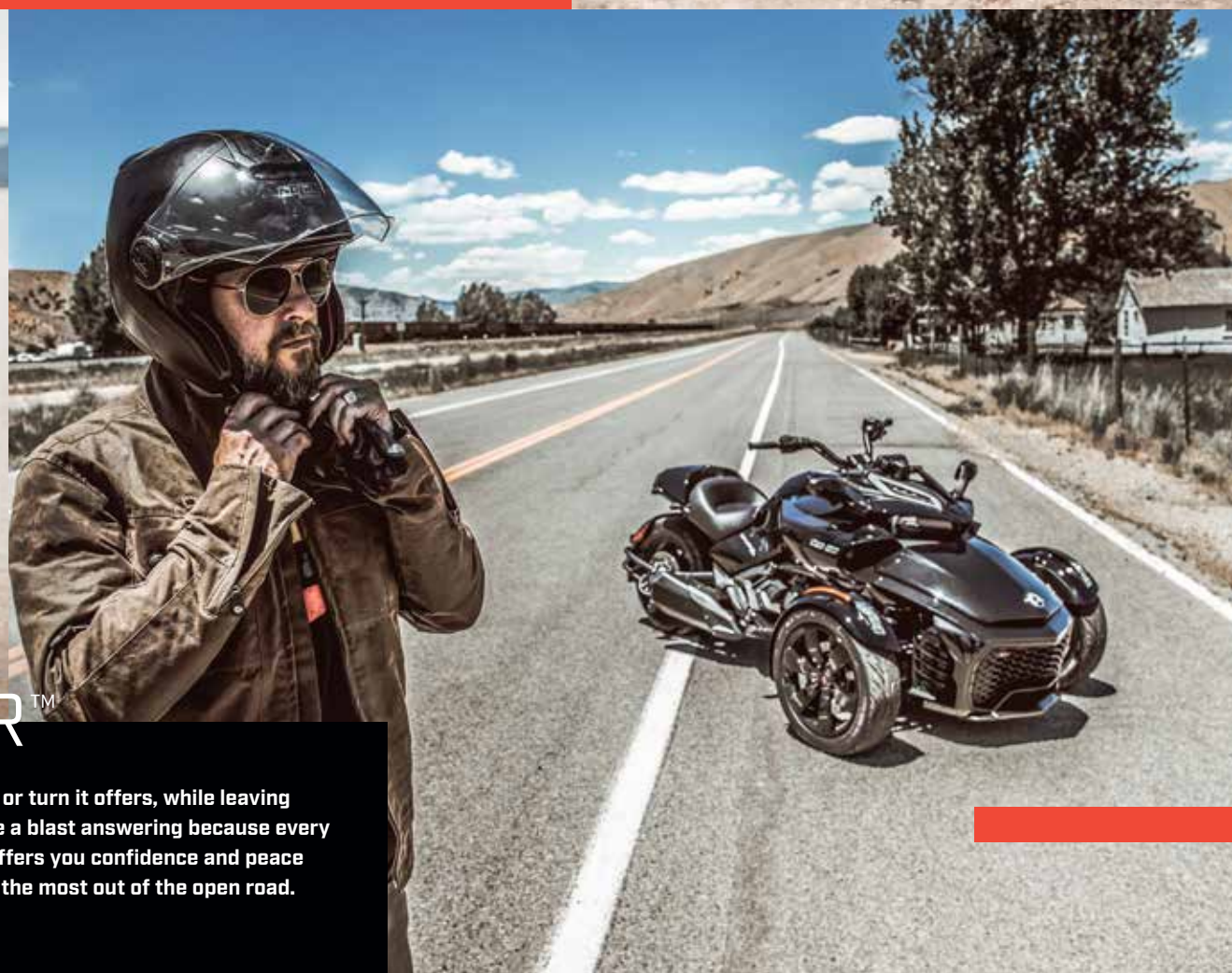
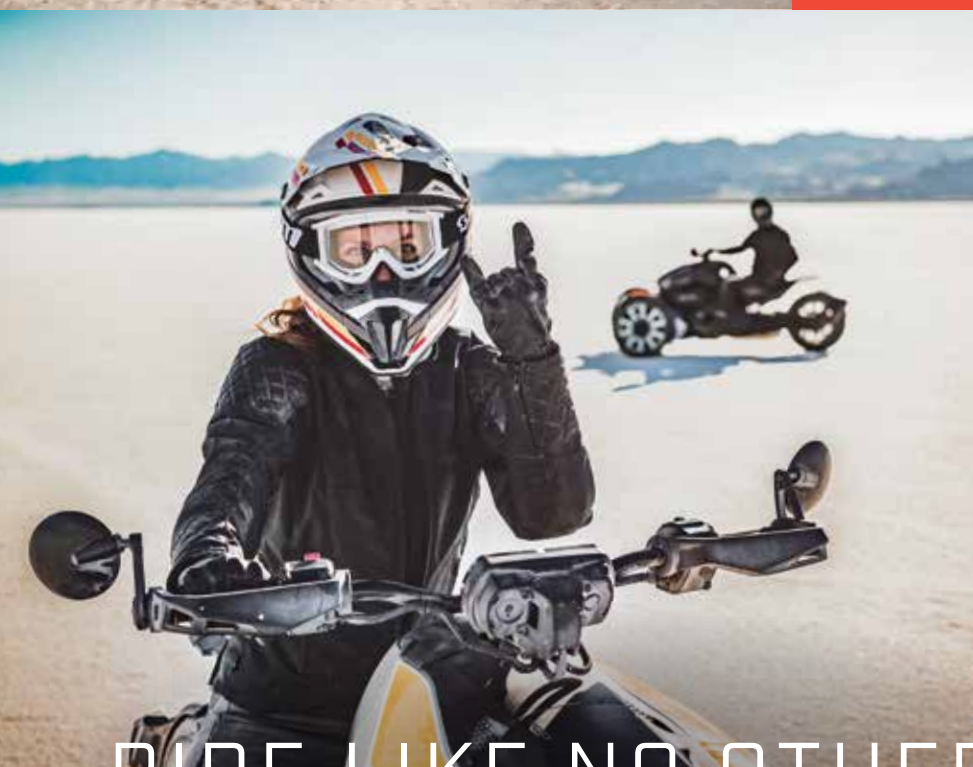

RIDE LIKE NO OTHER™

With 3 wheels driving you forward, you'll see more of the open road, take any twist or turn it offers, while leaving no stone, pebble or chunk of loose dirt unturned. The road is calling. And you'll have a blast answering because every Can-Am On-Road vehicle is designed for ultimate stability with performance that offers you confidence and peace of mind. With a quick learning curve to riding, all you have to think about is making the most out of the open road.

© 2019 Bombardier Recreational Products Inc. (BRP). All rights reserved. ®, ™ and the BRP logo are trademarks of BRP or its affiliates. 3M and SCOTCHLITE are trademarks of 3M Company. BLUE-TOOTH is a registered trademark of Bluetooth SIG. CLARINO is a trademark of Kuraray Co. Ltd. FOX and PODIUM are trademarks of FOX Racing Canada. HIPORA is a registered trademark of Kolon Industries. IPOD and IPAD are registered trademarks of Apple Inc. TEFLON is a registered trademark of E.I. DuPont de Nemours & Co. LEXAN is a registered trademark of SABIC Innovative Plastics Holding BV. PINLOCK is a registered trademark of Pinlock Group BV. NCOM SYSTEM and NOLAN are registered trademarks of Nolan Helmets SpA. NGK is a registered trademark of NGK Spark Plugs Ltd. RAM is a registered trademark of RAM Mounting Systems Inc. SENA is a trademark of Sena Technologies, Inc. SILICONE is a registered trademark of Dow Corning Corporation. TECHNO GI is a trademark of TECHNOGI SpA. VELCRO is a registered trademark of Velcro Industries. YKK is a registered trademark of YKK Corporation. YUASA is a registered trademark of Yuasa Batteries Inc. Brembo Brake Systems is a registered trademark of Brembo SpA. GARMIN and ZUMO are trademarks of Garmin Ltd. AKRAPOVIC EXHAUST SYSTEM TECHNOLOGY is a registered trademark of Akrapovic d.d. SHAD is a trademark of NAD S.L. CYCLOPS is a registered trademark of CyclopsGear. RoadThunder and MTX are registered trademarks of MTX Audio. Ogio is a registered trademark of Madison, a division of H Young Ltd. All other trademarks are the property of their respective owners. All vehicles presented in this brochure are fully accessorized and may differ from what is available in stores. Prices, if shown, are based on Manufacturer Suggested Retail Prices. Dealers may sell for a different price. For Canada and US, taxes are not included. Depending on location, products are distributed by BRP US Inc., Bombardier Recreational Products Inc., BRP European Distribution SA, BRP Finland Oy, BRP Australia Pty Ltd. or Bombardier Recreational Products Motores da Amazonia Ltda. BRP reserves the right, at any time, to discontinue or change specifications, prices, designs, features, equipment without incurring obligation. Printed in Canada.

CAN-AM MODELS

CAN-AM RYKER >

On a Can-Am Ryker, every ride is a thrill ride. With a lower seating position, you'll feel one with the road, so you can tackle tight turns, own every curve, and challenge every limit.



CAN-AM SPYDER F3 >

Unreal performance, comfort that pushes you further, muscular design, and a world of open road. With a Spyder F3 growling beneath you, true open-air freedom is yours to be had.



WHICH MODEL FITS YOU THE BEST?



CAN-AM SPYDER RT ^

Around every bend and at the end of every horizon, there's a new luxury to discover. This ultimate touring vehicle, with its premium comfort and storage for two, won't just get you there, it'll keep you determined for more.

MODELS	RYKER	RYKER RALLY EDITION™	SPYDER F3	SPYDER F3-S
Riding Length	▲	▲	▲ ▲	▲ ▲
Solo or 2-up	👤**	👤**	👤**	👤 👤
Storage	👜**	👜**	👜	👜
Audio	None	None	None**	None**
Engine	Rotax® 600 ACE™ or Rotax 900 ACE	Rotax 900 ACE	Rotax 1330 ACE	Rotax 1330 ACE
Transmission	Automatic	Automatic	Semi-automatic	Semi-automatic or Manual
Price (USD)	Starting at \$8,499*	Starting at \$11,499*	Starting at \$15,999*	Starting at \$17,499*

*Transport and preparation not included. **Upgrade possible via accessories.

MODELS	SPYDER F3-T	SPYDER F3 LIMITED	SPYDER RT	SPYDER RT LIMITED
Riding Length	▲ ▲ ▲	▲ ▲ ▲ ▲	▲ ▲ ▲ ▲	▲ ▲ ▲ ▲
Solo or 2-up	👤 👤	👤 👤 + COMFORT	👤 👤	👤 👤 + COMFORT
Storage	👜 👜	👜 👜 👜 👜	👜 👜 👜	👜 👜 👜 👜
Audio	🔊 🔊 🔊 🔊	🔊 🔊 🔊 🔊 🔊 🔊	🔊 🔊 🔊 🔊	🔊 🔊 🔊 🔊 🔊 🔊
Engine	Rotax 1330 ACE	Rotax 1330 ACE	Rotax 1330 ACE	Rotax 1330 ACE
Transmission	Semi-automatic	Semi-automatic	Semi-automatic	Semi-automatic
Price (USD)	Starting at \$21,499*	Starting at \$24,499*	Starting at \$23,299*	Starting at \$27,299*

RYKER



KEY FEATURES	CAN-AM RYKER		
Model	Ryker	Ryker	Ryker Rally Edition
Engine	Rotax® 600 ACE™ in-line 2 cylinders, liquid-cooled with electronic fuel injection and electronic throttle control	Rotax 900 ACE in-line 3 cylinders, liquid-cooled with electronic fuel injection and electronic throttle control	Rotax 900 ACE in-line 3 cylinders, liquid-cooled with electronic fuel injection and electronic throttle control
Power	50 hp (37.3 kW) @ 7,300 RPM	82 hp (61.1 kW) @ 8,000 RPM	82 hp (61.1 kW) @ 8,000 RPM
Torque	36.7 ft-lb (49.7 Nm) @ 6,000 RPM	58.3 ft-lb (79.1 Nm) @ 6,500 RPM	58.3 ft-lb (79.1 Nm) @ 6,500 RPM
Transmission	Automatic (CVT) with reverse	Automatic (CVT) with reverse	Automatic (CVT) with reverse
Front Suspension	SACHS® Twin-tube coil-over shocks	SACHS® Twin-tube coil-over shocks	KYB® HPG with preload adjustment
Rear Suspension	SACHS twin-tube coil-over shock with preload adjustments	SACHS twin-tube coil-over shock with preload adjustments	KYB HPG with remote reservoir 4-position compression adjustable damping and preload adjustment
L x W x H	92.6 x 59.4 x 41.8 in. (2,352 x 1,509 x 1,062 mm)	92.6 x 59.4 x 41.8 in. (2,352 x 1,509 x 1,062 mm)	92.6 x 59.4 x 41.8 in. (2,352 x 1,509 x 1,062 mm)
Dry Weight	270 kg (594 lb)	280 kg (616 lb)	285 kg (627 lb)
Cargo	Glove box – 1.85 gal (7 L)	Glove box – 1.85 gal (7 L)	Glove box – 1.85 gal (7 L)
Fuel Capacity	5.28 gal (20 L)	5.28 gal (20 L)	5.28 gal (20 L)
Standard Features	Choice of Classic Panel Kit 4.5" Digital Display Vehicle Stability System Dual USB Plug Tool-free UFit System	Choice of Classic Panel Kit 4.5" Digital Display Vehicle Stability System Dual USB Plug Tool-free UFit System Driving modes: Eco Mode and Sport Mode	Choice of Classic Panel Kit 4.5" Digital Display Vehicle Stability System Dual USB Plug Tool-free UFit System Driving modes: Eco Mode, Sport Mode, Rally Mode Rally Tires Reinforced Rims Front Grille Protection Skid Plate Hand Guards Rear Carrying Structure Rally Seat

Let our customized versions of these Can-Am Ryker serve as inspiration for creating your own! How would you build yours?

RYKER INSPIRED LOOK

RYKER RALLY EDITION INSPIRED LOOK



- 1 219400948 **CLUSTER RELOCATOR**
- 2 219400800 **MAX MOUNT**
- 3 219400813 **SPORT HANDLEBAR**
- 4 219400965 **RYKER LinQ[®] RACK**
- 5 219400964 **LinQ THERMAL BOX**

- 6 219400848 **LED AUXILIARY LIGHT**
- 7 219400920 **WHEEL ACCENTS**
- 8 219400982 **WHEEL DECALS**
- 9 219400877 **CARBON BLACK HOOD**
- 10 219400809 **CARBON BLACK PANELS**

- 1 219400947 **FRONT GRILLE TRIMS**
- 2 219400795 **DRIVER COMFORT SEAT**
- 3 219400750 **PASSENGER COMFORT SEAT**
- 4 219400801 **PASSENGER SHORT RAIL**
- 5 219400894 **HANDGUARD DEFLECTORS**
- 6 219400820 **HANDGUARD LIGHTING**

- 7 219400923 **LIQUID STEEL PANELS**
- 8 219400863 **A-ARM PROTECTOR**
- 9 219400999 **RADIATOR PROTECTOR**
- 10 219400762 **TANK BAG**
- 11 219400817 **SPLASH GUARDS**
(Not visible on the image above)

You're a click away from a custom Can-Am Ryker. Go to: CANAMONROAD.COM/BUILDYOUROWN

You can finance all your accessories with the purchase and financing of your Can-Am Ryker. Ask your Can-Am On-Road dealer for all the details.

PANELS & HOODS

CLASSIC PANELS

- An efficient and practical customization option.
- Road ready and rugged, and a snap to install.
- Matches Classic Hood Accent.
- Remarkably simple to install or remove.

All Ryker models

- 219400803 · Intense Black Gloss finish
- 219400804 · Adrenaline Red Gloss finish
- 219400928 · Yellow Shock Gloss finish

\$99.99



EPIC PANELS

- Optimized premium customization for a look that suits the ride.
- Designed to be easy-on, easy-off, and easy to love!
- Total flexibility with a perfect fit and vehicle match.
- Complements the Epic Hood.
- Painted color for exceptional luminosity and a premium look.

All Ryker models

- 219400805 · Immortal White High-gloss finish
- 219400809 · Carbon Black Satin finish
- 219400923 · Liquid Steel High-gloss finish

\$249.99



CLASSIC HOOD ACCENT

- Add a little oomph up front!
- Installs over stock hood in minutes.
- Built to last.
- Matches Classic Panels.
- Incompatible with the LED Auxiliary Light (219400848).

All Ryker models

- 219400873 · Intense Black Gloss finish
- 219400874 · Adrenaline Red Gloss finish
- 219400875 · Yellow Shock Gloss finish

\$49.99



EPIC HOOD

- Distinctive hood-styling enhancement.
- Easily installs and removes in minutes.
- Matches Epic Panels.
- Painted color for exceptional luminosity and a premium look.

All Ryker models

- 219400876 · Immortal White High-gloss finish
- 219400877 · Carbon Black Satin finish

\$199.99



New EXCLUSIVE PANEL KIT

- Stand out, and stand up for originality.
- Innovative easy installation.
- Engineered to fit right and fit tight.
- As durable as they are attractive.
- Limited Edition kit includes hood accent.
- Limited Edition kit hood accent incompatible with the LED Auxiliary Light (219400848).

All Ryker models

- 219400943 · Racer Red - Limited Edition - High-gloss finish
- 219401006 · Heritage White II - Limited Edition - High-gloss finish
- 219401015 · Liquid Titanium - Limited Edition - Satin finish
- 219400941 · Ruby Black - Limited Edition - Satin finish
- 219400942 · Urban Camo - Limited Edition - Satin finish
- 219401005 · Supersonic Green - Limited Edition - High-gloss finish

\$349.99



HANDLEBARS



SPORT HANDLEBAR

- Performance-focused straight handlebar design.
- Ideal for the more aggressive rider.

All Ryker models

219400813

\$99.99



CROSS-STYLE HANDLEBAR

- Optimizes ergonomics for superior comfort, confidence, control and endurance.

All Ryker models

219400847

\$99.99



SPORT GRIPS

- Improve grip for a better, more confident ride.
- Comfortable ergonomic texture.
- Deliver exceptional comfort on longer journeys.

All Ryker models

- 219400810 · Black
- 219400919 · Adrenaline Red

\$34.99



SEATS & BACKRESTS

New SOLO DRIVER COMFORT SEAT

- Two-tone polyurethane-skin Solo Driver Comfort Seat.
- Fully waterproof, it seats the driver an inch higher while being both two inches wider and longer, resulting in added legroom.
- Incompatible with the MAX Mount (219400800) and Rear Spoiler (219400869, 219400870, 219400871).

All Ryker models except Rally Edition (Additional parts required for Rally Edition — See instruction sheet)

219400962

\$334.99



DRIVER COMFORT SEAT

- Cut-and-sew upholstery over padding for extra driver comfort.
- Wider and higher than stock seat.

All Ryker models

219400795

\$299.99



PASSENGER COMFORT SEAT

- Cut and sew upholstery over generous padding for added comfort.
- Wider and longer than the Passenger Seat (219400842).
- Complete kit includes handles and retractable pegs.
- The MAX Mount (219400800) is required for installation.
- Complements the Driver Comfort Seat (219400795).

All Ryker models

219400750

\$409.99



PASSENGER SEAT

- Designed to transform a 1-up to a 2-up configuration in minutes.
- Complete kit includes handles and retractable pegs.
- The MAX Mount (219400800) is required for installation.
- Pegs allow VSS passenger calibration when flipped out.
- Same material than stock seat.

All Ryker models

219400842

\$289.99



FOLDABLE PASSENGER BACKREST

- Cast-aluminum construction for added strength.
- Mid-lumbar support offers extra passenger comfort.
- Conveniently folds away providing better esthetics when not in use.
- Passenger Seat (219400842) or Passenger Comfort Seat (219400750) required for installation.

All Ryker models

219400843

\$299.99



New 1-UP DRIVER BACKREST

- Installs or removes in an instant.
- Designed to enhance essential lumbar support.
- Max Mount (219400800) is required for installation.
- Compatible with LinQ Top Case (219400764).
- Incompatible with Ryker LinQ Rack (219400965), Passenger Seat (219400842), Passenger Comfort Seat (219400750).

All Ryker models

219400960

\$199.99



MAX MOUNT

- Easy to install and remove road-rugged one-piece cast aluminum construction.
- Compatible with LinQ Top Case (219400764).
- Required for the installation of Passenger Seat (219400842), Passenger Comfort Seat (219400750), LinQ Top Case (219400764), or Ryker LinQ Rack (219400965).
- Stock equipment on Rally Edition model.

All Ryker models

219400800

\$299.99



MAX MOUNT TRIM

(Not illustrated)

- Stylish way to round out the appearance when no Passenger Seat (219400842) or Passenger Comfort Seat (219400750) is installed.
- Robust injection-molded polypropylene construction.
- Blends in perfectly with body styling and vehicle finish.
- The MAX Mount (219400800) is required for installation.
- Stock equipment on Rally Edition model.

All Ryker models, except Rally Edition

219400939

\$14.99

WIND PROTECTION

ADJUSTABLE SPORT WINDSHIELD

- Enjoy extra protection from upper-body wind blast.
- Provides added comfort and enhanced aerodynamic slip.
- Innovative flip-lever design allows for easy adjustments in infinite positions over 3" stroke.
- Complete with integrated lower deflector and matching aluminum support.

All Ryker models

219401023

\$204.99



HANDGUARD DEFLECTORS

- Offer additional hand protection in all road conditions.
- Engineered for impact resistance and durability.
- Added comfort means added endurance.
- Require Aluminum Handguards (219400998) for installation.

All Ryker models

219400894

\$69.99



ALUMINUM HANDGUARDS

- Extra protection for the hands!
- Add an exciting adventure look.
- Attractive wrap-around aluminum construction.
- Required for installation of Handguard Deflectors (219400894) and Handguard Accent Lighting (219400820).
- Stock equipment on Rally Edition model.

All Ryker models

219400998

\$79.99



CARGO & STORAGE



New RYKER LinQ RACK

- Designed to accommodate a wide range of BRP LinQ 16" accessories.
- Mounting system allows it install quickly and easily onto the MAX Mount.
- The MAX Mount (219400800) is required for installation.

All Ryker models

219400965

\$199.99



New LinQ TOOL HOLDERS

- Innovative swivel latch allows it to securely grip objects such as tools or fishing rods in a variety of positions!
- The Ryker LinQ Rack (219400965) is required for installation.
- Sold in pairs.

All Ryker models

715003059

\$49.99





New LinQ THERMAL BOX

- Versatile, road-friendly, rotomolded-build LinQ Thermal Box designed to keep things hot or cold, and always ready for when you need them.
- Its expansive 4.2 Gal (16 L) capacity lets you cater to any size hunger or thirst whatever the length of the ride.
- The Ryker LinQ Rack (219400965) is required for installation.

All Ryker models

219400964

\$304.99

New LinQ SPORT BAG

- Our 4.5 Gal (17 L) LinQ Sport Bag holds everything in while keeping the weather out!
- The perfect place to keep wallets, water bottles, smartphones and jackets safe and secure.
- Constructed with a sturdy rigid bottom with semi-rigid top.
- The Ryker LinQ Rack (219400965) is required for installation.

All Ryker models

860201678

\$174.99

New LinQ DRY BAG

- LinQ Dry Bag offers 10.6 Gal (40 L) of fully-waterproof adjustable storage for your essentials.
- Its roll-top design secures your gear snugly, while a heavy-duty rigid plastic base and foam-lined bottom offer additional protection for the long haul.
- An integrated handle allows for easy transportation on or off the vehicle.
- Includes two LinQ Cargo bases.
- The Ryker LinQ Rack (219400965) is required for installation.

All Ryker models

715002875

\$189.99

New LinQ SR21 TUNNEL BAG

- Semi-rigid expandable LinQ Tunnel Bag offers a roomy 5.5 Gal (21 L) capacity.
- Convenient quick and easy tool-less LinQ installation and removal.
- The Ryker LinQ Rack (219400965) is required for installation.

All Ryker models

860201740

\$189.99

LinQ TOP CASE

- 4.2 Gal (16 L) of rugged, securely mounted roll-top weatherproof storage.
- Quick and easy toolless LinQ system – removes as effortlessly as it installs.
- The MAX Mount (219400800) is required for installation.
- Incompatible with Passenger Seat (219400842) or Passenger Comfort Seat (219400750).

All Ryker models

219400764

\$204.99

SHAD⁺ HARD SADDLEBAG

- Shock-resistant storage with enough room for a 2XL full face helmet equipped with a communication system (Capacity: 9.5 Gal / 36 L).
- Robust 3-point mount for added stability, security, and peace of mind.
- Simple single-bag right-side installation.
- Saddlebag Rack (219400856) is required for installation.

All Ryker models

219400844

\$244.99

SHAD SADDLEBAG LINER

- Designed expressly for SHAD Hard Saddlebag (219400844) to provide extra convenience.
- Includes integrated carrying handle and a shoulder strap.

All Ryker models

219401074

\$49.99

HELMET BAG

- Integrated helmet storage solution.
- Allows to lock helmet onto seat.
- Anti-theft device for added peace of mind (padlock not included).
- Conveniently doubles as rain guard for seat.
- Can mount on Passenger Seat (219400842).
- Conveniently store in front bin.

All Ryker models

219400765

\$69.99

SADDLEBAG RACK

- Ultra-sturdy long-distance-durable aluminum construction.
- Required for installation of SHAD Hard Saddlebag (219400844).
- Integrated and clean look when SHAD Hard Saddlebag is not installed.

All Ryker models

219400856

\$99.99

TANK BAG

- Safely and securely stow away keys, wallet, ID and more (Capacity: 0.75 Gal / 3 L).
- Integrated mobile phone holder.
- Convenient easy-access storage at your fingertips.
- Secure magnetic holding system with extra safety buckles.

All Ryker models

219400762

\$99.99

LIGHTS & ELECTRICAL ACCESSORIES

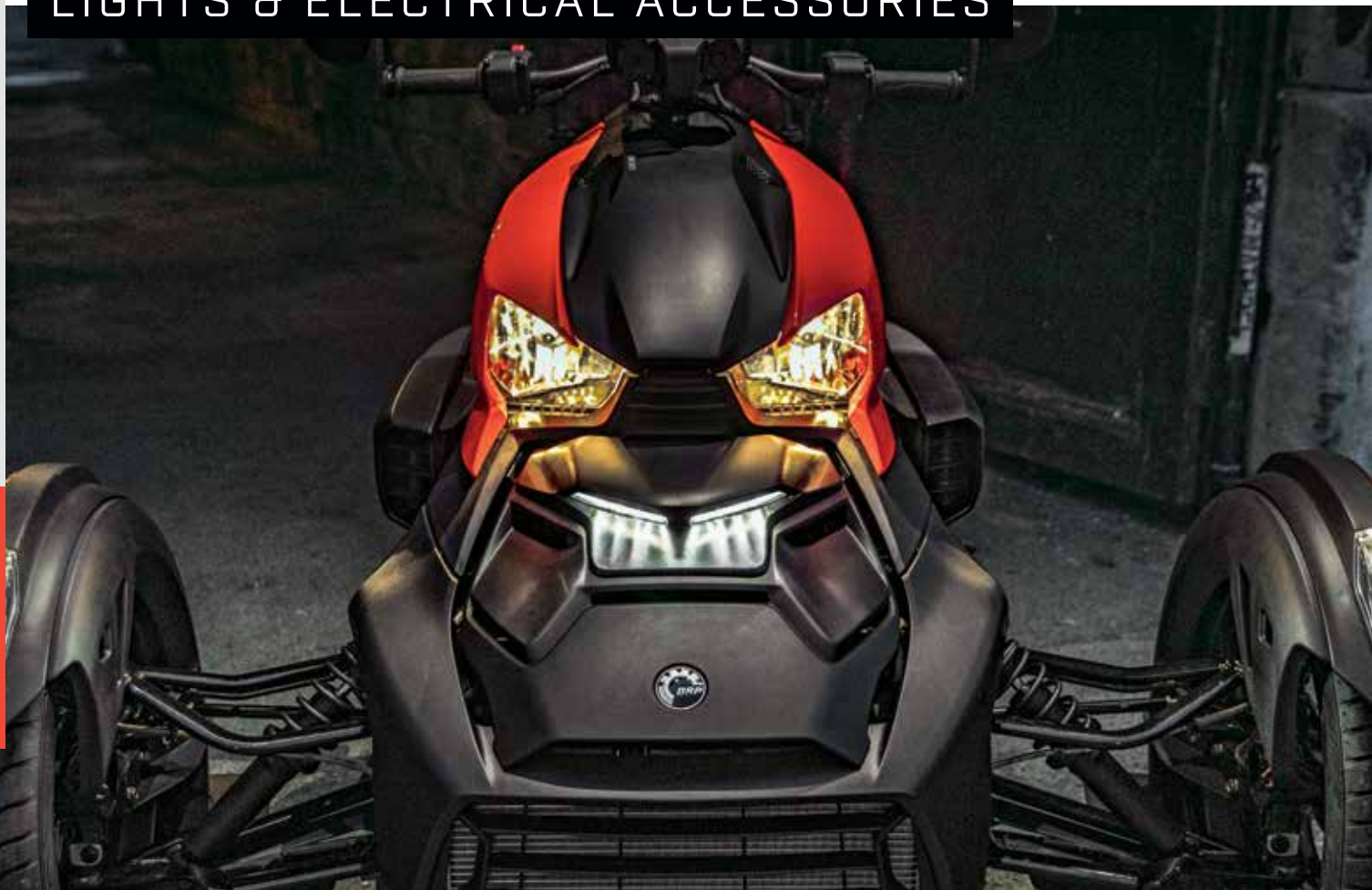

LED AUXILIARY LIGHT

- Delivers an extra 2,500 lumens of light.
- Enjoy a more visible night-riding experience.
- Fully-integrated design blends in seamlessly with your vehicle.
- Incompatible with the Classic Hood Accent and Limited Edition Kit hood accent.
- Not EC compliant.

All Ryker models

219400848

\$299.99



HANDGUARD LIGHTING

- Customize your night rides with a uniquely personal touch.
- Adds distinctive flair and style to the Aluminum Handguards.
- Requires Aluminum Handguards (219400998) for installation.
- Not EC compliant.

All Ryker models

219400820

\$134.99



SMARTPHONE HOLDER

- RAM® Mount X-Grip system ensures secure smartphone attachment.
- Soft rubber endpoints protect device finish.
- Practical, convenient and engineered for travel on any road.
- Adapts to any phone size.
- Incompatible with the GPS Holder (219400796/219400940).

All Ryker models

219400841

\$84.99



GPS HOLDER KIT

- GPS Garmin® Zumo® 590 mount.
- Installs on the right handlebar via the RAM mount system and sits high for optimal visibility.
- Easily adjusts along both axes to minimize glare and reflected light.
- Incompatible with Smartphone Holder (219400841).
- Includes electrical harness.

All Ryker models

219400796

\$224.99



GPS HOLDER (WITHOUT HARNESS)

(Not illustrated)

- GPS Garmin Zumo 590 mount.
- Installs on the right handlebar via the RAM mount system and sits high for optimal visibility.
- Easily adjusts along both axes to minimize glare and reflected light.
- Incompatible with Smartphone Holder (219400841).
- Does not include electrical harness.

All Ryker models

219400940

\$179.99

CUSTOM ACCESSORIES

New RALLY FENDER

- Give your ride that distinctive look of adventure with the Rally Fender.
- Stock on Rally Edition model.

All Ryker models

219400963

\$99.99



New MONO SEAT COWL

- Stylish Mono Seat Cowl transforms your ride into a sporty 1-up configuration while offering added protection to the tail section of our MAX Mount (219400800).
- Ultra-high-quality injection-molded scratch-resistant construction built for the road and made for mile after mile of solo adventure.
- Incompatible with Ryker LinQ Rack (219400965), Passenger Seat (219400842), Passenger Comfort Seat (219400750) and LinQ Top Case (219400764).

All Ryker models

219401001

\$99.99



New CLUSTER RELOCATOR

- Moves the cluster forward, replacing the glove box, while its integrated spoiler lends it a clean, sporty look, all without impacting cluster visibility.
- Incompatible with Adjustable Sport Windshield (219401023) and Gauge Spoiler (219400818).

All Ryker models

219400948

\$289.99



New FRONT GRILLE TRIMS

- The Front Grill Trims are a great way to give the ultimate excitement ride that ultimate adventure look!
- Mounting on each side of the front grille, they're a stylish way to inject a performance look and feel that blend in perfectly with our other Rally accessories.

All Ryker models

219400947 · Aluminum

\$229.99



REAR SPOILER

- Great looking rear spoiler adds style to your vehicle.
- Easy to install.
- Incompatible with the MAX Mount (219400800) (2-up configuration).
- High-gloss finish.
- Matches Classic Panels.

All Ryker models, except Rally Edition

219400869 · Intense Black
219400870 · Adrenaline Red
219400871 · Yellow Shock

\$59.99



GAUGE SPOILER

- Simple, effective aerodynamic tweak.
- Lends a sporty look that's easily customized with Gauge Spoiler Decals.
- Clips on without tools for quick, convenient installation.

All Ryker models

219400818

\$79.99



WHEEL ACCENTS

- Easy-clip wheel accents for hassle-free customization.
- Add prominence and a fresh new look to your vehicle.
- Even more impressive when paired with Wheel Decals.
- Kit of 15 Wheel Accents.

All Ryker models, except Rally Edition

219400825 · Intense Black
219400920 · Adrenaline Red

\$49.99



GAUGE SPOILER DECAL

- Easy-to-apply peel and stick customization for Gauge Spoiler (219400818).
- Enhances the appearance of your vehicle.

All Ryker models

219400916 · Immortal White
219400917 · Adrenaline Red
219400918 · Army Green
219400936 · Haze Blue
219400937 · Orange Blaze
219400938 · Electric Yellow
219400977 · Urban Camo
219401009 · Supersonic Green
219401016 · Liquid Titanium **New**

\$29.99



WHEEL DECALS

- The perfect road-ready eye candy designed to enhance the look of your ride.
- Easy-to-apply decals made for all your adventures.
- Pack a punch when combined with the Wheel Accents.
- Kit of 3 Wheel Decals.

All Ryker models, except Rally Edition

219400861 · Immortal White
219400921 · Adrenaline Red
219400922 · Army Green
219400933 · Haze Blue
219400934 · Orange Blaze
219400935 · Electric Yellow
219400982 · Urban Camo
219401010 · Supersonic Green
219401017 · Liquid Titanium **New**

\$29.99



RIDE PROTECTION



New RADIATOR PROTECTOR

- Designed to deflect small rocks and other common road debris, it's your first line of defense against those small road hazards that can have a big effect on the look of your vehicle.
- Fully compatible with A-Arm Protectors (219400863).

All Ryker models

■ 219400999 · Aluminum

\$129.99



A-ARM PROTECTOR

- Offers excellent protection on all road surfaces.
- Anodized aluminum for superior corrosion resistance.
- Fully compatible with Splash Guards (219400817).

All Ryker models

■ 219400863 · Aluminum

\$134.99



SPLASH GUARDS

- Simple and innovative design that works to protect against lower body splashing.
- Fully compatible with A-Arm Protectors (219400863).

All Ryker models

■ 219400817 · Black

\$154.99



New RYKER LEARNING KEY

- Designed expressly for the Can-Am Ryker 900, the Learning Key is an excellent way for new drivers to get up to speed on our 3-wheel models.
- Top speed is limited to 56 mph (90 km/h) while still allowing for operation in Eco, Sport and Rally modes!

Ryker models equipped with the 900 ACE engine only

219401020

\$54.99



KNEE PADS

- Soft closed-cell polyurethane construction designed for enhanced knee comfort.
- Quick and convenient tool-less installation.
- Provide additional grip.

All Ryker models

219400833

\$99.99



New LOCKING PARKING BRAKE LEVER

- One of the few accessories designed to stop your ride from moving, our safety-first Locking Parking Brake Lever means it stays put when parked to ensure your peace of mind.

All Ryker models

219401021

\$24.99



SUSPENSION



FOX⁺ PERFORMANCE SERIES REAR SUSPENSION

- QS3 (Quick Switch) compression adjustment lets you custom-tune your ride for better comfort and handling.
- Works with the flip of a switch.
- Choose from precalibrated soft, medium, and firm settings according to driving conditions, passengers, and individual performance requirements.
- Features a spring preload adjustment.
- Black anodized 6061 aluminum alloy body with remote reservoir.
- Perfect for frequent 2-up or aggressive riding.

All Ryker models, except Rally Edition

219400799

\$819.99



FOX PERFORMANCE SERIES FRONT SUSPENSION

- QS3 (Quick Switch Rebound) adjustment lets you custom-tune your ride for better comfort and handling.
- Works with the flip of a switch.
- Choose from precalibrated soft, medium, and firm rebound settings according to driving conditions and individual performance requirements.
- Features a spring preload adjustment.
- Black anodized 6061 aluminum alloy body.

All Ryker models, except Rally Edition

219400798

\$924.99



SWAYBAR

- Helps reduce roll while heightening control and responsiveness while cornering.
- Enjoy a sportier, more confident ride.
- 33% stiffer than stock equivalent.

All Ryker models

219400819

\$154.99



2-UP REAR SPRING

- (Not illustrated)
- Stiffer rear springs.
- Recommended for occasional and frequent 2-up riding.
- Incompatible with the FOX Performance Series Rear Suspension (219400799).

All Ryker models, except Rally Edition

219400974

\$69.99

COVERS

OUTDOOR COVER

- Rugged all-weather protection perfect for temporary vehicle storage.
- Ultra-durable solution-dyed, mildew-resistant 100-denier polyester construction.
- Easy to maintain.
- Equipped with anti-scratch lining.
- Ample sized to accommodate windshield and any accessory.

All Ryker models

■ 219400797 · Black

\$179.99



New INDOOR COVER

- Our fully-extensible polyester Indoor Cover is the ideal solution to keep your vehicle clean until you're ready to hit the road and clock some miles.
- Accommodates all Can-Am accessories!
- Suitable for indoor use only.

All Ryker models

■ 219400961 · Black

\$119.99



SPYDER F3



KEY FEATURES	CAN-AM SPYDER F3			
	Steel Black Metallic	Monolith Black Satin Liquid Titanium	Pearl White Liquid Titanium	Steel Black Metallic Liquid Titanium Magma Red Metallic
Model	Spyder F3	Spyder F3-S	Spyder F3-T	Spyder F3 Limited
Engine	Rotax 1330 [®] ACE™ in-line 3 cylinders, liquid-cooled with electronic fuel injection and electronic throttle control	Rotax 1330 ACE in-line 3 cylinders, liquid-cooled with electronic fuel injection and electronic throttle control	Rotax 1330 ACE in-line 3 cylinders, liquid-cooled with electronic fuel injection and electronic throttle control	Rotax 1330 ACE in-line 3 cylinders, liquid-cooled with electronic fuel injection and electronic throttle control
Power	105 hp (78 kW) @ 6,000 RPM	115 hp (86 kW) @ 7,250 RPM	115 hp (86 kW) @ 7,250 RPM	115 hp (86 kW) @ 7,250 RPM
Torque	96 lb-ft. (130 Nm) @ 5,000 RPM	96 lb-ft. (130 Nm) @ 5,000 RPM	96 lb-ft. (130 Nm) @ 5,000 RPM	96 lb-ft. (130 Nm) @ 5,000 RPM
Transmission	6-speed semi-automatic with reverse (SE6)	6-speed manual with reverse (SM6) or 6-speed semi-automatic with reverse (SE6)	6-speed semi-automatic with reverse (SE6)	6-speed semi-automatic with reverse (SE6)
Front Suspension	SACHS [®] Big-Bore shocks	Gas Charged FOX [®] PODIUM	SACHS Big-Bore shocks	SACHS Big-Bore shocks
Rear Suspension	SACHS shock	SACHS shock	SACHS shock with manual air preload adjustment	SACHS shock with automatic air preload adjustment
L x W x H	104 x 58.9 x 43.3 in. (2,642 x 1,497 x 1,099 mm)	104 x 58.9 x 43.3 in. (2,642 x 1,497 x 1,099 mm)	102.2 x 58.9 x 48.9 in. (2,596 x 1,497 x 1,241 mm)	102.2 x 58.9 x 48.9 in. (2,596 x 1,497 x 1,241 mm)
Wheelbase	67.3 in. (1,709 mm)	67.3 in. (1,709 mm)	67.3 in. (1,709 mm)	67.3 in. (1,709 mm)
Seat Height	26.6 in. (675 mm)	26.6 in. (675 mm)	26.6 in. (675 mm)	26.6 in. (675 mm)
Fuel Capacity	7.1 Gal (27 L)	7.1 Gal (27 L)	7.1 Gal (27 L)	7.1 Gal (27 L)
Cargo	6.5 Gal (24.4 L)	6.5 Gal (24.4 L)	6.5 Gal (24.4 L)	6.5 Gal (24.4 L)
Standard Features	4.5 in. Digital Display Refined Front Fenders with Integrated LED Lights	7.6 in. Digital Display Refined Front Fenders with Integrated LED Lights Sport Mode Cruise Control F3-S Special Series model includes all of the F3-S standard features plus: Large Panoramic 7.8 in. LCD Color Display with BRP Connect, a Mono Seat Cowl and Super Sport Grille *Only available with 6-speed semi-automatic transmission with reverse (SE6). Passenger seat also comes standard as a separate part.	Large Panoramic 7.8 in. LCD Color Display with BRP Connect, allowing for the integration of vehicle-optimized apps Refined Front Fenders with Integrated LED Lights BRP Audio 4-Speaker Sound System Audio Control Keypad Cruise Control USB Port Deep Black High-Gloss Calibrated for towing a Can-Am Trailer	Large panoramic 7.8 in. LCD Color Display with BRP Connect, allowing for the integration of vehicle-optimized apps Refined Front Fenders with Integrated LED Lights BRP Audio Premium 6-Speaker Sound System Audio Control Keypad Cruise Control USB Port Driver and Passenger Footboards and Heated Grips Parts and trims available in Chrome or Dark Editions LinQ [®] Compatible Top Case Calibrated for towing a Can-Am Trailer

Let our customized versions of these Can-Am Spyder serve as inspiration for creating your own! How would you build yours?

SPYDER F3-S INSPIRED LOOK



- 1 219400840 **ROADTHUNDER SOUNDBAR BY MTX[®]**
- 2 219400701 **AKRAPOVIČ SINISTER SILENCER**
- 3 219400595 **SUPER SPORT GRILLE**
- 4 219400713 **HOOD STRIPES DECAL KIT**
- 5 219400721 **SHAD[®] SADDLEBAGS**

- 6 219400747 **ROUTE 129 WINDSHIELD**
- 7 219400357 **TWIN-BLADE WHEELS**
(Check availability with your Can-Am dealer)
- 8 219400911 **ATTITUDE HANDLEBAR**
- 9 219401073 **SHAD SADDLEBAG LINERS**
(Not visible on the image above)

You're a click away from a custom Can-Am Spyder. Go to: [CANAMONROAD.COM/BUILDYOUROWN](https://canamonroad.com/buildyourown)

SPYDER F3-T INSPIRED LOOK



- 1 219400498 **DETACHABLE DRIVER BACKREST**
- 2 219400703 **DETACHABLE PASSENGER BACKREST**
- 3 219400509 **HEATED DRIVER GRIPS**
- 4 219400511 **AUXILIARY LIGHTS**
- 5 219400895 **SIGNATURE LIGHT**
- 6 219400910 **LONG REACH HANDLEBAR**

- 7 219400901 **PASSENGER FOOTBOARDS**
- 8 219400903 **DRIVER FOOTBOARDS**
- 9 219400602 **VINYL COST-TO-COAST SEAT**
- 10 219400606 **DELUXE SADDLEBAG LINERS**
(Not visible on the image above)

You can finance all your accessories with the purchase and financing of your Can-Am Spyder. Ask your Can-Am On-Road dealer for all the details.



YOUR CAN-AM SPYDER. YOUR FIT.



All Spyder F3 models feature our exclusive UFit System so you can customize an exact fit based on your height or preferred riding style.

CHOOSE FROM 5 HANDLEBAR OPTIONS

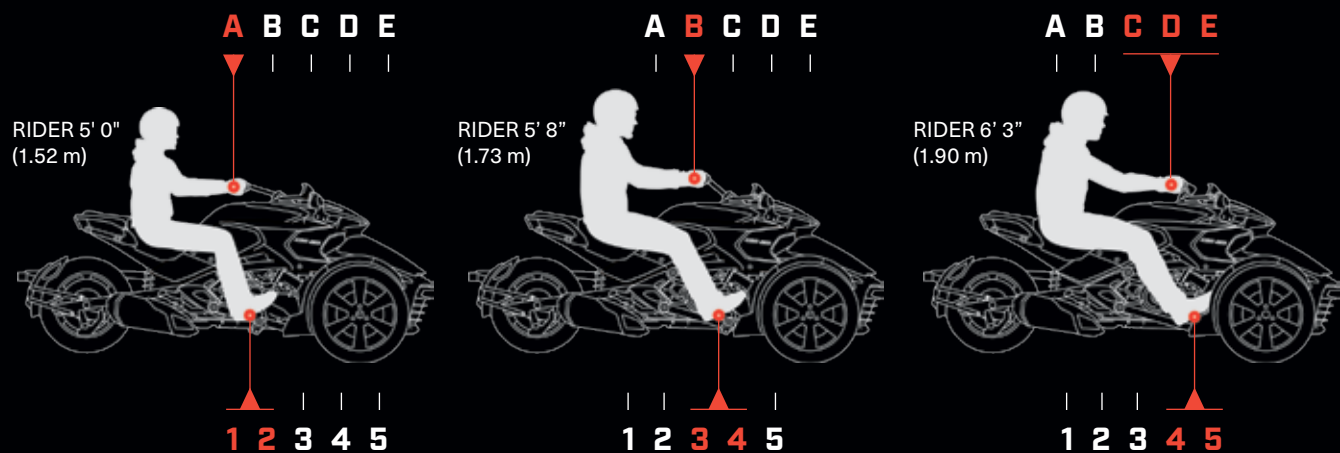

CHOOSE FROM 5 FOOTPEG POSITIONS

Find your perfect Spyder fit at UFITSYSTEM.COM or visit your dealer to test drive and ask about the showroom fit tool.

HANDLEBARS



POSITION A

SHORT REACH HANDLEBAR

- Part of the UFit System.
- Perfect for shorter riders with pegs positions 1 or 2.

All Spyder F3 models

■ 219400909 · Carbon Black

\$149.99



POSITION B

STOCK HANDLEBAR

- Part of the UFit System.
- Same shape and reach as the stock handlebar with a chrome finish.
- Fits best with pegs positions 3 or 4.

All Spyder F3 models

■ 219400547 · Chrome (Clamp Kit included)

\$459.99



POSITION C

LONG REACH HANDLEBAR

- Part of the UFit System.
- The longer reach causes the torso to lean forward, bringing the riding position closer to the console.
- Perfect for taller riders with peg positions 4 or 5.

All Spyder F3 models

■ 219400910 · Carbon Black

\$149.99



POSITION D

ATTITUDE HANDLEBAR

- Part of the UFit System.
- The shape has an impact on the driving position, leaning the torso towards the console and tilting the arm and wrist position.
- Perfect for taller riders with peg positions 4 or 5.

All Spyder F3 models

■ 219400911 · Carbon Black

\$149.99



POSITION E

DRAG BAR

- Part of the UFit System.
- Race-inspired straight bar is wide and more forward for a more aggressive riding position or tall driver.
- Perfect for taller riders with peg position 5.

All Spyder F3 models

■ 219400594 · Carbon Black

\$309.99



BRAKE & SHIFTER LINKAGES



BRAKE & SHIFTER LINKAGES

- Part of the UFit System.
- Find the best driving position for you.
- Replace stock linkage to set pegs to different positions.

All F3 SE6 models

-2 · Position 1 · 219400561

-1 · Position 2 · 219400563

+1 · Position 4 · 219400566

+2 · Position 5 · 219400571

\$29.99

All F3 SM6 models

-2 · Position 1 · 219400560

-1 · Position 2 · 219400562

+1 · Position 4 · 219400564

+2 · Position 5 · 219400565

\$49.99



FOOTBOARDS



DRIVER FOOTBOARDS

- Replace stock pegs for additional comfort.
- Come with rubber pads and mounting hardware.
- Can be positioned with the UFit System.

All Spyder F3 models

■ 219400903 · Carbon Black
\$459.99



PASSENGER FOOTBOARDS

- Replace stock pegs for additional comfort.
- Come with rubber pads and mounting hardware.

All Spyder F3 models

■ 219400902 · Chrome
■ 219400901 · Carbon Black
\$404.99 \$304.99



IDLER PULLEY

F3 IDLER PULLEY SERVICE KIT

- (Not illustrated)
- Enhances your comfort on the road by reducing vibrations generated by the belt.

All Spyder F3 models

219800431
\$35.99

SEATS & BACKRESTS



LEATHER COAST-TO-COAST SEAT

- Genuine stitched-leather seat.
- Passenger and driver seat rain cover included.
- Installs in seconds and works with both driver and passenger backrests.
- Long-distance comfort based on our renowned wide, well-shaped and generously padded driver and passenger seats capable of delivering a coast-to-coast ride.

All Spyder F3 models

■ 219400656 · Tan
\$649.99



VINYL COAST-TO-COAST SEAT

- Long-distance comfort based on our renowned wide, well-shaped and generously padded driver and passenger seats capable of delivering a coast-to-coast ride.
- Installs in seconds and works with both driver and passenger backrests.

All Spyder F3 models

219400602
\$549.99



CANNONBALL SEAT

- 2-piece driver and passenger seat.
- Installs in minutes.
- Designed with additional padding, larger support areas and integrated comfort rear pad.
- Distinctive high-end stitching pattern.
- Driver backrest ready.

All Spyder F3 models

219400497
\$579.99



2-UP CONVERSION KIT

- (Not illustrated)
- Complete passenger kit to allow 2-up riding on 2019 and up F3 base.
 - Includes passenger seat, pegs and handles.

2019 and up F3 Base models

219400975
\$369.99

DETACHABLE DRIVER BACKREST

- Generous width and height for superior lumbar support.
- Installs and removes in minutes.
- Tilt adjustable.
- Fits on production, Cannonball, Vinyl Coast-to-Coast and Leather Coast-to-Coast seats.
- Anti-theft feature.

All Spyder F3 models

219400498

\$399.99

**DETACHABLE PASSENGER BACKREST**

- Generous width and height for superior lumbar support.
- Initial installation in minutes, toolless removal in seconds.
- Anti-theft feature.
- Fits on production, Cannonball, Vinyl Coast-to-Coast and Leather Coast-to-Coast seats.
- Invisible mounting system unrecognizable when not installed.

Spyder F3, F3-S, F3-T

219400703

\$569.99

**ADJUSTABLE PASSENGER BACKREST**

- Dual axis adjustments for the backrest and cushion enable you to dial-in comfort and add up to 2" (50 mm) more passenger room.

Spyder F3, F3-S, F3-T

219400794

\$759.99

**PASSENGER SHORT RAIL**

- Sporty looking short passenger comfort rear pad.
- Installs in minutes.
- Fits on production seats.
- Doesn't fit when the Top Case with Integrated Passenger Backrest (219400897) is installed.

Spyder F3, F3-S, F3-T

219400580

\$369.99

**PASSENGER ARMRESTS**

- Adjust upwards, downwards, forwards, backwards, and outwards.
- Arm height provides up to 0.78" (20 mm) vertical adjustment.
- Complete with grip for added passenger security.
- Top Case (219400897) not required for installation or use, but recommended.
- Passenger Backrest (219400794 or 219400703) also recommended for installation.

All Spyder F3 models

219400726

\$399.99

**WINDSHIELDS & WIND PROTECTION****BLUE RIDGE WINDSHIELD**

- Made of clear 4.5 mm polycarbonate.
- Comes complete with supports and hardware.

Spyder F3, F3-S

219400746

\$399.99



HEIGHT 21.25" [54 CM]

ROUTE 129 WINDSHIELD

- Sport windshield.
- Made of 4.5 mm polycarbonate.
- Provides lower body protection.
- Comes complete with supports and hardware.

Spyder F3, F3-S

219400747

\$344.99



HEIGHT 15.5" [39 CM]

TALL BOY WINDSHIELD

- Mid-height windshield.
- Scratch-and UV-resistant hardcoat on 5 mm polycarbonate shield.
- Windshield supports included.

Spyder F3-T, F3 Limited

219400596

\$384.99



HEIGHT 20.25" [51.5 CM]

GAUGE SPOILER

- Enhances the sporty look of the Can-Am Spyder F3.
- Made of injected tinted polycarbonate.

Spyder F3, F3-S

■ 219400531 · Smoke

\$169.99

**WINDSHIELD TRIM KIT**

- Dresses up accessory windshield kits with chrome center trim.

Fits with Blue Ridge Windshield (219400746) and Route 129 Windshield (219400747)

■ 219400698 · Chrome

\$29.99



CARGO & STORAGE



BRP partners with SHAD[†], a recognized leader in the manufacture of highly-advanced motorsport bags and storage accessories. Their designs are known to be state-of-the-art, totally functional and of first-class quality, earning them the prestigious "Red Dot: Best of the Best" international award in 2015.

SHAD SADDLEBAGS FOR CAN-AM

- Patented lightweight bike-specific design.
- 3-point mount.
- Waterproof, shock-resistant.
- 9.5 Gal capacity (36 L).
- Enough room for a 2XL full face helmet equipped with a communication system.
- Unique Can-Am reflector.
- Required mounting support and hardware are sold separately (219400728 for North America, 219400727 for Europe).

Spyder F3, F3-S

219400721
\$559.99



SHAD SADDLEBAG LINERS

- Designed expressly for SHAD Saddlebags (219400721) to provide extra convenience.
- Include integrated carrying handle and a shoulder strap.
- Sold in pairs.

Spyder F3, F3-S

219401073
\$99.99



SHAD SADDLEBAGS F3 RACK

- (Not illustrated)
- Custom rack specially designed for mounting SHAD Saddlebags (219400721).
- Integrated red reflectors and necessary hardware for SHAD Saddlebags.

Spyder F3, F3-S

219400728
219400727 · Europe (Amber reflectors) EC compliant
\$249.99

SHAD REAR SEAT BAG

- 100% waterproof 3-layer (PVC-Nylon-PVC) design that's tear- and abrasion-resistant.
- 7.4 Gal (28 L) capacity.
- Foam-lined inner compartment for laptop or other valuables.
- Includes attachment straps.
- Converts to backpack, complete with chest strap.

All Spyder models

219400730
\$129.99



DELUXE SADDLEBAGS LINERS

- Complete your production saddlebags with Deluxe Saddlebags Liners.
- The easiest way to carry your items from your Can-Am Spyder saddlebag.
- Include integrated handle.

Spyder F3-T, F3 Limited

219400606
\$99.99



FRONT CARGO BAG

- Easy way to organize and tote your items in the front cargo compartment.
- Slides in and out.
- Includes integrated handle and shoulder strap.

All Spyder F3 models

219400631
\$89.99



TOP CASE WITH INTEGRATED PASSENGER BACKREST

- Fits up to two 2XL full face helmets equipped with a communication system.
- Integrated passenger backrest.
- Protective rubber carpet-lined bottom.
- Requires vehicle color matching side panels to complete the top case assembly - sold separately.

Spyder F3-T 2019 and prior

219400897
219400898 · Europe · EC certified
\$1,499.99

Spyder F3-T 2020 and up

- Quick and easy tool-less LinQ System removes as effortlessly as it installs.

219401080
219401081 · Europe · EC Certified
\$1,999.99

AVAILABLE IN FEBRUARY ONLY



TOP CASE PANEL KIT

- Vehicle-matched top case side panels.

Spyder F3-T with Top Case

- 219400758 · Steel Black Metallic
- 219400759 · Pearl White
- 219400760 · Intense Pearl Red
- 219400761 · Pure Magnesium
- 219400859 · Oxford Blue Metallic

\$199.99



TOP CASE INNER BAG

- Maximizes top case volume.
- Complete with integrated handle and shoulder strap for convenient portability.

Spyder F3-T with Top Case, F3 Limited 2017 and up, RT 2020 and up

219400748
\$129.99



INTEGRATED HELMET BAG

- Truly integrated easy-to-use helmet storage solution.
- Sturdy water-resistant construction.
- Includes elastic straps for tying down helmet bag onto seat.
- Complete with anti-theft wire for added security.

Spyder RT 2019 and prior, all Spyder F3 models

219400850
\$59.99



TOP CASE RACK

- Allows for added external storage capacity when used with netting or bungee cords.
- Sturdy stamped-aluminum construction.
- Includes integrated anchor points.

Spyder F3-T with Top Case, F3 Limited 2017 and up, RT 2020 and up

219400743
\$214.99



URBAN RACK

- Solid aluminum construction offering 0.9 Gal (3.37 L) of water-resistant storage.
- Comes with net to allow users to strap additional luggage on top.
- Pops into passenger seat space in seconds.
- Anti-theft feature.

Spyder F3, F3-S

219400493
\$419.99



F3 MONO SEAT COWL

- High-quality injection-molded part.
- Pops into passenger seat space in seconds.
- Transforms your vehicle into sporty solo configuration.
- Adds 1.25 Gal (4.73 L) of lockable water-resistant storage.

Spyder F3, F3-S

219400494
\$334.99



REAR TAIL RACK

- Robust monobloc cast-aluminum construction.
- Ideal for stowing soft bags, tents, or sleeping bags.
- Includes convenient integrated anchor points.
- Bolts securely to the vehicle frame.

Spyder F3-T, F3 Limited 2016

219400645
\$199.99



LIGHTS & ELECTRICAL ACCESSORIES



ROADTHUNDER SOUNDBAR BY MTX†

- Bluetooth® speaker with the unbeatable convenience of fingertip control.
- Rugged IP66-rated weather-resistant speaker designed for outdoor use.
- Driven by 150 watts of quality audio power.
- Seamless integration and operation from Bluetooth enabled devices.
- Includes: Input, ground and ignition wires, plus auxiliary port and 3.5" connector cable.

Note: We recommend you use 320 Kbps MP3 / 192-256 Kbps AAC / AIFF / WAV formats to match the potential of the speaker. More compressed formats will probably have degraded sound quality.

Spyder F3, F3-S

219400840

\$404.99



AUXILIARY LIGHTS

- Halogen fog lamps.
- Enhance low beam light for better visibility.
- Plug-and-play with stock harness.
- Integrated ON/OFF switch.
- Not EC compliant.

All Spyder F3 models

219400511

\$519.99



HEATED DRIVER GRIPS

- Complete heating kit with one intensity setting.
- Easy installation.
- Integrated ON/OFF switch.

Spyder F3, F3-S, F3-T

219400509

\$224.99



GARMIN® ZUMO® 590 GPS

- Features a glove-friendly and sunlight-readable 5" (12.7 cm) dual-orientation touchscreen display.
- Offers hands-free phone control and spoken directions heard in-helmet via Bluetooth® 5 technology.
- Includes an MP3 player.
- iPod® and Pandora® compatibility.
- Allows control of music right on the display.
- Rugged and tough enough to withstand fuel spills, UV rays and harsh weather.
- Offers access to real-time weather and traffic information via the smartphone link app.
- Free lifetime map updates.
- Curvy Roads Routing allows rider to find winding roads.
- GPS Holder (219400912) sold separately.
- Incompatible with 2018 RT and F3 models featuring the VIP cluster.

All Spyder models

219400512

219400699 · Europe

\$799.99



Zumo 590 GPS has the ability to link itself wirelessly to optional Garmin tire pressure sensors and the Garmin Virb video camera for enhanced GPS functionality.

GARMIN ZUMO GPS HOLDER

- Positions Garmin Zumo GPS on the center of all UFit System handlebars.
- Wiring/charging harness included.
- Incompatible with the Roadthunder Soundbar by MTX (219400840).

All Spyder F3 models

219400912

\$254.99



GPS HOLDER (WITHOUT HARNESS)

(Not illustrated)

All Spyder F3 models

219400717

\$194.99

GARMIN ZUMO GPS HOLDER (WITHOUT HARNESS)

(Not illustrated)

All Spyder F3 models

219400913

\$179.99

BOLT KIT FOR GPS HOLDER

(Not illustrated)

- Required to fit Garmin Zumo GPS Holder (219400913) on Drag Bar (219400594).

All Spyder F3 models

219400655

\$24.99

GPS HOLDER

- Sits high on right side handlebar for optimum visibility.
- Multidirectional adjustment to prevent sun glare, and adapts to any rider.
- Harness included.

All Spyder F3 models

219400749

\$224.99



POWER OUTLET KIT

- Recharges your electronic devices while riding* (smartphone, MP3, heating gear, etc.).
 - Dual port USB connectors.
 - Plug-and-play kit.
 - Simply connect under driver seat and use.
- *The power outlet is not capable of recharging all device types while riding.

Spyder RT models 2019 and prior, RS, ST, F3, F3-S

219400510 · USB

\$31.99

- Adds an extra 12V power outlet to your vehicle.
- Conveniently located in front cargo bin.

All Spyder RT models 2019 and prior, all Spyder F3 models

219400366 · 12V

\$35.99



F3-T FRONT RADIO SYSTEM

- Upgrades sound: Includes 2 woofer speakers and 2 mids (4X20 watts), USB plugs, aerial and hardware.

Spyder F3-T 2017, F3 Limited 2016

219400680

\$939.99



WHEELS

15" FAT 6 CHROME WHEELS

- Same design as Spyder F3 production wheels in PVD finish.
- Sold in pairs.

All Spyder F3 and RT models, RS, ST 2013 and up

■ 219400589 · Chrome

\$729.99



15" BONNEVILLE DISH WHEELS

- Give your Can-Am Spyder a retro look with these 15" wheels inspired by Salt Flat racers.
- Wheel nuts are hidden behind the center cap.
- Sold in pairs.

All Spyder F3 and RT models, RS, ST 2013 and up

■ 219400501 · Black

\$609.99



15" BLADE MAG WHEELS

- Unidirectional design (left and right wheel).
- Patented casting process allows a weight reduction of 2.2 lbs (1 kg) per wheel compared to stock wheels.
- Sold in pairs.

All Spyder F3 and RT models, RS, ST 2013 and up

■ 219400465 · Black

\$669.99



15" SHAMROCK WHEELS

- Add personality to your Can-Am Spyder.
- Casted, painted and machined wheels.
- Sold in pairs.

All Spyder F3 and RT models, RS, ST 2013 and up

■ 219400500 · Deep Black

\$624.99



CHROME REAR WHEEL

- 6-spoke PVD (chrome-like powder coat more resistant than regular chrome) monobloc rear wheel (hub and wheel in one piece).

All Spyder F3 and RT models, RS, ST 2013 and up

■ 219400574 · Chrome

\$669.99



15" BLADE MAG WHEELS SERVICE KIT

(Not illustrated)

- Replacement "blade" for wheels.

■ 219400542 · Left · Brushed Aluminum

■ 219400543 · Right · Brushed Aluminum

\$24.99

FENDERS

CHOPPED REAR FENDER

- Sleek, short fender shows off the massive Spyder F3 rear tire.
- Street legal and includes license plate holder, LED light and required hardware.
- License plate holder not compliant outside North America.

Spyder F3, F3-S

■ 219400597 · Carbon Black

\$439.99



LOW BROW FRONT FENDERS

- Super sleek drawn steel fenders with LED position lights integrated into the front edge.
- Include electrical harness and required hardware.
- Sold in pairs.
- LED position lights not EC compliant.

All Spyder RT models 2019 and prior, RS, ST 2013 and up, all Spyder F3 models 2018 & prior.

■ 219400502 · Carbon Black

\$959.99



CUSTOM ACCESSORIES



SUPER SPORT GRILLE

- Add an even more muscular look with this honeycomb-styled front grille with integrated front splitter.

All Spyder F3 models

■ 219400595 · Black / Can-Am Red

\$354.99



BOBBER KIT*

- Everything needed to transform a 2-up into a 1-up.
- Rear fender, tail light assembly, footrest trim, license plate support, and all necessary hardware included.
- Can also accommodate any production or accessory seat.
- * A bobbed tail increases the amount of projection from the rear tire versus a traditional fender.
- Laws vary state to state regarding rear fender tire coverage compliance. Please obey all applicable laws and regulations.

Spyder F3, F3-S

■ 219400640 · Black

■ 219400745 · Black · Europe · EC compliant

(Doesn't include rear fender and licence plate support)

\$809.99



A bobber, formerly known as a "bob-job," is a distinct style of motorcycle that typically involves stripping excess bodywork to reduce the weight and shortening, or "bobbing," the rear fender into the shape of a bobtail.

PULLEY COVER

- Replaces the stock plastic PTO (drive pulley) cover with a genuine chrome cover.

All Spyder F3 models

■ 219400557 · Chrome

\$199.99



FRAME CAPS

- Add a little bling to the frame of your vehicle.
- 4 frame caps per pack.

All Spyder F3 models

■ 219400555 · Chrome

\$129.99



TMC COVER

- Replaces the stock plastic TMC (master cylinder) cover with a genuine chrome cover.

All Spyder F3 models

■ 219400559 · Chrome

\$199.99



HANDLEBAR END CAPS

- Sold in pairs.

All Spyder models

■ 219400702 · Chrome

\$41.99





SIGNATURE LIGHT

- Creates an unmistakable, distinctive look.
- No switch, automatically turns on.
- Includes required wiring and hardware for Spyder F3 2016 models and up.
- Not EC compliant.

All Spyder F3 models

219400895 · White

\$169.99



SIGNATURE LIGHT - 2015 ADAPTER KIT

- (Not illustrated)
- Wiring harness required for installing Signature Light (219400895) on 2015 models.
- Allows the light to automatically illuminate when the engine is running.
- LED lights.

Spyder F3 2015, F3-S 2015

219400636

\$39.99

DECALS

HOOD STRIPES DECAL KIT

- Adds personality to your Can-Am Spyder F3.

All Spyder F3 models

219400711 · Can-Am Red

219400714 · Gloss White

219400713 · Matte Black

219400712 · Satin Silver

\$79.99



F3 MONO SEAT COWL STRIPES DECAL KIT

- Premium decals complement Hood Stripes Decal Kit.

Spyder F3, F3-S

219400661 · Can-Am Red

219400662 · Gloss White

219400663 · Matte Black

219400664 · Satin Silver

\$59.99



REAR TAIL STRIPES DECAL KIT

- Premium decals complement Hood Stripes Decal Kit.

Spyder F3-T, F3 Limited 2016

219400665 · Can-Am Red

219400666 · Gloss White

219400667 · Matte Black

219400668 · Satin Silver

\$49.99



SHOCKS

FOX ADJUSTABLE FRONT SHOCKS

- Feature spring-adjustable preload and wide-range externally-adjustable rebound damping for an infinite array of tuning options made to suit any riding style.
- Whether it's smooth cruising or twisting down your favorite winding road, they deliver exceptional performance, comfort, and a superior quality ride.

Spyder F3-T, F3 Limited

219400733

\$849.99

Fox' shocks have been an industry leader in high-performance shocks and racing suspensions for over 30 years.



FOX FACTORY SERIES 1.5 PODIUM R FRONT SHOCKS

- Featuring spring-adjustable preload and a wide range of externally adjustable rebound damping, the PODIUM R shocks provide an infinite array of tuning options to comfortably suit your riding style.
- Whether you're out for a mellow cruise or enjoying your favorite twisty route, the PODIUM R shocks will deliver superb performance, great comfort, and an overall quality ride.

Spyder F3, F3-S

219400515

\$849.99



FOX ADJUSTABLE REAR SHOCK

- FOX Factory Series rear shock delivers an infinite range of setup options.
- Anodized lightweight 6061-T6 aluminum body provides enhanced reliability and excellent performance.

Spyder F3, F3-S

219400734

\$649.99



AUTOMATIC REAR AIR SUSPENSION KIT

- Automatic suspension assures a smooth, comfortable ride.
- Includes air compressor and all required hardware.

Spyder F3-T, F3 Limited

219400738

\$474.99



FOX FACTORY SERIES 2.0 PODIUM RC2 REAR SHOCK

- Provides an infinite range of options for the perfect setup.
- Its anodized 6061-T6 aluminum body and remote aluminum reservoir make the lightweight PODIUM RC2 shock a reliable and awesome performer.

Spyder F3, F3-S

219400577

\$969.99



OCCASIONAL 2-UP REAR SHOCK

- Weight-bearing capacity designed for occasional 2-up use.

Spyder F3, F3-S

219400739

\$199.99



SILENCERS



Akrapovič was established in 1990 by Slovenian racer Igor Akrapovič, who during his racing career found there was a distinct lack of high-quality exhaust systems on the market available to the public.

AKRAPOVIČ SILENCERS TOP FEATURES

- Deeper, more guttural sound than stock silencer.
- Meet the most stringent standards - EPA, CARB and EC certified.
- Maintain vehicle warranty requirements.
- Easy installation.
- Exhaust fit compatible with all BRP genuine accessories.

AKRAPOVIČ SINISTER SILENCER

- 3-outlet design exclusive to Can-Am.
- Finished in bold flat black carbon and stainless steel.
- Unique Akrapovič growl.
- Akrapovič Sinister Silencer Heat Shield Replacement Kit (219400766) available.
- Not AS certified.

Spyder F3, F3-S
 ■ 219400701 · Black
\$1,109.99



AKRAPOVIČ STRAIGHT SHOT SILENCER

- Premium chromed stainless steel shell construction, end cap and heat shields.
- Not AS certified.

Spyder F3, F3-S 2015 and up (Europe: 2015-2017 only)
 ■ 219400514 · Chrome
\$1,129.99



AKRAPOVIČ SPORT TOURING 3C SILENCER

- Set your ride apart with the dynamic, deep resonant sound of an Akrapovič silencer.
- Its premium titanium and carbon fiber construction is 55% lighter than the stock model and it's been tested to meet the most stringent requirements.
- Not AS certified.

Spyder F3-T, F3 Limited, RT 2015 and up
 ■ 219400650 · Titanium · Canada / US
 ■ 219400838 · Titanium · Other countries
\$999.99



AKRAPOVIČ SINISTER SILENCER HEAT SHIELD REPLACEMENT KIT

(Not illustrated)

Spyder F3, F3-S (Service kit)
 219400766
\$199.99

COVERS

F3 LIMITED TRAILERING COVER

- Made of durable, 100% waterproof, fully-breathable 300-denier polyester.
- Easy-on / easy-off system ensures cover is secure in all trailering conditions.
- Equipped with integrated exhaust panel and no-scratch flannel windshield liner.
- Compatible with all stock and accessory seats regardless of passenger or driver backrests, passenger armrests, windshield, or top case.

F3-T (with optional top case), F3 Limited 2017 and up

■ 219400768 · Black
\$254.99



F3-T TRAILERING COVER

- Made of durable, 100% waterproof, fully-breathable 300-denier polyester.
- Easy-on / easy-off system ensures cover is secure in all trailering conditions.
- Equipped with integrated exhaust panel and no-scratch flannel windshield liner.
- Compatible with all stock and accessory seats regardless of passenger or driver backrests, passenger armrests, or windshield.
- Incompatible with top case.

Spyder F3-T, F3 Limited 2016

■ 219400751 · Black
\$234.99



OUTDOOR COVER

- Durable solution-dyed UV and mildew-resistant 100-denier polyester construction.
- Soft inner liner protects windshields up to Tall Boy Windshield (219400596).
- Compatible with F3-T with or without passenger and driver backrests.
- Also compatible with all F3 windshields.
- Incompatible with Passenger Armrests (219400726).

Spyder F3-T, F3 Limited 2016

■ 219400603 · Black
\$264.99



OUTDOOR COVER

- Durable solution-dyed UV and mildew-resistant 100-denier polyester construction.
- Inner liner protects windshield.
- Easy maintenance.

Spyder F3, F3-S

■ 219400495 · Black
\$234.99



TRAVEL COVER

- Provides protection to vehicle's top areas.
- Stows conveniently into front bin and takes up little space.
- Easy to install and remove.

Spyder F3, F3-S

■ 219400496 · Black
\$164.99



TRAVEL COVER

- Start your morning ride with a dry, clean seat.
- Protects the top surfaces of your vehicle and stows compactly in the front compartment, making it a great road trip companion.

Spyder F3-T, F3 Limited 2016

■ 219400604 · Black
\$159.99



DRIVER SEAT RAIN COVER

- 100% waterproof driver seat protection.
- Fits all stock or accessory seats.
- Compatible with Driver Backrest.
- Quick installation and removal.

All Spyder F3 models

■ 219400648 · Black
\$39.99



PASSENGER SEAT RAIN COVER

- 100% waterproof passenger seat protection.
- Fits all stock or accessory seats.
- Compatible with Passenger Backrest and Short Rail.
- Quick installation and removal.





Spyder F3, F3-S and F3-T Standard Seat, Coast-to-Coast Seat, Cannonball Seat

■ 219400649 · Black
\$34.99

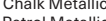

SPYDER RT

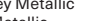

KEY FEATURES	CAN-AM SPYDER RT	
	 Chalk Metallic  Petrol Metallic	 Asphalt Grey Metallic  Chalk Metallic  Deep Marsala Metallic  Petrol Metallic
Model	Spyder RT	Spyder RT Limited
Engine	Rotax 1330 ACE in-line 3 cylinders, liquid-cooled with electronic fuel injection and electronic throttle control	Rotax 1330 ACE in-line 3 cylinders, liquid-cooled with electronic fuel injection and electronic throttle control
Power	115 hp (86 kW) @ 7,250 RPM	115 hp (86 kW) @ 7,250 RPM
Torque	96 lb-ft. (130 Nm) @ 5,000 RPM	96 lb-ft. (130 Nm) @ 5,000 RPM
Transmission	6-speed semi-automatic with reverse (SE6)	6-speed semi-automatic with reverse (SE6)
Front Suspension	SACHS Big-Bore shocks	SACHS Big-Bore shocks
Rear Suspension	SACHS shock with air preload adjustment	SACHS Shock with self-leveling air preload adjustment
L x W x H	109.3 x 61.2 x 57.6 in. (2,777 x 1,554 x 1,464 mm)	111.5 x 61.2 x 57.6 in. (2,833 x 1,554 x 1,464 mm)
Wheelbase	67.5 in. (1,714 mm)	67.5 in. (1,714 mm)
Seat Height	29.725 in. (755 mm)	29.725 in. (755 mm)
Fuel Capacity	7 Gal (26,5 L)	7 Gal (26,5 L)
Cargo	31 Gal (117 L)	47 Gal (177 L)
Standard Features	Premium LED Headlights Rider Touring Floorboards Adjustable Passenger Footboards Ultra Comfortable Seat with Lumbar Support Rider Heated Grips BRP Audio 4-Speaker Sound System Driver Heated Grips Large Panoramic 7.8" LCD Color Display with BRP Connect Audio Control Keypad Glove Box with USB Electronic Cruise Control Integrated Hard Side Luggage Adjustable Electric Windshield with Memory Calibrated for towing LinQ compatible	Premium LED Headlights Rider Touring Floorboards Adjustable Passenger Footboards Ultra Comfortable Limited Seat with Lumbar Support BRP Audio Premium 6-Speaker Sound System Large Panoramic 7.8" LCD Color Display with BRP Connect Audio Control Keypad Glove Box with USB Electronic Cruise Control Integrated Hard Side Luggage Adjustable Electric Windshield with Memory Calibrated for towing Signature LED Lights Front Cargo Light and Liner Driver and Passenger Heated Grips Driver and Passenger Heated Seats LinQ Compatible Top Case with Passenger Backrest Automatic Self-Leveling Rear Air Suspension

Let our customized versions of these Can-Am Spyder serve as inspiration for creating your own! How would you build yours?

SPYDER RT INSPIRED LOOK



- 1 219400973 RT LinQ RACK
- 2 219400964 LinQ THERMAL BOX
- 3 219400956 ADJUSTABLE SPORT WINDSHIELD

- 4 219400972 HEATED COMFORT SEAT
- 5 219400500 SHAMROCK WHEELS

You're a click away from a custom Can-Am Spyder. Go to: CANAMONROAD.COM/BUILDYOUROWN

SPYDER RT LIMITED INSPIRED LOOK



- 1 219400993 ADJUSTABLE TOURING VENTED WINDSHIELD
- 2 219400957 ADJUSTABLE DRIVER BACKREST
- 3 219400991 AUXILIARY LIGHT
- 4 219400743 TOP CASE RACK

- 5 219400958 PASSENGER ARMRESTS
- 6 219400167 SEMI-RIGID FRONT CARGO TRAVEL BAG
(Not visible on the image above)
- 7 219400172 SOFT SIDE CARGO TRAVEL BAGS
(Not visible on the image above)
- 8 219400748 TOP CASE INNER BAG
(Not visible on the image above)

You can finance all your accessories with the purchase and financing of your Can-Am Spyder. Ask your Can-Am On-Road dealer for all the details.

HANDLEBARS

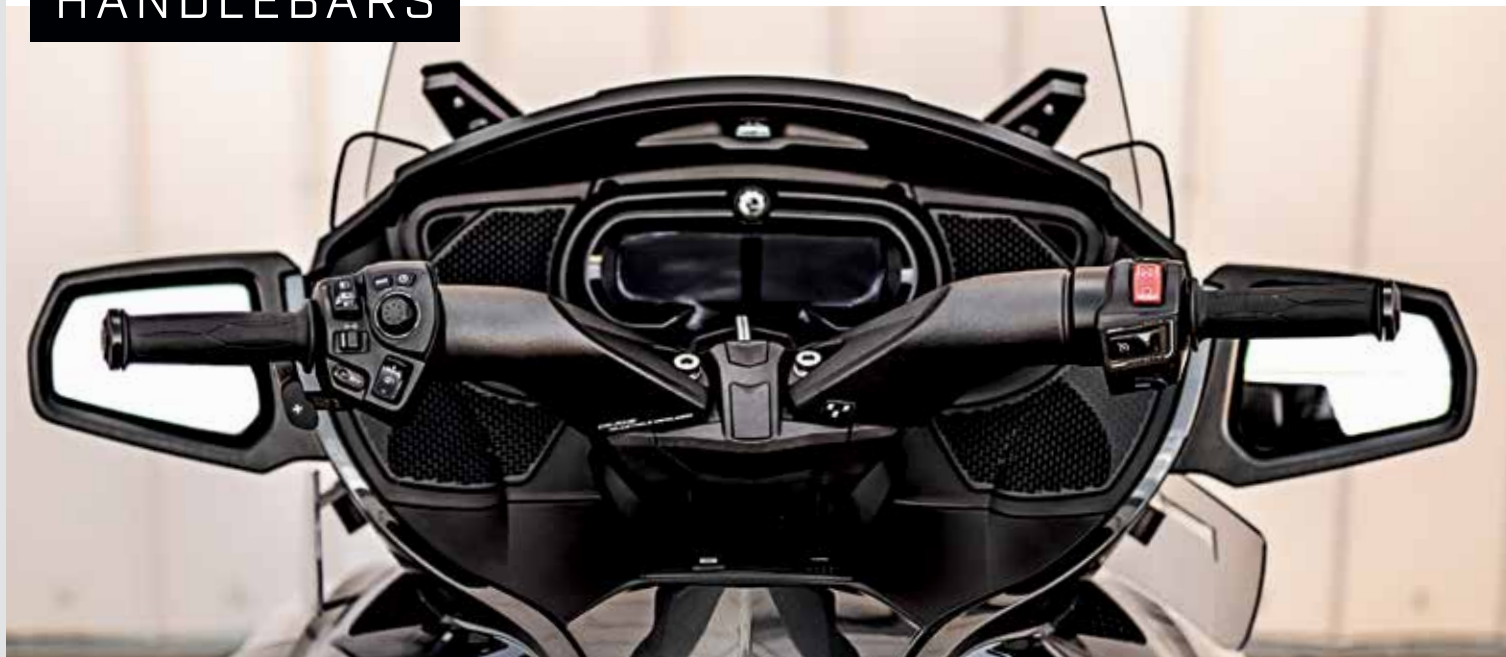

TRI AXIS ADJUSTABLE HANDLEBAR

- State-of-the-art adjustable handlebar reduces fatigue and delivers comfort for all riders thanks to unlimited adjustment possibilities.
- Three different axes allow you to adjust the handlebar in terms of height, width and arm distance.
- Left and right bars are linked together and rotate simultaneously during adjustment.
- Easy Allen key adjustment system.
- Handlebar reuses existing production handgrips, control switch, electrical and clutch cables, and sits directly on the stock steering column.

Spyder RT 2019 and prior
 219400344
\$669.99



Three different axes enable you to adjust the handlebar height, width and arm distance.

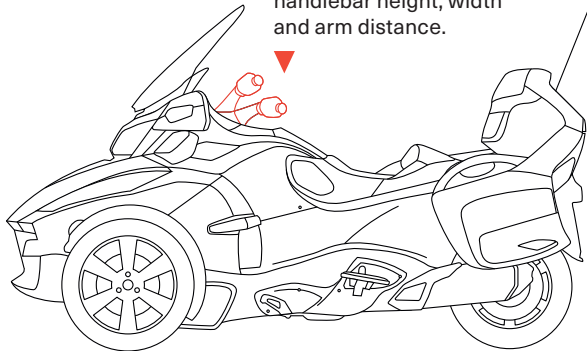

The left and right sides of the bar are linked so they're always in sync.

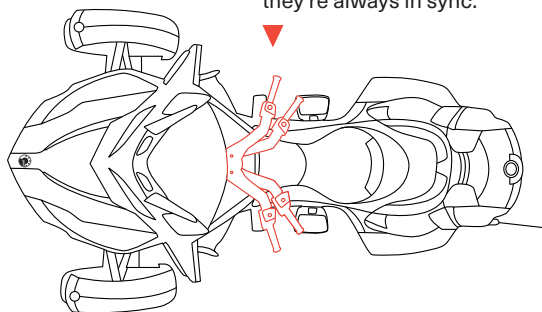

IDLER PULLEY

RT IDLER PULLEY SERVICE KIT

- (Not illustrated)
- Enhances your comfort on the road by reducing vibrations generated by the belt.

Spyder RT 2014 to 2019
 219800419
\$35.99

SEATS & BACKRESTS

New COMFORT SEAT

- Extra padding in all the right places in addition to a memory foam layer gives us every reason to call it our Comfort Seat.
- Smartly styled, its elevated passenger seat gives anyone coming along for the ride a scenic way to enjoy the open road.

Spyder RT 2020 and up
 219400971
\$699.99



New HEATED COMFORT SEAT

- All the features of the much-loved Comfort Seat with integrated heating.
- Unit complete with individual dual-intensity driver and passenger controls for customized warmth when the weather's cool but the ride is still hot.

Spyder RT 2020 and up
 219400972
\$909.99



New HEATED DRIVER SEAT

- With an exterior identical in every way to our quality stock seat, our Heated Driver Seat comes with the added perk of integrated heating that's designed to keep you warm and comfortable when temperatures start to dip.
- Stock equipment on the RT Limited.

Spyder RT 2020 and up
 219401044
\$459.99



New HEATED PASSENGER SEAT

- Our Heated Passenger Seat takes comfort to a new level with integrated heating for absolute warmth on those days the call of the open road is stronger than the thought of riding it in the cold.
- Stock equipment on the RT Limited.

Spyder RT 2020 and up
 219401045
\$459.99



COMFORT SEAT

- Ultra comfortable with lumbar support.
- Roomier for driver, improves comfort during long rides.
- Driver backrest ready.
- Perfect for taller riders.

All Spyder RT models 2019 and prior
 219400457
\$569.99



Moving the driver's seat position back just two inches (50 mm) relaxes the knees and upper body.

HEATED COMFORT SEAT

- Heated comfort seat with ability to slide-in the driver backrest.
- The driver and passenger can choose their own heat intensity.
- Dual range Hi/Low heat setting.
- Activated through stock passenger and driver heated grip controls.

All Spyder RT models 2019 and prior
 219400398
\$829.99



ADJUSTABLE DRIVER BACKREST

- New tilt adjustment to suit your riding style.
- Folds forward for easy passenger seat access.

For Production Seats

- Unique patent pending plug-and-go design installs in seconds and works with all standard Spyder RT driver seats with no modifications.

Spyder RT 2014 - 2019, RT 2013 and prior with 2014 and up production seats

219400679

\$399.99

For Comfort Seats

- Unique plug-and-go design installs in seconds and works with Spyder RT driver Comfort Seats with no modification.

Fits with Comfort Seat (219400457)

Fits with Heated Comfort Seat (219400398)

219400689

\$459.99

**ADJUSTABLE DRIVER BACKREST SUPPORT UPGRADE KIT**

- Kit adds tilt adjustment to previous generation driver backrests (219400358, 219400479, 219400480, 219400481).

For Production Seats

219400682

- Kit adds tilt adjustment to previous generation driver backrests (219400478, 219400488, 219400489, 219400490).

For Comfort Seats

219400683

\$79.99

**New ADJUSTABLE DRIVER BACKREST**

- Offering comfort for long-distance or short hops, our tilt-adjustable Driver Backrest folds down and out of the way for easier vehicle access.
- Its slim profile design allows for extra passenger room behind.
- Plus, it's lockable, so it'll always be there when you need it.
- Fits Comfort Seat (219400971), Heated Comfort Seat (219400972) and Heated Driver Seat (219401044).

Spyder RT 2020 and up

219400957

\$334.99

**New LinQ PASSENGER BACKREST**

- Installable quickly and easily onto the LinQ Rack, the Passenger Backrest is an excellent way to let your 2-up partner enjoy the rush of the ride in absolute comfort.
- Fully compatible with the optional Passenger Armrests (219400958).
- The RT LinQ Rack (219400973) is required for installation.

Spyder RT 2020 and up

219400967

\$459.99

**New PASSENGER ARMRESTS**

- Local or long-distance, these horizontally and vertically adjustable Passenger Armrests assure optimal comfort for those keeping you company for the ride.
- A snap to install, they pivot outwards to allow easy vehicle access.
- Incompatible with RT Rear Panel.

Spyder RT 2020 and up

219400958

\$429.99

**PASSENGER ARMRESTS**

- The ultimate in long- or short-distance passenger comfort.
- Pivot up and out of the way for easy passenger access and exit.
- Styled to ensure an absolute match to your Can-Am Spyder.
- Allow easy access to passenger handles for added safety.

All Spyder RT models 2019 and prior

219400839

\$364.99

**WINDSHIELDS & WIND PROTECTION****New ADJUSTABLE TOURING VENTED WINDSHIELD**

- Perfect for taller riders but designed for anyone who enjoys riding with less wind and more fun!
- Robust 4.5 mm thick scratch-resistant crystal-clear polycarbonate stands 3 full inches higher than our stock windshield, pushing the wind vortex up and over riders' heads creating considerably less buffeting for an appreciably quieter ride.
- Convenient integrated front vents offer variable air flow control.
- Tinted with 75% light transmission.
- Dimensions: 27 inches (68 cm) high.

Spyder RT 2020 and up

219400993

\$409.99

**New ADJUSTABLE SPORT WINDSHIELD**

- Give your Can-Am Spyder a look that lets everyone know you mean business!
- Our low-profile, road-rugged polycarbonate-build sport windshield is as ready for the road as it is for excitement.
- Sporty look, sporty feel, unforgettable ride.
- Tinted with 75% light transmission.
- Dimensions: 14 inches (35 cm) high.

Spyder RT 2020 and up

219400956

\$254.99



ADJUSTABLE VENTED WINDSHIELD

- Regulates driver frontal air flow.
- Integrated adjustable vent offers easy infinite management of horizontal slats from closed to fully opened.

All Spyder RT models 2019 and prior

25" (64 cm)

■ 219400435 · Clear with chrome

\$409.99

23" (58 cm)

■ 219400360 · Clear with chrome

\$364.99

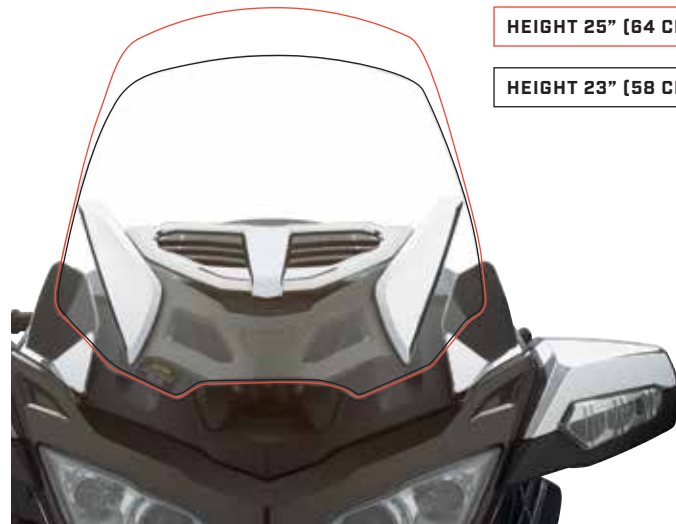

HEIGHT 25" [64 CM]

HEIGHT 23" [58 CM]

TOURING WINDSHIELD

- Lower and narrower design for riders looking for less wind protection than that provided by the stock Spyder RT model.

All Spyder RT models 2019 and prior

25" (64 cm)

219800199

\$329.99

23" (58 cm)

219400243

\$264.99



HEIGHT 25" [64 CM]

HEIGHT 23" [58 CM]

ADJUSTABLE SIDE WIND DEFLECTORS

- Regulate passenger and driver air flow.
- 3 preset positions (closed, parallel and inverted).
- Easy tool-less click adjustment.

All Spyder RT models 2019 and prior

□ 219400362 · Clear

\$154.99

All Spyder RT models 2019 and prior

■ 219400413 · Chrome

\$194.99

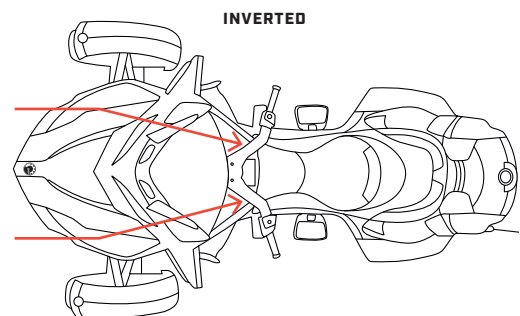
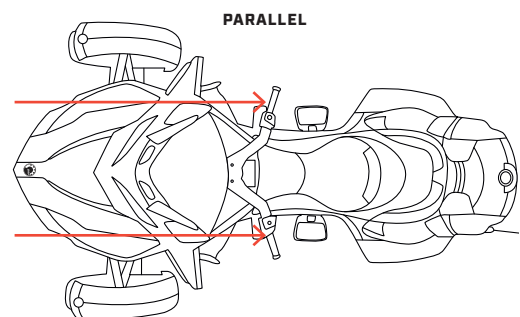
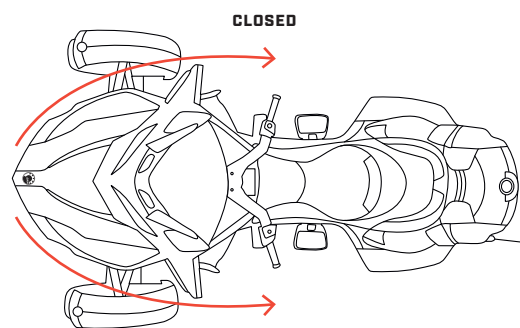
**3 ADJUSTABLE SIDE WIND DEFLECTOR PRESET POSITIONS****CARGO & STORAGE****New LinQ THERMAL BOX**

- Versatile, road-friendly, rotomolded-build LinQ Thermal Box designed to keep things hot or cold, and always ready for when you need them.
- Its expansive 4.2 Gal (16 L) capacity lets you cater to any size hunger or thirst for whatever the length of the ride.
- The RT LinQ Rack (219400973) is required for installation.

Spyder RT 2020 and up.

219400964

\$304.99

**New LinQ SPORT BAG**

- Our 4.5 Gal (17 L) LinQ Sport Bag holds everything in while keeping the weather out!
- The perfect place to keep wallets, water bottles, smartphones and jackets safe and secure.
- Constructed with a sturdy rigid bottom with semi-rigid top.
- RT LinQ Rack (219400973) required for installation.

Spyder RT 2020 and up.

860201678

\$174.99

**New LinQ SR21 TUNNEL BAG**

- Semi-rigid expandable LinQ Tunnel Bag offers a roomy 5.5 Gal (21 L) capacity with convenient quick and easy tool-less LinQ installation and removal.
- RT LinQ Rack (219400973) required for installation.

Spyder RT 2020 and up.

860201740

\$189.99

**New LinQ DRY BAG**

- LinQ Dry Bag offers 10.6 Gal (40 L) of fully-waterproof adjustable storage for your essentials.
- Its roll-top design secures your gear snugly, while a heavy-duty rigid plastic base and foam-lined bottom offer additional protection for the long haul.
- An integrated handle allows for easy transportation on or off the vehicle.
- Includes 2 LinQ Cargo bases.
- RT LinQ Rack (219400973) required for installation.

Spyder RT 2020 and up.

715002875

\$189.99

**New RT LinQ RACK**

- Enhance your Can-Am Spyder RT's flexibility with the convenient, incomparable RT LinQ Rack.
- Using a secured latch to hold a wide range of BRP LinQ 16" accessories, it's the ideal accessory multitasker!
- Installs in minutes without tools.
- Replaces the stock Top Case on RT Limited models.

Spyder RT 2020 and up.

219400973

\$299.99

**New LinQ TOOL HOLDERS**

- Our Tool Holders help score another point for LinQ's modular flexibility!
- Innovative swivel latch allows it to securely grip objects such as tools or fishing rods in a variety of positions!
- Sold in pairs.
- The RT LinQ Rack (219400973) is required for installation.

Spyder RT 2020 and up.

715003059

\$49.99

**New RT REAR PANEL**

- The Top Rear Panel caps the area normally occupied by the Top Case when not in use, preserving the smooth lines and sporty appearance of your ride.
- Incompatible with Passenger Armrests (219400958).
- Stock equipment on the Base model.

Spyder RT Limited 2020 and up.

■ 219401076 · Asphalt Grey

■ 219401012 · Chalk Metallic

■ 219401014 · Deep Marsala

■ 219401013 · Petrol Metallic

\$224.99



AVAILABLE IN FEBRUARY ONLY

New RT TOP CASE

- Consider the convenience of 46.7 Gal (177 L) when it comes to carrying all your essentials on that unforgettable road trip.
- Our all-new Top Case adds 5.8 Gal (22 L) of extra storage, but more than that, it expands practicality with a larger opening and it now fits 2 helmets!
- Plus it includes a dedicated USB port for device charging.
- Stock equipment on the RT Limited.

Spyder RT 2020 and up.

219401011

219401079 · Europe

\$1,999.99



AVAILABLE IN FEBRUARY ONLY

SEMI-RIGID REAR SIDE CARGO TRAVEL BAGS

- Stylish premium travel bags specifically sized to fit in rear side cargo.
- Retractable handle and shoulder straps for carrying convenience.
- Integrated pull tabs for effortless removal from cargo cavity.
- Sold in pairs.

All Spyder RT models

219400169

\$244.99

**TOP CASE INNER BAG**

- Maximizes top case volume.
- Complete with integrated handle and shoulder strap for convenient portability.

Spyder F3-T with Top Case, F3 Limited 2017 and up, RT 2020 and up

219400748

\$129.99

**SOFT SIDE CARGO TRAVEL BAGS**

- Soft travel bags that maximize Spyder RT rear side cargo space.
- Integrated handle for carrying convenience.
- Sold in pairs.

All Spyder RT models

219400172

\$59.99

**SEMI-RIGID REAR TOP CARGO TRAVEL BAG**

- Stylish premium travel bag specifically sized to fit in rear top cargo.
- Retractable handle for carrying convenience.
- Integrated pull tabs for effortless removal from cargo cavity.

All Spyder RT models 2019 and prior

219400168

\$109.99

**INTEGRATED HELMET BAG**

- Truly integrated easy-to-use helmet storage solution.
- Sturdy water-resistant construction.
- Includes elastic straps for tying down helmet bag onto seat.
- Complete with anti-theft wire for added security.

All Spyder RT models 2019 and prior and all Spyder F3 models

219400850

\$59.99

**FRONT CARGO LINER**

- Felt insert provides finishing touch to front compartment.
- Features multiple storage pockets.
- Stock equipment on the Spyder RT Limited 2020.

Spyder RT 2013-2019

219400368

All Spyder RT models 2020 and up

219401047

\$134.99

**TOP CASE MIRROR**

- For rear top cargo cover.
- Folds open, locks up when not in use.
- Offers a small cargo in the top case lid.

All Spyder RT models 2019 and prior

219400321

\$64.99

**SEMI-RIGID FRONT CARGO TRAVEL BAG**

- Rolling travel bag designed to maximize available front cargo space.
- Can also double as airplane carry-on luggage.

All Spyder RT models

219400167

\$214.99

**REAR TOP CARGO SHELF**

- For supporting and organizing rear top cargo.
- Two recessed compartments to support electronic accessories.
- Can be tilted to facilitate access to lower section of cargo.

All Spyder RT models 2019 and prior

219400232

\$54.99

**LIGHTS & ELECTRICAL ACCESSORIES****New FRONT SIGNATURE LIGHT**

- First impressions count, so adding our Front Signature Light ensures that no matter whether you're coming or going, no one will forget you were there.
- Stock equipment on the Limited edition model.
- Not EC compliant.

Spyder RT 2020 and up

219401024

\$179.99



AVAILABLE IN FEBRUARY ONLY

New AUXILIARY LIGHT

- Our LED Auxiliary Light helps redefine the night riding experience.
- Enhances confidence with improved low and wide visibility of the road ahead.
- Installs in minutes!
- Not EC compliant.

Spyder RT 2020 and up

219400991

\$254.99

**FOG LIGHTS**

- (Not illustrated)
- Enhance low beam light for better visibility at ground level and on sides.
- Uniquely styled halogen fog lamps feature a 35W bulb and clear lens with a faceted inner reflector.
- Easy installation.
- Not EC compliant.

All Spyder RT models 2019 and prior

219400579

\$539.99

GARMIN' ZUMO' 590 GPS

- Features a glove-friendly and sunlight-readable 5" (12.7 cm) dual-orientation touchscreen display.
- Offers hands-free phone control and spoken directions heard in-helmet via Bluetooth® 5 technology.
- Includes an MP3 player.
- iPod® and Pandora® compatibility.
- GPS Support (219400615) sold separately.
- Allows control of music right on the display.
- Rugged and tough enough to withstand fuel spills, UV rays and harsh weather.
- Offers access to real-time weather and traffic information via the smartphone link app.
- Free lifetime map updates.
- Curvy Roads Routing allows rider to find winding roads.
- Incompatible with 2018 RT and F3 models featuring the VIP cluster.

All Spyder models

219400512

219400699 · Europe

\$799.99



Zumo 590 GPS has the ability to link itself wirelessly to optional Garmin tire pressure sensors and the Garmin Virb video camera for enhanced GPS functionality.

New GPS SUPPORT

- Positions Garmin Zumo GPS on the center of all UFit handlebars.
- Wiring/charging harness included.
- Incompatible with the Roadthunder Soundbar by MTX (219400840).

Spyder RT 2020 and up

219400992

\$254.99

**ADJUSTABLE GPS MOUNTING KIT (FOR STOCK HANDLEBAR)**

(Not illustrated)

- Mounting kit for Garmin Zumo 590 GPS (219400512, 219400699 EC) with adjustable support that fits stock handlebar.
- Includes casting, electric harness, rubber boot and hardware.
- The support conveniently swivels to offer the right position for all riders or light conditions.
- GPS sold separately.

All Spyder RT 2019 and prior, ST, RS 2013 and up

219400615

\$234.99

GPS SUPPORT FOR TRI AXIS ADJUSTABLE HANDLEBAR (WITHOUT HARNESS)

(Not illustrated)

All Spyder RT models 2019 and prior

219800382

\$59.99

CGX3 CAMERA

- 160° wide angle lens.
- Resolution options: From 3MP up to 20MP and VGA.
- Video resolutions available: 2.7K at 30 frames per second (FPS), 720P at 120/60/30 FPS, 1080P at 60/30 FPS and VGA at 240 FPS.
- Record videos in 4K UHD at 24 FPS, 2.7K QHD at 30 FPS and 720P at 120 FPS.
- Memory: Class 10 32GB micro SD card.
- 5 cm (2") capacitive touchscreen.

9700130090

\$349.99

- Waterproof up to 10 m (32.8') without a case.
- Li-ion battery capacity of 1050mAh, working time of 1/1.5 hours and charging time of 3 hours (2 batteries included).
- WiFi function remotely operates up to 15 m (49.2') with mobile devices and CYCLOPS app for Android and IOS.
- Features modes such as invert, time lapse, high speed and loop recording, motion detection, capture (while recording a video), burst and anti-sharing.
- Comes with 8 mounting accessories.



SATELLITE RADIO KIT

- Receiver helps maintain radio reception everywhere.
- 150+ digital channels to choose from.
- 15 station presets for quickly tuning into your favorite programming.
- Plug-and-play system controlled via vehicle's cluster.
- Fee-based monthly subscription required.
- Entertainment Harness (219400610) required for installation.
- AM/FM Integrated Audio System (219400464) is also required for Spyder RT 2012 and prior.
- Headset sold separately.

**Spyder RT 2010-2017**

219400612

\$489.99**CB & COMMUNICATION SYSTEM**

- For staying in touch with friends across a range of 40 channels.
- Handlebar controls allow push-to-talk and adjust squelch levels for maximum performance and reception quality.
- Fully integrated system also mutes radio while in transmitting and receiving modes.
- Plug-and-play system controlled via vehicle's cluster.
- Works in conjunction with wired Communication Headset (4474380090).
- Entertainment Harness (219400610) required for installation.
- AM/FM Integrated Audio System (219400464) also required for Spyder RT 2012 and prior models.

**Spyder RT 2010-2017**

219400611

\$849.99**COMMUNICATION HEADSET (WIRED)**

- For rider and passenger.
- Includes headset and microphone.
- Works in conjunction with the CB and Communication System (219400611).
- Available as an option on the Can-Am Spyder RT models.

**Spyder RT 2010-2017**

4474380090

\$189.99**PUSH-TO-TALK REMOTE FOR PASSENGER**

- Passenger communication system (wired) for use with wired headsets and microphones (4474380090).
- Provides passenger with vehicle-to-vehicle communication capabilities with push-to-talk (PTT) button.
- Works in conjunction with the CB & Communication System (219400611).
- Available as an option on the Can-Am Spyder RT models.

**Spyder RT 2010-2017**

4474760090

\$79.99**ENTERTAINMENT HARNESS**

- (Not illustrated)
- Required to install the CB and Communication System (219400611) and Satellite Radio Kit (219400612).

Spyder RT 2010-2017

219400610

\$129.99**CB ANTENNA REPLACEMENT KIT**

- (Not illustrated)
- Includes antenna, antenna base, ground strap and wires.

All Spyder RT models 2010-2017 (Service kit)

219400317

\$159.99**POWER OUTLET KIT**

- Recharges your electronic devices while riding* (smartphone, MP3, heating gear, etc.).
- Dual port USB connectors.
- Plug-and-play kit.
- Simply connect under driver seat and use.

*The power outlet is not capable of recharging all device types while riding.



- Adds an extra 12V power outlet to your vehicle.
- Conveniently located in front cargo bin.

All Spyder RT models 2019 and prior, RS, ST, F3, F3-S

219400510 · USB

\$31.99**All Spyder models**

219400366 · 12V

\$35.99**IPOD INTEGRATION CABLE**

- Cable for hooking up an iPod (30 pin connector common to Apple devices) to top cargo's DIN connector.
- Includes 5V transformer.
- Full-feature handlebar control.
- Dot-Matrix visual interface.
- Driver volume control and playlist browser convenience through vehicle's cluster.
- An adapter may be required for latest-generation iPod or iPhone.
- Standard on Spyder RT and ST Limited packages.
- Located in the front compartment on Spyder ST and in rear compartment on Spyder RT.
- Check compatibility with your dealer.

**Spyder RT 2014 - 2019, ST**

710002676

\$74.99**BLUETOOTH DONGLE FOR AUDIO SYSTEM**

- Allows a wireless Bluetooth connection between the vehicle's AM/FM radio (or any non-Bluetooth audio device) and the Bluetooth Communication System.
- Dual streaming to 2 Bluetooth headsets at the same time.
- Headset and AM/FM radio sold separately.

All Spyder RT models 2018 and prior, ST 2010-2017

219400458

\$264.99**3.5 MM AUDIO PLAYER INPUT**

- 3.5 mm cable for hooking up an MP3 player to top cargo's DIN connector.
- Driver volume control convenience through vehicle's cluster.

Spyder RT 2014-2019, ST

710001406

\$38.99**WHEELS****15" FAT 6 CHROME WHEELS**

- Same design as Spyder F3 production wheels in PVD finish.
- Sold in pairs.

All Spyder F3 and RT models, RS, ST 2013 and up

■ 219400589 · Chrome

\$729.99**15" BONNEVILLE DISH WHEELS**

- Give your Can-Am Spyder a retro look with these 15" wheels inspired by Salt Flat racers.
- Wheel nuts are hidden behind the center cap.
- Sold in pairs.

All Spyder F3 and RT models, RS, ST 2013 and up

■ 219400501 · Black

\$609.99**15" BLADE MAG WHEELS**

- Unidirectional design (left and right wheel).
- Patented casting process allows a weight reduction of 2.2 lbs (1 kg) per wheel compared to stock wheels.
- Sold in pairs.

All Spyder F3 and RT models, RS, ST 2013 and up

■ 219400465 · Black

\$669.99**15" SHAMROCK WHEELS**

- Add personality to your Can-Am Spyder.
- Casted, painted and machined wheels.
- Sold in pairs.

All Spyder F3 and RT models, RS, ST 2013 and up

■ 219400500 · Deep Black

\$624.99**CHROME REAR WHEEL**

- 6-spoke PVD (chrome-like powder coat more resistant than regular chrome) monobloc rear wheel (hub and wheel in one piece).

All Spyder F3 and RT models, RS, ST 2013 and up

■ 219400574 · Chrome

\$669.99**15" BLADE MAG WHEELS SERVICE KIT**

- (Not illustrated)
- Replacement "blade" for wheels.

■ 219400542 · Left · Brushed Aluminum

■ 219400543 · Right · Brushed Aluminum

\$24.99**FENDERS****LOW BROW FRONT FENDERS**

- Super sleek drawn steel fenders with LED position lights integrated into the front edge.
- Include electrical harness and required hardware.
- Sold in pairs.
- LED position lights not EC compliant.

Spyder RT models 2019 and prior, RS, ST 2013 and up, all Spyder F3 models 2018 and prior

■ 219400502 · Carbon Black

\$959.99**FRONT FENDER SUPPORTS**

- Supports for Front Fenders, including position lights, reflectors and hardware.
- Front Fenders sold separately.
- Sold in pairs.

All Spyder F3, RS, ST and RT models 2019 and prior

219400359

\$409.99

CUSTOM ACCESSORIES



HANDLEBAR END CAPS

· Sold in pairs.

All Spyder models

■ 219400702 · Chrome

\$41.99



SIDE CAN-AM TRIMS

· Sold in pairs.

All Spyder RT models 2018 and prior

■ 219400195 · Chrome

\$84.99



WINDSHIELD TRIM

All Spyder RT models 2018 and prior

■ 219400191 · Chrome

\$64.99



EXHAUST TIP AND HEAT SHIELD

· Kit for custom finishing your stock exhaust system.
· Includes chrome end pipe, heat shield and hardware.

All Spyder RT models 2018 and prior, RS, ST, F3-T, F3 Limited

■ 219400473 · Chrome

\$309.99



REAR TOP CARGO TRIM

All Spyder RT models 2018 and prior

■ 219400192 · Chrome

\$84.99



SHOCKS

FOX ADJUSTABLE FRONT SHOCK KIT

· Velocity sensitive, bolt-on suspension upgrade specially tuned for Spyder RT.
· Includes stiffer springs and adjustable preload to adapt to your riding style and reduce body roll.
· Fully serviceable and rebuildable.
· Part of the Podium Performance Series, delivers great performance and comfort.

All Spyder RT models 2019 and prior

219400588

\$509.99



SILENCERS

AKRAPOVIČ SILENCERS TOP FEATURES

- Innovative design. First hexagonal shaped silencers.
- The best materials. Premium titanium shell construction with carbon fiber end cap and heat shield render these silencers 55% lighter than the stock silencer.
- The unmistakable sound of Akrapovič. Deep resonant sound that you won't hear anywhere else.
- EPA, CARB and EC certified. Rigorous measurement, testing and quality control ensure silencers meet the most stringent standards.
- Exhaust fit compatible with all BRP genuine accessories.

AKRAPOVIČ SPORT TOURING 3C SILENCER

· Set your ride apart with the dynamic, deep resonant sound of an Akrapovič silencer.
· Its premium titanium and carbon fiber construction is 55% lighter than the stock model and it's been tested to meet the most stringent requirements.
· Not AS certified.

Spyder F3-T, F3 Limited, RT 2015 and up

■ 219400650 · Titanium · Canada / US

■ 219400838 · Titanium · Other countries

\$999.99



COVERS

CUSTOM VEHICLE COVER

· Made of tough water-repellent, breathable 300-denier polyester.
· This cover provides maximum vehicle protection while trailering or outdoor storing.
· Includes integrated exhaust panel and protective flannel windshield liner.
· Easy attach system secures cover in all trailering conditions.
· Compatible with RT Passenger Armrests (219400839).

All Spyder RT models 2019 and prior

■ 219400860 · Black

\$254.99



TRAVEL COVER

· Provides protection to vehicle's top areas (windshield, seat, top cargo).
· Stows conveniently into top cargo and takes up little space.
· Quick installation and removal.

All Spyder RT models 2019 and prior

■ 219400199 · Black

\$114.99



New RT OUTDOOR COVER

· Protect the ride you love from the elements you want to avoid.
· This weatherproof, 100-denier cover is lined with no-scratch flannel for optimal windshield protection, so everything looks as good when the cover comes off as when it went on.
· Fits both the Standard and Limited edition models and accommodates all Can-Am accessories!

Spyder RT 2020 and up

219400968

\$179.99



New RT TRAILERING COVER

· Our 300-denier weatherproof Trailering Cover is the best way to keep things clean and dry.
· Complete with no-scratch-flannel liner, convenient heat-resistant panel for exhaust protection, and all trailering attachments.
· Fits both the Standard and Limited edition models and accommodates all Can-Am accessories!

Spyder RT 2020 and up

219400970

\$259.99



New RT TRAVEL COVER

· Keep your favorite ride safe from the elements anywhere you stop while on the road.
· This 100-denier half-cover protects our optional Top Case (219401011) and comes complete with an integrated pocket for convenient storage when not in use.
· Accommodates all Can-Am accessories!

Spyder RT 2020 and up

219400969

\$114.99



CAN-AM FREEDOM TRAILER



PUT LONG DISTANCE WORRIES BEHIND YOU.

Advanced technology, design and bold styling come together to deliver an exceptional trailering experience – so you can head out with everything you need for as long as you want.

CAN-AM FREEDOM TRAILER FEATURES

- Independent suspension with coil-over shocks and low trailer floor provide a stable, smooth ride.
- Can-Am Spyder RT, ST, F3-T and F3 Limited Vehicle Stability System adapts to the trailer.
- Hinged lid opens wide for easy loading.
- Lid opens with one hand and stays open with air-spring assist.
- Interior's flat bottom and optimized shape maximize capacity. Capacity: 566 L / 20 ft³.
- Easily holds enough for two travelers, or two golf bags.
- The only trailer that maintains vehicle factory warranty.

CAN-AM FREEDOM TRAILER

All Spyder RT models, ST, F3-T, F3 Limited
 ■ 000T1KA00 · Black
\$3,424.99



TRAILER HITCH KIT AND CONTROL MODULE

- Heavy-duty trailer hitch specifically designed for use in conjunction with Can-Am Freedom Trailer.
- Patent pending impact-absorbing mechanical design ensures maximum trailer and vehicle performance.
- Meets all stringent vehicle safety requirements.
- Integrated mud flap reduces damage from rock chips and other debris.
- Wiring components and full-function light control module included.
- Installs and removes easily.
- Only system on the market that maintains vehicle warranty requirements.

Spyder F3-T, F3 Limited 2018 and up
 219400852
\$669.99
Spyder RT 2018-2019
 219400854
\$669.99
Spyder RT 2020 and up
 219400990 **New**
\$669.99



TRAILER STORAGE COVER

- 100% polyester with integrated storage pocket.
- Product may differ from picture shown.

Can-Am Freedom Trailer
 ■ 219400592 · Black
\$149.99



CONTROL MODULE HARNESS SERVICE KITS

(Not illustrated)

- Allows installation of the Trailer Hitch and the Trailer Hitch and Control Module.

Spyder F3-T, F3 Limited, RT 2018
 219400853
\$39.99

- Allows installation of the Trailer Hitch Kit and Control Module (219400854).

Spyder RT 2010 - 2017
 219400893
\$39.99

- Allows installation of the Trailer Hitch (219400852).

Spyder F3-T, F3 Limited 2016-2017
 219400855
\$39.99

TRAILER TONGUE STAND

(Not illustrated)

- Keeps trailer leveled when not hitched to vehicle.

Can-Am Freedom, RT-622 Trailers
 219400190
\$99.99

4-PIN TRAILER ADAPTOR HARNESS

- Designed to convert the trailer's electrical harness into a standard 4-pin trailer connector for automotive use.

Can-Am Freedom, RT-622 2013-2014 Trailers
 219400437
\$79.99



PREMIUM CARPET

- Crafted from virtually indestructible thermoplastic.
- Computer-cut for a precision fit in your vehicle.

Can-Am Freedom Trailer
 219400538
\$264.99



SPARE WHEEL TIRE BAG

- Spare tire transportation bag with integrated clipping system to secure tire in trailer.

Can-Am Freedom, RT-622 Trailers
 219400307
\$59.99



CAN-AM FREEDOM TRAILER STRIPE DECAL KIT

- Premium stripe decals add a sporty look to match the Freedom Trailer to your Can-Am Spyder.

Can-Am Freedom Trailer
 ■ 219400669 · Can-Am Red
 □ 219400671 · Gloss White
 ■ 219400675 · Matte Black
 ■ 219400676 · Pure Magnesium
 ■ 219400677 · Satin Silver
 □ 219400678 · Vegas White Pearl
 ■ 219400693 · Orbital Blue
\$254.99



RIDING GEAR

Hit the road in style.

Look beyond the horizon, to all of those unseen, unexplored destinations that never seem to stop calling you. Listen to your heart and head out... anywhere. In fact, the farther the better. Don't just live your dreams, ride them – intensely, completely, and without hesitation. Anywhere you're headed is home when you're riding the Can-Am On-Road experience.



JACKET TECHNOLOGY

Use this guide to find the features you want by looking for the corresponding symbol within our extensive collection of jackets.

100% Waterproof
To keep you dry in all conditions.

Windproof
To protect from air infiltration.

Water-resistant
To keep you dry in light rain conditions or during short rides.

Adjusted fit
Fits closer to the body.

Relaxed fit
Looser fit for relaxed riding position.

Removable insulated lining
To adapt to the current temperature. Wear when cold, remove when warm.

RPM
Critical seams and logos are sealed, so water can't enter through potential openings.

RPM MAX
100% of seams and logos are sealed, so water can't enter through potential openings.

Pockets for removable protectors
Pouches to insert removable protectors (sold separately).



High performance gear with RPM technology

RPM & RPM MAX coatings keep wind and water out and still allow perspiration to escape.

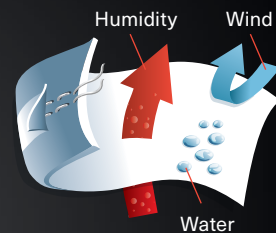

MEN'S

Learn all about the features and technologies of our Men's gear.
Go to: canamonroad.com/videos



LEATHER JACKET

RYKER COLLECTION

CAN-AM LEATHER JACKET

- Features:**
- Premium-quality leather.
 - YKK® zipper opening.
 - Fully-removable shoulder, elbow and spine protectors.
 - Waist adjustment system and built-in belt loops at waist.
 - Pattern-perforated underarm panels and microfiber-lined cuffs add extra comfort.
 - Reflective safety trim.

- Benefits:**
- Designed for extra comfort, fit and flexibility over long and short distance.
 - Stylish leather in a contemporary cut.
 - Engineered for practicality and tailored for durability.

Shell: 100% Leather
440828 · S, M, L, XL, 2XL, 3XL
Black (90)
\$399.99



TEXTILE JACKETS

RYKER COLLECTION

CAN-AM TEXTILE JACKET

- Features:**
- Water-resistant outer shell.
 - Fully-removable shoulder, elbow and spine protectors.
 - Waist adjustment system and built-in belt loops at waist.
 - Removable cotton/poly hooded sleeveless liner.
 - Ventilation control.
 - Microfiber-lined collar and cuffs add extra comfort.
 - Reflective safety trim.

Shell: 80% Polyester, 15% Fleece, 5% Other
440829 · S, M, L, XL, 2XL, 3XL · Black (90)
\$229.99



- Benefits:**
- Designed for extra comfort, fit and flexibility over long and short distance.
 - Stylish, contemporary cut.
 - Engineered for practicality, tailored for durability.



RYKER COLLECTION

CAN-AM KEVLAR® DENIM SHIRT

Features:

- Cotton/poly blend.
- Concealed YKK main zipper.
- Built-in belt loops at waist.
- Dupont® Kevlar reinforced shoulders and elbows.
- Convenient shoulder-expansion gussets.
- Snap-down collar.

Benefits:

- Practical, comfortable and perfect for any ride.

Shell: 100% Cotton

440838 · S, M, L, XL, 2XL, 3XL · Black (90)

\$134.99



CALIBER JACKET

Features:

- Teflon®-treated highly water- and wind-resistant fabric.
- Extensive chest-area ventilation.
- Cushioned collar edge prevents chafing.
- Shaped sleeves.
- Multi-adjustable biceps, forearms, wrists, and waist.
- Reflective safety trim.

Benefits:

- Superior comfort in almost any weather condition.
- High breathability ensures dryness.
- Highly durable for extended wear and long-distance rides.
- Easily adjustable for optimum mobility.
- Enhanced low-light and nighttime visibility for added safety.

Shell: 100% Nylon

Insulation: 100% Polyester

440822 · S, M, L, XL, 2XL, 3XL · Red (30), Black (90)

\$279.99



PLUS SIZE

VOYAGER JACKET

Features:

- Teflon®-treated highly water- and wind-resistant fabric.
- Chest-area ventilation.
- Cushioned collar edge prevents chafing.
- Shaped sleeves.
- Multi-adjustable biceps, wrists and waist.
- Adjustable back-waist level.
- Reflective safety trim at front and back.

Benefits:

- Excellent comfort and protection in many weather conditions.
- High breathability ensures dryness.
- Easily adjustable for optimum mobility.
- Extended-wear durability.
- Low-light and nighttime visibility for added safety.

Shell: 100% Nylon

Insulation: 100% Polyester

440824 · L PLUS, XL PLUS, 2XL PLUS, 3XL PLUS, 4XL PLUS · Black (90)

\$349.99



MESH JACKETS

RUSSELL MESH JACKET

Features:

- Made of highly breathable mesh fabric with removable lightweight insulation.
- Shaped sleeves.
- Adjustable waist, biceps, forearms and sleeves openings.
- Reflective details at back.

Benefits:

- Lightweight comfort with outstanding breathability.
- Excellent flexibility and rider fit.
- Convenience, practicality and nighttime visibility.

Shell: 60% Polyester, 40% Nylon

Insulation: 100% Polyester

440676 · S, M, L, XL, 2XL, 3XL · Black (90)

\$199.99



PLUS SIZE

SHAUN MESH JACKET

Features:

- Made of highly breathable mesh.
- Shaped sleeves.
- Adjustable waist, biceps and sleeves openings.
- Reflective details at back.

Benefits:

- Outstanding breathability and extra roominess for comfort.
- Excellent flexibility and rider fit.
- Convenience, practicality and nighttime visibility.

Shell: 58% Polyester, 42% Nylon

Insulation: 100% Polyester

440738 · L PLUS, XL PLUS, 2XL PLUS, 3XL PLUS, 4XL PLUS, 5XL PLUS · Black (90)

\$249.99



TECHNICAL WEAR

WINDPROOF FLEECE

- Windproof, water-resistant soft shell.
- Brushed fabric interior for exceptional comfort.
- Lycra inner wrist with lengthened riding cuff.
- Reflective details for added visibility.

96% Polyester, 4% Spandex

454130 · S, M, L, XL, 2XL, 3XL · Black (90)

\$129.99



WINDPROOF PANTS

- Windproof, water-resistant soft shell.
- Brushed fabric interior for exceptional comfort.
- Ergonomic high-back design with shaped knees.
- Accommodate belts.
- 2 back, 2 hip and 1 zippered thigh pocket offer practicality and convenience.

96% Polyester, 4% Spandex

441637 · 30, 32, 34, 36, 38, 40, 42, 44 · Black (90)

\$99.99

PLUS SIZE

- Plus-sized tailored for a more flattering, comfortable fit.

441641 · 46, 48 · Black (90)

\$109.99



RYKER COLLECTION

CAN-AM MESH JACKET

Features:

- Made of highly breathable mesh fabric with removable lightweight insulation.
- Shaped sleeves.
- Adjustable waist, biceps, forearms and sleeves openings.
- Reflective details at back.

Benefits:

- Lightweight comfort with outstanding breathability.
- Excellent flexibility and rider fit.
- Convenience and practicality.

Shell: 60% Polyester, 40% Nylon

Insulation: 100% Polyester

440842 · S, M, L, XL, 2XL, 3XL · Black (90)

\$199.99



RAIN GEAR

RYKER COLLECTION

RAIN JACKET

- Waterproof, windproof and UV-resistant Teflon[®]-treated nylon PVC fabric.
- All critical seams fully sealed.
- Dual-hood system includes innovative under-helmet liner hood for use in heavy rain.
- Back ventilation.
- Shaped sleeves, adjustable collar, hem and wrists deliver fit and flexibility.
- Conveniently packs up into rear-collar pocket.
- Reflective safety trim at front and back.

Shell: Waterproof Nylon

440840 · XS, S, M, L, XL, 2XL, 3XL · Black (90)

\$109.99



RYKER COLLECTION

RAIN PANTS

- Lightweight waterproof and windproof Teflon[®]-treated Nylon PVC fabric.
- All critical seams fully sealed.
- Large Velcro[®]-hemmed side-leg gusset lets you slip on pants while wearing boots.
- Reflective safety details on left leg.

Shell: Waterproof Nylon

440841 · XS, S, M, L, XL, 2XL, 3XL · Black (90)

\$59.99



RAIN JACKET

- Waterproof, windproof and UV-resistant Teflon[®]-treated nylon PVC fabric.
- All critical seams fully sealed.
- Dual-hood system includes innovative under-helmet liner hood for use in heavy rain.
- Back ventilation.
- Shaped sleeves, adjustable collar, hem, and wrists deliver fit and flexibility.
- Conveniently packs up into rear-collar pocket.
- Reflective safety trim at front and back.

Shell: Waterproof Nylon

440568 · XS, S, M, L, XL, 2XL, 3XL · Black (90)

\$109.99



RAIN PANTS

- Lightweight waterproof and windproof Teflon[®]-treated nylon PVC fabric.
- All critical seams fully sealed.
- Large Velcro[®]-hemmed side-leg gusset lets you slip on pants while wearing boots.
- Reflective safety details on left leg.

Shell: Waterproof Nylon

441501 · XS, S, M, L, XL, 2XL, 3XL · Black (90)

\$59.99



GLOVES

RYKER COLLECTION

CAN-AM LEATHER GLOVES

- Fine-grain leather.
- High-density hinged knuckle protector offers added protection.
- Leather-reinforced gel palm for extra comfort.
- Convenient hook and loop cuff fastener.

Shell: 100% Leather

446312 · S, M, L, XL, 2XL · Black (90)

\$74.99



RYKER COLLECTION

CAN-AM MESH GLOVES

- Lightweight air-mesh fabric build delivers exceptional comfort, ventilation and flexibility.
- Pre-curved design with short cuff for improved fit.
- Extra-durable Clarino[®] leather palm.
- Silicone fingertips offer enhanced grip.

Shell: 41% Polyester, 33% Clarino, 26% Lycra

446315 · S, M, L, XL, 2XL, 3XL · Black (90)

\$39.99



ALL WEATHER

BLAKE LEATHER GLOVES

- Fine-grade leather.
- Fit perfectly to offer warmth and protection for mild weather.
- Suede forefinger to wipe visor.
- Padded palm for comfort during longer rides.

Shell: Cow Leather

446290 · M, L, XL, 2XL, 3XL · Black (90)

\$54.99



HOT WEATHER

MECHANIC GLOVES

- Multizone padded palm reduces hand fatigue from shock and vibration.
- Pre-curved design for improved fit.
- Double Clarino[®] layer at palm and thumb for extra durability and increased comfort.

Shell: 55% Nylon, 23% Polyester, 18% Polyurethane, 4% Spandex

446267 · S, M, L, XL, 2XL · Black (90)

\$44.99



SPORTSWEAR



New RYKER ZIPPED HOODIE

60% Cotton
40% Polyester Fleece

454234

S, M, L, XL, 2XL, 3XL

Heather Grey (27), Navy (89)

\$79.99



New URBAN HOODIE

60% Cotton
40% Polyester Fleece

454236

S, M, L, XL, 2XL, 3XL

Black (90)

\$69.99



New LONG SLEEVE URBAN TEE

100% Cotton

454230

S, M, L, XL, 2XL, 3XL

Grey (09), Navy (89)

\$29.99



New LONG SLEEVE LOGO TEE

100% Cotton

454221

S, M, L, XL, 2XL, 3XL

White (01), Black (90)

\$34.99



TECHNICAL LONG SLEEVE TEE

· Stretchable technical fabric provides easy movement.

92% Polyester

8% Spandex

454145 · S, M, L, XL, 2XL, 3XL

Black (90)

\$59.99



BACK

New RIDE TEE

100% Cotton

454196

S, M, L, XL, 2XL, 3XL
Khaki (05), Wine (32),
Navy (89), Black (90)**\$24.99****New URBAN TEE**

100% Cotton

454226

S, M, L, XL, 2XL, 3XL
Khaki (05), Navy (89)**\$24.99**

BACK

New Y NATION TEE

100% Cotton

454223 · XS, S, M, L, XL, 2XL, 3XL

White (01), Navy (89)

\$24.99**New RYKER TEE**

100% Cotton

454228 · S, M, L, XL, 2XL, 3XL

Charcoal Grey (07), Wine (32)

\$24.99**CALIBER POLO**

· Moisture wicking polyester to keep you cool and dry.

88% Polyester, 12% Spandex

454141 · S, M, L, XL, 2XL, 3XL

Heather Grey (27), Black (90)

\$49.99**New CRUISE CAP**

· Plastic strap adjuster at back.

Shell: 100% Cotton

447710 · One size · Grey (09), Navy (89), Black (90)

\$24.99**New CLASSIC CAP**

· Adjustable back strap.

Shell: 100% Cotton

447727 · One size · Heather grey (09), Red (30), Black (90)

\$19.99**New CAMO CAP**· Comfortable cotton/
polyester blend.
· Plastic size-adjustment tab.Shell: 55% Cotton,
45% Polyester

447668 · One size

Khaki (05), Black (90)

\$24.99**CAN-AM BEANIE**

· Comfortable acrylic jersey knit.

Shell: 100% Acrylic

447689 · One size

Heather Grey (27), Black (90)

\$34.99

LADIES'

Learn all about the features and technologies of our Ladies' gear.
Go to: canamonroad.com/videos



TEXTILE JACKETS

RYKER COLLECTION**CAN-AM TEXTILE JACKET****Features:**

- Hybrid leather and water-resistant textile outer shell.
- Fully-removable shoulder, elbow and spine protectors.
- Waist adjustment system and built-in belt loops at waist.
- Removable cotton/poly hooded liner.
- Convenient shoulder-expansion gussets.
- Ventilation control.
- Microfiber-lined collar and cuffs for extra comfort.
- Leather accents.

Benefits:

- Comfortable and flattering fit.
- Stylish, contemporary design.
- Engineered for practicality, tailored for durability and high visibility.

Shell: 80% Polyester

15% Fleece, 5% Leather

440839 · S, M, L, XL, 2XL · Black (90)

\$229.99**CRUISE JACKET****Features:**

- Teflon-treated highly water- and wind-resistant fabric.
- Shaped sleeves.
- Chest and back ventilation.
- Multi-adjustable biceps, wrist and waist openings.
- Reflective safety trim at front and back.

Shell: 99% Nylon, 1% Polyester

Insulation: 100% Polyester

440734 · XS, S, M, L, XL, 2XL · White (01)

\$259.99**Benefits:**

- Outstanding ventilation, lightweight for extra comfort.
- Excellent flexibility and rider fit.
- Wind and water protection.
- Convenience, good practicality and nighttime visibility.



CALIBER JACKET

Features:

- Teflon[®]-treated highly wear-resistant fabric with all critical seams sealed.
- Cushioned collar edge prevents chafing.
- Shaped sleeves.
- Multi-adjustable biceps, forearms, wrists and waist.
- Reflective safety trim at front and back.

Benefits:

- Superior comfort in almost any weather condition.
- High breathability ensures dryness.
- Highly durable for extended wear and long-distance rides.
- Easily adjustable for optimum mobility.
- Enhanced low-light and nighttime visibility for added safety.

Shell: 100% Nylon

Insulation: 100% Polyester

440823 · XS, S, M, L, XL, 2XL, 3XL

Charcoal Grey (07), Black (90)

\$279.99



PLUS SIZE

VOYAGER JACKET

Features:

- Teflon[®]-treated highly water- and wind-resistant fabric.
- Chest-area ventilation.
- Cushioned collar edge prevents chafing.
- Shaped sleeves.
- Multi-adjustable biceps, wrists, and waist.
- Adjustable back-waist level.
- Reflective safety trim at front and back.

Benefits:

- Excellent comfort and protection in many weather conditions.
- High breathability ensures dryness.
- Easily adjustable for optimum mobility.
- Extended-wear durability.
- Low-light and nighttime visibility for added safety.

Shell: 100% Nylon

Insulation: 100% Polyester

440825 · L PLUS, XL PLUS, 2XL PLUS, 3XL PLUS, 4XL PLUS

Black (90)

\$349.99



MESH JACKETS

RYKER COLLECTION

CAN-AM MESH JACKET

Features:

- Ultra-breathable mesh fabric shell with removable lightweight insulation.
- Low collar for comfort and shaped sleeves for added mobility.
- Adjustable bicep, wrist and waist.
- Reflective safety trim at front and back.

Benefits:

- Breathable, flexible comfort ideal for fair weather rides.
- Easily adjustable for optimum mobility.
- Convenient, practical and durable.
- Easily adjusts for better flexibility and fit.

Shell: 63% Polyester, 37% Nylon

Insulation: 100% Polyester

440843 · XS, S, M, L, XL, 2XL · Black (90)

\$199.99



KATE MESH JACKET

Features:

- Ultra-breathable mesh fabric shell with removable lightweight insulation.
- Low collar for comfort and shaped sleeves for added mobility.
- Adjustable bicep, wrist and waist.
- Reflective safety trim at front and back.

Benefits:

- Breathable, flexible comfort ideal for fair weather rides.
- Easily adjustable for optimum mobility.
- Convenient, practical and durable.
- Easily adjusts for better flexibility and fit.

Shell: 63% Polyester, 37% Nylon

Insulation: 100% Polyester

440736 · XS, S, M, L, XL, 2XL · Black (90)

\$199.99



PLUS SIZE

EMMA PLUS MESH JACKET

Features:

- Ultra-breathable mesh fabric shell with removable lightweight insulation.
- Low collar for comfort and shaped sleeves for added mobility.
- Adjustable bicep, wrist and waist.
- Reflective safety trim at front and back.

Benefits:

- Breathable, flexible comfort ideal for fair weather rides.
- Easily adjustable for optimum mobility.
- Convenient, practical and durable.
- Easily adjusts for better flexibility and fit.

Shell: 56% Polyester, 44% Nylon

Insulation: 100% Polyester

440739 · M PLUS, L PLUS, XL PLUS, 2XL PLUS, 3XL PLUS · Black (90)

\$249.99



TECHNICAL WEAR

WINDPROOF FLEECE

- Windproof, water-resistant soft shell.
- Brushed fabric interior for exceptional comfort.
- Lycra inner wrist with lengthened riding cuff.
- Reflective details for added visibility.

Shell: 96% Polyester, 4% Spandex

454129 · XS, S, M, L, XL, 2XL

Black (90)

\$129.99



WINDPROOF PANTS

- Windproof, water-resistant soft shell.
- Brushed fabric interior for exceptional comfort.
- Ergonomic high-back design with shaped knees.
- Accommodate belts.
- 2 back, 2 hip and 1 zippered thigh pocket offer practicality and convenience.

Shell: 96% Polyester, 4% Spandex

441638 · 6, 8, 10, 12, 14, 16, 18 · Black (90)

\$99.99

PLUS SIZE

- Plus-sized tailored for a more flattering, comfortable fit.

441642 · 20, 22 · Black (90)

\$109.99



RAIN GEAR

RYKER COLLECTION

RAIN JACKET

- Waterproof, windproof and UV-resistant Teflon[®]-treated nylon PVC fabric.
- All critical seams fully sealed.
- Dual-hood system includes innovative under-helmet liner hood for use in heavy rain.
- Back ventilation.
- Shaped sleeves, adjustable collar, hem, and wrists deliver fit and flexibility.
- Conveniently packs up into rear-collar pocket.
- Reflective safety trim at front and back.

Shell: Waterproof Nylon

440840 · XS, S, M, L, XL, 2XL, 3XL

Black (90)

\$109.99



RYKER COLLECTION

RAIN PANTS

- Lightweight waterproof and windproof Teflon[®]-treated nylon PVC fabric.
- All critical seams fully sealed.
- Large Velcro-hemmed side-leg gusset lets you slip on pants while wearing boots.
- Reflective safety details on left leg.

Shell: Waterproof Nylon

440841 · XS, S, M, L, XL, 2XL, 3XL

Black (90)

\$59.99



RAIN JACKET

- Waterproof, windproof and UV-resistant Teflon[®]-treated nylon PVC fabric.
- All critical seams fully sealed.
- Dual-hood system includes innovative under-helmet liner hood for use in heavy rain.
- Back ventilation.
- Shaped sleeves, adjustable collar, hem, and wrists deliver fit and flexibility.
- Conveniently packs up into rear-collar pocket.
- Reflective safety trim at front and back.

Shell: Waterproof Nylon

440568 · XS, S, M, L, XL, 2XL, 3XL

Black (90)

\$109.99



RAIN PANTS

- Lightweight waterproof and windproof Teflon[®]-treated nylon PVC fabric.
- All critical seams fully sealed.
- Large Velcro-hemmed side-leg gusset lets you slip on pants while wearing boots.
- Reflective safety details on left leg.

Shell: Waterproof Nylon

441501 · XS, S, M, L, XL, 2XL, 3XL

Black (90)

\$59.99



GLOVES

RYKER COLLECTION

CAN-AM LEATHER GLOVES

- Fine-grain leather.
- High-density hinged knuckle protector offers added protection.
- Leather-reinforced gel palm for extra comfort.
- Convenient hook and loop cuff fastener.

Shell: 100% Leather

446314 · S, M, L, XL, 2XL · Black (90)

\$74.99



RYKER COLLECTION

CAN-AM MESH GLOVES

- Lightweight air-mesh fabric build delivers exceptional comfort, ventilation and flexibility.
- Pre-curved design with short cuff for improved fit.
- Extra-durable Clarino® leather palm.
- Silicone fingertips offer enhanced grip.

Shell: 49% Polyester, 27% Clarino Nash, 24% Elasthane

446316 · XS, S, M, L, XL, 2XL · Black (90)

\$39.99



VERONICA LEATHER GLOVES

- Fine-grade leather.
- Fit perfectly to offer warmth and protection for mild weather.
- Suede forefinger to wipe visor.
- Padded palm for comfort during longer rides.

Shell: Cow Leather

446313 · S, M, L, XL, 2XL · Black (90)

\$54.99



SPORTSWEAR

New LONG SLEEVE RYKER TEE

95% Cotton Jersey, 5% Spandex

454232 · S, M, L, XL, 2XL, 3XL · Grey (09), Pink (36)

\$29.99



New JESS LONG SLEEVE TEE

95% Cotton Jersey, 5% Spandex

454224 · XS, S, M, L, XL, 2XL · Pink (36), Black (90)

\$34.99



TECHNICAL LONG SLEEVE TEE

· Stretchable technical fabric provides easy movement.

92% Polyester, 8% Spandex

454146 · S, M, L, XL, 2XL, 3XL · Black (90)

\$59.99



BACK

New RIDE TEE

95% Cotton, 5% Spandex

454220 · S, M, L, XL, 2XL, 3XL · White (01), Grey (09)

\$24.99



New LOGO TEE

95% Cotton, 5% Spandex

454222 · XS, S, M, L, XL, 2XL · Yellow (10), Pink (36)

\$24.99



New RYKER TEE

95% Cotton Jersey, 5% Spandex

454231 · S, M, L, XL, 2XL, 3XL · White (01), Grey (09)

\$24.99



New CAN-AM RIDE TEE

- Comfortable, breathable, and stretchable cotton/spandex blend.
- Ride print on the front, Can-Am logo on left sleeve.

95% Cotton, 5% Spandex

454204 · S, M, L, XL, 2XL, 3XL · Yellow (10), Navy (89), Black (90)

\$24.99



New RYKER ZIPPED HOODIE

60% Cotton, 40% Polyester Fleece

454235 · S, M, L, XL, 2XL

Heather Grey (27), Navy (89)

\$79.99



New RIDING TUBE

- Multi-purpose, stretch and comfortable tubular headwear.
- 12 different configurations: Bandana, headband, balaclava and more.
- Protects from sun, wind or cold.
- Does not absorb water/dry fast.
- Keeps hair out of face.
- Flat locked seams to avoid skin chafing.

88% Polyester Jersey, 12% Spandex

4486190090

\$14.99



New RYKER CAP

· Plastic size-adjustment tab.

55% Cotton, 45% Polyester

447728 · One size · Grey (09), Wine (32), Black (90)

\$24.99



New JANE CAP

· Plastic size-adjustment tab.

80% Polyester, 20% Polyurethane

447716 · One size · Wine (32), Black (90)

\$24.99



New LADIES' RIDE CAP

· Plastic size-adjustment tab.

100% Cotton

447681 · One size · Navy (89), Black (90)

\$24.99



BAGS

CAN-AM ALL ELEMENT DRY BACKPACK BY OGIO®

- 100% waterproof roll-top construction.
- Generous 7 Gal (26 L) capacity.
- Back panel allows air flow to keep rider cool.
- Strap-containment system keeps straps secured at high speeds.
- Adjustable sternum strap and dual-density shoulder straps maximize comfort.
- High-visibility 360° reflective screen print and removable high-visibility liner.
- Complete with zippered easy-access front stash pocket and dual-pocket organization panel and laptop/tablet sleeves.

4693020090 · Black

\$139.99



CAN-AM SLAYER GEAR BAG BY OGIO

- Large main compartment with easy access to all gear.
- Large separated boot pocket.
- Zippered accessory pocket.
- Easy grab handles for transport.
- Detachable shoulder strap.
- Heavy-duty reinforced base.

4692940090 · Black

\$104.99



CAN-AM URBAN BACKPACK BY OGIO

- Airport security friendly protective laptop compartment.
- Padded iPad/tablet/e-reader pocket.
- Dual side water bottle/accessory holders.
- Fully adjustable ergonomic shoulder straps.
- Front pocket with two padded accessory compartments and slip pocket.

4692930090 · Black

\$89.99



HELMETS & ACCESSORIES



OPEN FACE HELMETS

CAN-AM N21 OPEN FACE HELMET

Features:

- Super-strong lightweight Lexan polycarbonate shell.
- Replaceable anti-scratch inner visor.
- Fully-removable, washable liner.
- Microlock® quick-release chin strap.
- ECE version not available in North America.

Benefits:

- Superior quality and great look.
- High-impact resistance and comfort.
- Good visibility and practicality.
- Anti-bacterial, anti-fungal and moisture wicking for added comfort and hygiene.
- Added safety and convenience.

Shell: Lexan® Polycarbonate

448481 · DOT · Matte Black (93)

448482 · ECE · Matte Black (93)

S, M, L, XL, 2XL, 3XL

\$189.99



*The helmet shown in the image above is customized and differs from the original product.

DOT ECE22.05

CAN-AM N40-5 JET HELMET

Features:

- Ultra-wide scratch-resistant visor.
- Multi-adjustable anti-fog scratch-resistant sunshield with UV protection.
- Innovative ventilation system.
- Integrated chin straps.
- Bluetooth® communication system ready (sold separately).
- ECE version not available in North America.

Shell: Lexan® Polycarbonate

448572 · DOT · White (01), Magnesium (24), Matte Black (93)

448591 · ECE · Matte Black (93)

XS, S, M, L, XL, 2XL

\$234.99

DOT ECE22.05

Benefits:

- Delivers a superior field of vision for a safer ride.
- Engineered for superior anti-glare, anti-fog capability.
- Ultra-comfortable, and equipped with intelligent ventilation for superior temperature and humidity control.



CROSSOVER HELMET

CAN-AM N40-5 GT CROSSOVER HELMET

Features:

- Bluetooth communication system ready (sold separately).
- Super-strong lightweight, aerodynamically-tuned polycarbonate shell with integrated spoiler.
- Optically-correct face shield protects the entire face while offering a large eye port, and can be changed in seconds.
- Scratch-resistant and anti-fogging UV sunshield.
- Innovative multi-vent air flow system.
- Fully-removable, washable liner, adjustable cheek pads.
- Velour-padded chinstrap with Microlock quick-release retention system.
- Complete with chin guard plugs, side covers and helmet storage pouch.
- ECE version not available in North America.

Shell: Lexan® Polycarbonate

448569 · DOT · White (01), Magnesium (24), Black (90)

448570 · ECE · White (01), Magnesium (24)

XS, S, M, L, XL, 2XL

\$279.99

DOT ECE22.05



Benefits:

- Improved performance, stability and excellent high-impact resistance.
- Ultra-convenient accessory addition or replacement, maintenance, and customization.
- Added safety, exceptional field of vision and convenience.
- Protection against sun, glare and condensation.
- Exceptional ventilation for improved temperature control.
- Anti-bacterial, anti-fungal and moisture wicking for added comfort and hygiene.
- Convenience and comfort.

ONE HELMET, FOUR LOOKS

Quick-change accessories allow you to customize the look and features for every ride.





MODULAR HELMET

CAN-AM N100-5 MODULAR HELMET

Features:

- Bluetooth communication system ready (sold separately).
- Super-strong lightweight, aerodynamically-tuned polycarbonate shell with integrated spoiler.
- Optically-correct UV face shield protects the entire face while offering a large eye port.
- Scratch-resistant and anti-fogging UV sunshield.
- Innovative multi-vent air flow system.
- Fully-removable, washable liner, adjustable cheek pads.
- Velour-padded chinstrap with Microlock[®] quick-release retention system.
- Eyewear compatible.
- Pinlock[®] fog-resistant inner visor.

Shell: Lexan[®] Polycarbonate

448571 · XS, S, M, L, XL, 2XL, 3XL · White (01), Black (90)
\$409.99



Benefits:

- Improved performance, stability and excellent high-impact resistance.
- Added safety, exceptional field of vision and convenience.
- Protection against sun, glare and condensation.
- Exceptional ventilation for improved temperature control.
- Anti-bacterial, anti-fungal and moisture wicking for added comfort and hygiene.
- Convenience and comfort.

FULL FACE HELMET

CAN-AM N87 FULL FACE HELMET

Features:

- Ultra-wide scratch-resistant visor with silicone-sealed profile Pinlock fog-resistant inner visor.
- Multi-adjustable anti-fog scratch-resistant sunshield with UV protection.
- Exclusive technology drives innovative ventilation system.
- Complete with chin guard air intake and rear extractors.
- Patented Microlock double lever retention system.
- Fully-removable and washable double-density micro-perforated Clima-Comfort interior padding.
- Washable cheek pads.
- Bluetooth communication system ready (sold separately).
- ECE version not available in North America.
- Eyewear compatible.

Shell: Lexan[®] Polycarbonate

448592 · DOT · XS, S, M, L, XL, 2XL · Black (90), Matte Black (93)
448593 · ECE · 2XS, XS, S, M, L, XL, 2XL · Matte Black (93)
\$259.99



Benefits:

- Delivers a superior field of vision for a safer ride.
- Engineered for superior anti glare, anti-fog capability.
- Designed to prevent accidental visor opening, closing, and foreign matter infiltration.
- Ultra-comfortable, and equipped with intelligent ventilation for superior temperature and humidity control.
- Stylish, sporty design.

Enhance the Experience.

Get your message across around every curve, into any headwind, and in the noisiest traffic with our in-helmet communication systems. A lot happens when convenience, comfort and cutting-edge technology come together to create effortless communication. Whether you're out for an hour or in it for the long haul, our systems ride with you, letting you stay in touch in almost any driving conditions.

COMMUNICATION SYSTEMS

SENA 30K BLUETOOTH COMMUNICATION SYSTEM

Features:

- Innovative Bluetooth[®] 4.1 communication system with advanced adaptive Mesh-Intercom Technology.
- 13-hour Bluetooth intercom / 8-hour Mesh-Intercom talk time with 1.5-hour charge.
- Open terrain range: Bluetooth 1.6 km (1 mi), Mesh 2 km (1.2 mi).
- Separate headset (HSP) and hands-free profiles (HFP).
- Advanced Noise Control[®].
- Integrated FM Radio with 10 station presets and auto-scan tuning.

Single pack · 4486100090

\$329.99

Dual pack · 4486110090

\$579.99



NOLAN B901-R BLUETOOTH COMMUNICATION SYSTEM

Features:

- 700 meters range rider-to-passenger or vehicle-to-vehicle communication.
- Conference-call ability.
- Full cross-platform Bluetooth compatibility.
- Voice-activated.
- Bluetooth connectivity iOS[®] and Android[®] smartphones and A2DP MP3[®] player with auto-mute during incoming calls.
- Integrated FM Radio with 6 station presets and auto-search and tune.
- Satellite navigator integration via Bluetooth (compatible models only).
- Windows[®] and OS X[®] compatibility.

Single pack · 4485900090

\$319.99



USE THIS CHART TO FIND THE COMMUNICATION SYSTEM THAT FITS YOUR NEEDS.

FEATURES	SENA 30K BLUETOOTH	NOLAN B901-R BLUETOOTH
Bluetooth	4.1	4.1
Universal Intercom	✓	✓
Intercom Connections*	Private mode - 16 riders within 2 km (1.2 mi) range Mesh Intercom - Limitless amount of 30K users within 1.6 km (1 mi) range	"Rider-Passenger" intercom via Bluetooth Bike-to-bike intercom - 0.7 km (0.4 mi) range
Cell Phone and/or GPS and/or MP3 Player Compatible	✓	✓
Advance Noise Control	✓	✓
FM Radio	✓	✓
Voice Command	✓	✓
Smartphone Application	✓ (iPhone and Android)	✓ (iPhone and Android)
Helmet Integration	External (Universal Mounting)	Fully Integrated (Nolan Helmets: N40-5, N87, N100-5)

*Can be connected via Bluetooth to intercom systems of other brands.

HOW TO MEASURE

- For best results, have someone else take measurements.
- Measure body in underwear.
- Tape must be snug but not tight.
- If measurements fall between two sizes, order the larger size.

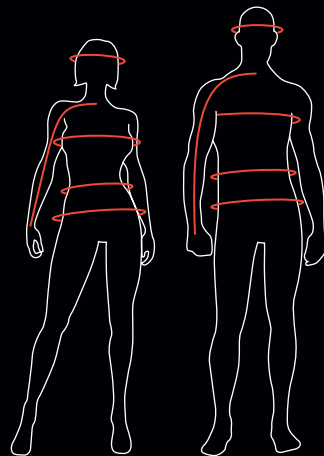

HEAD

Around your head, from the center of the forehead, above the ears and over the natural bump at the back of the head.

CHEST/BUST

Measure under your arms, around the fullest part of your chest.

WAIST

Measure around your waist at the narrowest place.

HIPS

Across the fullest part of the seat.

ARM LENGTH

Let hands down the side in a slightly bent position. Measure from center back neck bone, along shoulder point and elbow, to bottom of wrist bone.

GLOVES

Measure palm width.

MEN'S REGULAR							
	XS	S	M	L	XL	2XL	3XL
Chest (in.)	34-36	36-38	38-41	41-45	45-49	49-53	53-57
Waist (in.)	28-30	30-32	32-35	35-39	39-43	43-48	48-52
Hips (in.)	34-36	36-38	38-41	41-45	45-49	49-53	53-57
Arm Length (in.)	30	31	32	33	34	35	35

MEN'S PLUS SIZE						
	L PLUS	XL PLUS	2XL PLUS	3XL PLUS	4XL PLUS	5XL PLUS
Chest (in.)	44-48	48-52	52-56	56-60	60-64	64-68
Waist (in.)	41-45	45-49	49-54	54-58	58-63	63-68
Hips (in.)	44-48	48-52	52-56	56-60	60-64	64-68
Arm Length (in.)	33	34	35	35	36	36

MEN'S PANTS										
	30	32	34	36	38	40	42	44	46	48
Waist (in.)	30-32	32-34	34-36	36-38	38-40	40-42	42-44	44-46	46-48	48-50
Hips (in.)	36-38	38-40	40-42	42-44	44-46	46-48	48-50	50-52	52-54	54-56
Inseam (in.)	31½	32	32	32	32	32	32	32	32½	32½

LADIES' REGULAR							
	XS	S	M	L	XL	2XL	3XL
Chest (in.)	32-34	34-36	36-39	39-42	42-46	46-50	50-54
Waist (in.)	26-28	28-30	30-33	33-36	36-40	40-44	44-48
Hips (in.)	35-37	37-39	39-42	42-45	45-49	49-53	53-57
Arm Length (in.)	30	30	30½	31	31½	32	33

LADIES' PLUS SIZE						
	M PLUS	L PLUS	XL PLUS	2XL PLUS	3XL PLUS	4XL PLUS
Chest (in.)	39-42	42-45	45-49	49-53	53-57	57-61
Waist (in.)	34-37	37-40	40-44	44-48	48-52	52-56
Hips (in.)	42-45	45-48	48-52	52-56	56-60	60-64
Arm Length (in.)	30½	31	31½	32	33	33

LADIES' PANTS									
	6	8	10	12	14	16	18	20	22
Waist (in.)	28-29	29-30	30-31	31-33	33-35	35-37	37-40	40-42	42-44
Hips (in.)	38-39	39-40	40-41	41-43	43-45	45-47	47-50	50-52	52-54
Inseam (in.)	30	30	30	30	30	30	30½	30½	30½

REMOVABLE BACK PROTECTORS			
	S	M	L
Men's Jacket Sizes	S and M	L to 2XL	3XL to 5XL
Ladies' Jacket Sizes	XS to L	XL to 5XL	

MEN'S GLOVES							
	XS	S	M	L	XL	2XL	3XL
Inches	3	3¼	3½	4	4½	5	5½

LADIES' GLOVES						
	XS	S	M	L	XL	2XL
Inches	2½	2¾	3	3½	4	4½

HELMETS								
	XS	S	M	L	XL	2XL	3XL	
Head Circumference (in.)	20¾-21¼	21½-22	22¾-23¼	23½-23¾	24-24¾	24¾-25½	25½-25¾	

WHAT CODE REPRESENTS YOUR SIZE?

1. Find your size.
2. The corresponding code is **THE CODE** you use to complete the part number on your order.
Example: 440227_90
 Size: M = Code **06**
 Therefore 440227 **06** 90

Code	00	02	04	72	06	09	73	12	14	16	25	27	28	29	30	31	32
Size	OS	XS	S	S/M	M	L	L/XL	XL	2XL	3XL	6	7	8	9	10	11	12
Code	33	34	35	78	92	93	37	38	39	40	41	42	43	44	45	46	
Size	13	14	16	18	20	22	30	32	34	36	38	40	42	44	46	48	
Code	62	63	64	65	66	67	68										
Size	M PLUS	L PLUS	XL PLUS	2XL PLUS	3XL PLUS	4XL PLUS	5XL PLUS										

IF WE SELL IT, WE STAND BY IT.

BRP LIMITED WARRANTY* FOR NEW RIDING PARTS, ACCESSORIES AND RIDING GEAR.

1-YEAR LIMITED WARRANTY**

Genuine BRP Parts and Accessories installed by you or your authorized BRP dealer

Aftermarket Products sold through BRP Riding Gear

4-YEAR LIMITED WARRANTY**

Helmets

GET ALL THE DETAILS FROM YOUR CAN-AM ON-ROAD DEALER

* Purchased at an authorized BRP dealership / distributor or on a BRP-authorized online store. Other exclusions may apply, see complete limited warranty or contact your Can-Am On-Road authorized dealer.
 ** Unless otherwise stipulated or required by law.
 This limited warranty does not apply to factory installed accessories.
 This limited warranty does not apply on Evinrude parts and accessories.

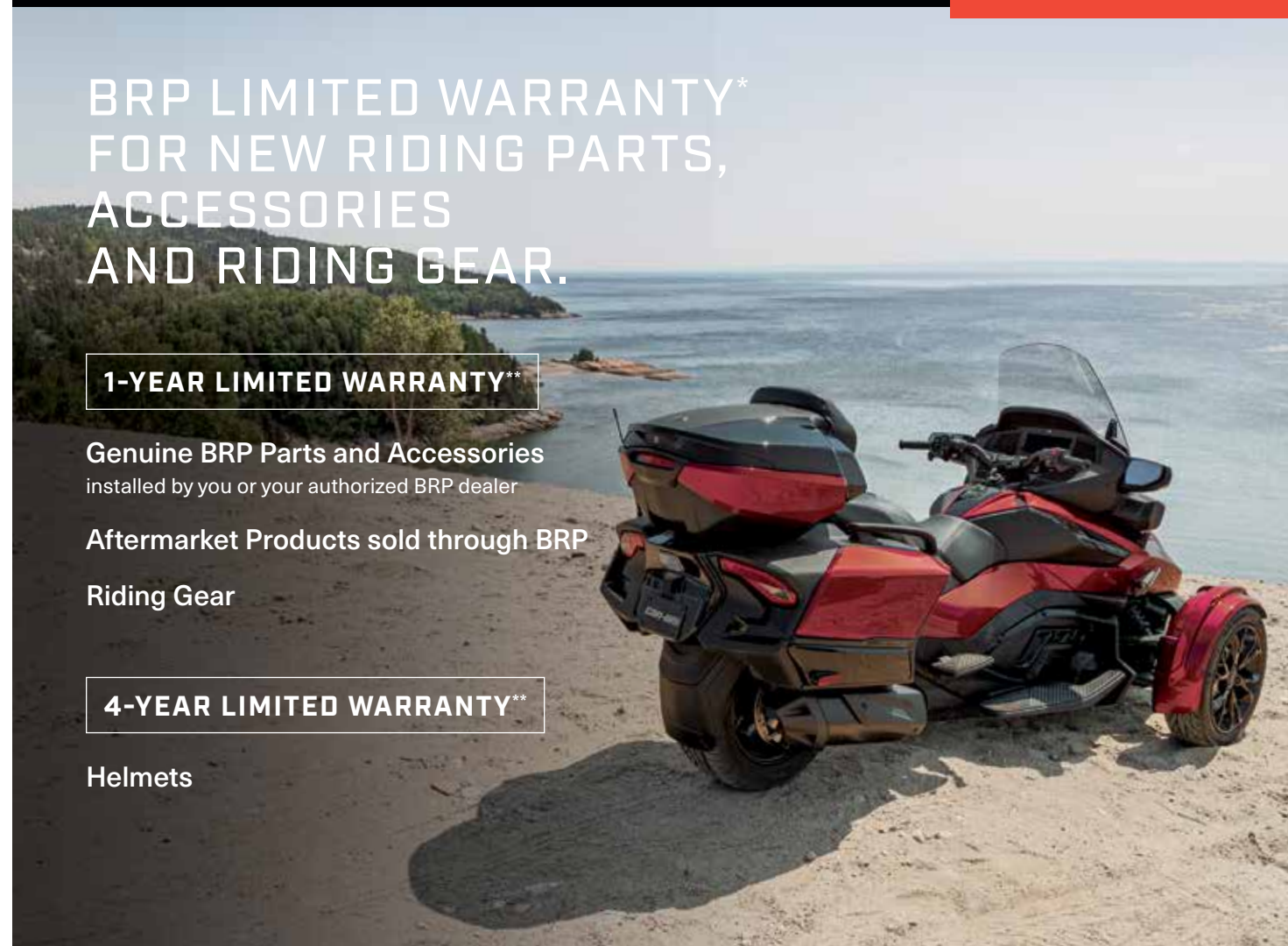



1



2



5



6

TAKE YOUR CAN-AM PRIDE FARTHER THAN EVER BEFORE ALL-NEW CAN-AM LIFESTYLE COLLECTION

MORE THAN 100 PRODUCTS FOR HOME, GARAGE, OFFICE,
TRAVEL, AND MOBILE DEVICES!

Explore them all online at canamonroad.com/Lifestyle or check out the selection in stock at your favorite **Can-Am dealer!**



3



4



7



8

- 1. Golf Bag \$219.99
- 2. Compact Umbrella \$17.99
- 3. Versatile Carry-On Suitcase \$99.99
- 4. 24-Can Cooler Bag \$149.99
- 5. Cargo Backpack \$65.99
- 6. 40-Can Cooler Backpack \$149.99
- 7. Jacquard Throw \$59.99
- 8. Apron \$14.99

KEEP YOUR CAN-AM PERFORMING AT ITS BEST

Remember what made you fall for a Can-Am vehicle? Precisely engineered. Rigorously tested. Factory approved. The Ultimate Can-Am On-Road experience continues with Genuine Can-Am Parts, whether installed by our trusted network of trained dealers—or Do-It-Yourself installed in the comfort of your garage.



*For new genuine parts sold through BRP. Includes items installed by you or authorized BRP dealer. Other exclusions may apply, see complete limited warranty or contact your Can-Am On-Road authorized dealer.

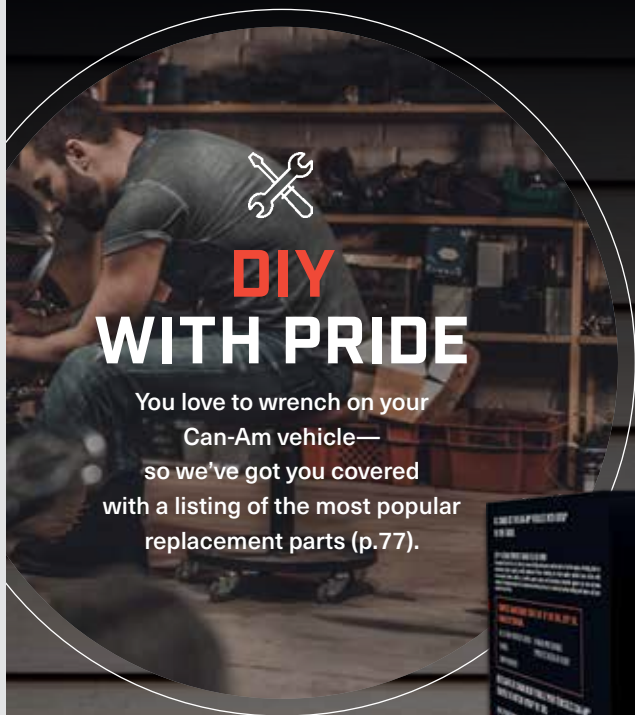

DIY WITH PRIDE

You love to wrench on your Can-Am vehicle—so we've got you covered with a listing of the most popular replacement parts (p.77).



ENGINE OIL CHANGE KIT
All-in-one solution that saves time and money (p.78).

GENUINE CAN-AM PARTS

AIR FILTER

- Prevent airborne contaminants from reaching your engine.
- Protect internal components against premature wear.

Ryker with 900 ACE engine
Spyder RS 2013 and up,
Spyder RT with 998 cc engine 2010-2013,
all Spyder ST models
707800306
\$35.99

Spyder RS 2008-2012
707800188
All Spyder models with 1330 engine
707800483

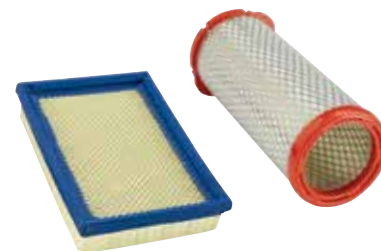

BRAKE PAD KITS

- Brembo® brake systems are considered to be the benchmark for quality and innovation, delivering the ultimate in performance, comfort, quiet, and durability in all road conditions.

All Ryker models
219800445 · Front Left
219800446 · Front Right
219800448 · Rear
\$46.99

Spyder 2013 and up
219800237 · Front
219800239 · Rear
\$61.99

Spyder 2012 and prior
219800164 · Front
\$124.99
219800165 · Rear
\$61.99



OIL FILTER

- Original equipment oil filter, provides superior and reliable filtration levels.

All Ryker models
420956123
\$9.99

Spyder SM5 & SE5
420956747
\$16.99

Spyder SM6 & SE6
420956744
\$16.99



RYKER EXTERNAL SNAP RING

- (Not Illustrated)
- Secures the center lock wheel nut.
- Mandatory in installation of the wheels.

All Ryker models
293370126
\$2.04

RYKER DRIVE BELT

422280654 · 600 ACE engine
\$134.99
417300571 · 900 ACE engine
\$219.99



DRIVE BELTS

- High-tensile strength carbon cord and HNBR rubber construction deliver impressive durability, superior flexibility and reduced noise, while resisting abrasion.
- Tooth-side fabric composed of special low-friction fiber.

Spyder RT 2014 and up
705501304
\$319.99

All Spyder F3 models
705502157
\$319.99



TIRES

- Designed to work in tandem with the Can-Am Spyder innovative Vehicle Stability System to provide an ultra-stable, confident ride.

Ryker Rally Edition model
705402051 · Front
\$97.99
705502600 · Rear
\$159.99

All Ryker models
705401930 · Front
\$92.99
705502453 · Rear
\$154.99

All Spyder models
706202317 · Front · 165/55R 15
706201411 · Front · 165/65R 14
\$97.99
705501464 · Rear · 225/50R 15
\$174.99



NGK® SPARK PLUGS

- NGK spark plugs are recommended by BRP and ensure your Can-Am Spyder's ROTAX engine runs smoothly and delivers optimum power at all times.
- Consistent, reliable performance make it an OEM favorite.

415129670 · MR7BI-8
\$15.49

707000246 · DCP-R8E
\$3.99

219800231 · KR8Bi
\$16.49

415129403 · CR8EB
\$6.19

278002297 · DCP-R9E
\$4.09



YUASA® BATTERIES

- Absorbed Glass Mat (AGM) technology offers durability, electrical reliability, near maintenance-free performance, making it ideal for the Can-Am Spyder.
- Spill-proof design with the ability to hold its charge three times longer than conventional lead-acid batteries in stand-by mode.

219800472
All Ryker models
\$109.99

410922962
21 Amps (YTX24HL)
\$154.99



Visit the CANAMONROAD.COM Parts & Maintenance section to see the full line of Genuine Can-Am Parts.

XPS ENGINE OILS



ALL SET FOR YOUR RIDE?

XPS 4T 5W-40 SYNTHETIC BLEND OIL

- Designed for high-performance off-road, on-road and PWC 4-stroke engines, including turbo or supercharged powersports engines.
- Off-road formula with premium anti-wear and anti-corrosion additives.
- Provides superior engine and transmission protection against rust and corrosion even in extreme conditions.

779133 · 946 ml / 1 quart
779290 · Europe

779134 · 3.785 L / 1 US gallon
779291 · Europe

4T 5W-40 SYNTHETIC BLEND OIL CHANGE KIT

- Ultra-convenient "all-in-one" oil change kit saves time and money.
- Includes XPS Synthetic Blend Oil, oil filter, o-rings and washer.

779247 · SM5

779248 · SE5

779249 · 1330 ENGINE

New 779298 · 600 CC engine

New 779299 · 900 CC engine



XPS MAINTENANCE PRODUCTS

SYNTHETIC GREASE SUSPENSION

- Designed to work specifically with the components found in Can-Am vehicle suspensions.
- It is highly stable and offers optimal lubrication at both extreme cold and high temperatures while protecting suspension components from dirt and moisture, as well as corrosion under extreme washout conditions.

779163 · 14 oz. / 400 g.
779226 · Europe



HIGH PERFORMANCE SUSPENSION FLUID (For FOX® Shocks)

- A synthetic, fade-free formula for servicing FOX shocks.
- Ultra high VI shock oil.
- Engineered viscosity for optimized performance with FOX shocks valving.

779153 · 946 ml / 1 quart



DOT 4 BRAKE FLUID

- Meets or exceeds all DOT3 and DOT4 brake fluid requirements.
- High-temperature formula resists fade, and also conditions seals and o-rings in braking system.

779151 · 12 fl. oz. / 355 ml
779207 · Europe



RACING BRAKE FLUID RS600

- Exceeds DOT4 brake fluid requirements for extreme conditions.
- Extreme, 579-degree boiling point temperature is ideal for high-demand conditions to combat brake fade.
- Will not harm seals or braking system components.
- Should be added only to a clean/unfilled system to avoid dilution and diminished performance.
- Low-moisture formula slows water vapor absorption through multiple heat cycles.

779152 · 12 fl. oz. / 355 ml
779209 · Europe



CARBON FREE FUEL TREATMENT

- Combination of a fuel treatment and a fuel system cleaner that can be used periodically to restore lost starting or throttle performance, as well as maintain fuel system integrity and keep internal engine parts clean.
- It treats fuel for storage and addresses the moisture problems inherent in today's Ethanol-blended fuels, keeping ferrous and soft metal parts clean and free of corrosion.
- Uses patented, state-of-the-art additives.
- Cleans valves, sticky rings and combustion chamber.

779169 · 12 fl. oz. / 355 ml
779220 · Europe



FUEL TREATMENT CARBURETOR CLEANER

- Complete fuel treatment specially formulated to prevent small engine problems caused by Ethanol-blended fuels.
- It removes fuel system gum and varnish that may have accumulated during storage, stabilizes fuel against breakdown for 12 months or more, and adds corrosion protection from moisture for short- and long-term storage.
- It also helps restore throttle response and easy starting.
- It can be used periodically to maintain fuel system integrity, keep carburetor jets clean, and also combat moisture problems caused by Ethanol-blended fuels to keep ferrous and soft metal parts clean and free of corrosion.

779172 · 12 fl. oz. / 355 ml



EXTENDED LIFE PRE-MIXED COOLANT

- Antifreeze/Coolant contains the correct dilution and the necessary additives to prevent corrosion and inhibit cavitation in BRP cooling systems.
- Long-life, 5-year formula specially formulated for BRP vehicles.
- Superior heat transfer.
- Ideal replacement for vehicles that normally use a 2-year antifreeze/coolant (green).
- 5 years (orange).

779150 · 946 ml / 1 quart
779223 · Europe



FUEL STABILIZER

- Ethanol-compatible and will stabilize fuel in your tank to keep it from breaking down and causing hard starting, throttle hesitation and poor run quality.
- Ethanol attracts moisture, and this product contains powerful anti-corrosion additives to protect fuel system components.
- Prevents problems associated with E10 fuels.

779171 · 8 fl. oz. / 236 ml
779183 · Europe



STORAGE OIL

- High-performance fogging oil designed to protect internal engine parts from rust and corrosion.
- This special formula exceeds other fogging oil performance.
- It coats engine internals indefinitely but is burned away through combustion when engine is started after storage.
- Protects engines during non-use or storage.
- Burns complete upon startup.

779173 · 12 oz. / 350 g



ANTI-CORROSIVE LUBRICANT

- Multi-purpose lubricant that can also be used to prevent rust, corrosion and moisture intrusion.
- It contains extreme pressure additives that work as an all-around lubricant for just about anywhere lubrication is needed.

779168 · 12 oz. / 340 g
779168 · Europe



Note: Please contact your nearest dealer for suggested retail prices of oil based products.



EXPLORE AN ENTIRE WORLD OF ADVENTURE WITH ALL OF OUR BRP PRODUCTS. BRP.COM

WHY XPS OIL IS THE PERFECT FIT FOR YOUR ROTAX ENGINE?



Just like you count on Can-Am to help you make the most of every road, you can trust XPS to ensure the long-lasting performance and durability of your Rotax engine.

ULTIMATE PERFORMANCE

Engineered to match the advanced performance of Rotax engines.

UNMATCHED RELIABILITY

Get the most out of every mile on every ride.

MADE FOR THIS

Developed with Rotax engines to deliver the best performance and lubrication in all conditions.



ski-doo LYNX SEA-DOO CAN-AM ROTAX ALUMACRAFT Manitou Evinrude

Visit the CANAMONROAD.COM Parts & Maintenance section to see the full line of XPS lubricants.