

A man in a yellow shirt and sunglasses is steering a boat. The boat is equipped with four Evinrude outboard motors, two on each side. The motors are white with red accents and the Evinrude logo. The boat is moving through the water, creating a wake. The background shows a city skyline across the water.

2019 EVINRUDE OUTBOARDS

EVINRUDE®

FASTEST CLEANEST SMARTEST





ICON 40GT



INNOVATION PROPELS US.

Innovation. It's the drive to a destination just out of reach. It's the feeling of never being satisfied. It's knowing that the job will never be done. Evinrude has spent over a century creating, crafting, rethinking and reimagining.

But the past is not where innovation lies. It's found in today, tomorrow and every moment going forward, where we turn thrilling performance, intelligent design and extreme durability into the world's most powerful boating experiences. And no matter where innovation takes us next, we'll be ready to go even further.

THE EVINRUDE E-TEC G2. AN OUTBOARD SO INTEGRATED WITH THE BOAT, IT'S LIKE THEY WERE MADE FOR EACH OTHER.

SEAMLESS INTEGRATION

Dynamic Power Steering for easy control at any speed. Exclusive i-Trim system that automatically and intelligently trims the engine. Fully integrated digital controls for total command. Boat and outboard work in perfect harmony for an intuitive driving experience.

CUSTOMIZED LOOK

The exterior design features a striking look with a unique shape, modern lines and hundreds of color combinations to choose from. Design one to match your boat and you'll stand out on the water. Because "me too" is no way to go through life.

CLEAN RIGGING

The patented Dual-Axis Rigging System unites critical engine functions, streamlining engine rigging by routing all engine cables and hoses through a single tube. The result is better durability, less clutter and more precious well space.



KEY WEST





INTRODUCING THE 150 HP-200 HP EVINRUDE E-TEC G2.

Boaters asked. We delivered. Best-in-class torque, best-in-class fuel efficiency and the industry's lowest total emissions are now available in 150 HP to 200 HP.

Which means the many groundbreaking innovations and benefits of Evinrude E-TEC G2 technology are now available for more boat types, more boaters and more boating experiences.

DESIGN YOUR OWN EVINRUDE E-TEC G2.

True innovation takes many forms—in this case, hundreds of color combinations. The Evinrude E-TEC G2 is the world's first outboard that allows you to choose the colors of the side panels, the top panels, the front panels and the accent stripes.

Customize an Evinrude E-TEC G2 to perfectly match your boat. Or get an Evinrude boat package with exclusive boat brand colors.

SIDE PANEL COLOR OPTIONS



TOP PANEL COLOR OPTIONS



ACCENT STRIPE COLOR OPTIONS



HORSEPOWER OPTIONS

300 // 250 h.p. // 250 // 225 h.p.
225 // 200 h.p. // 200 // 175
150 h.p. // 150

SHAFT LENGTH OPTIONS¹

20in // 25in // 30in





DESIGN YOUR EVINRUDE E-TEC G2 AT EVINRUDE.COM >



IT LOOKS LIKE NOTHING ELSE.
BECAUSE IT PERFORMS LIKE
NOTHING ELSE.

BEST-IN-CLASS TORQUE

With PurePower Combustion, the Evinrude E-TEC G2 delivers up to 30% more torque than competitive outboards— the most in its class! In fact, every Evinrude E-TEC brings unbeatable low-end torque because of direct injection two-stroke technology.

BEST-IN-CLASS FUEL EFFICIENCY

With an Evinrude E-TEC G2, you'll spend a lot less because you'll burn up to 15% less fuel than the leading four-stroke.² That means more money in your pocket and less time at the pump.

REFINED HANDLING

With the fully integrated i-Trim automatically providing optimal trim, the Dynamic Power Steering for improved handling and the hydrodynamic SLX gearcase to reduce steering effort, the Evinrude E-TEC G2 delivers a silky smooth, yet powerful, steering experience.

¹Torque claim based on BRP-conducted dynamometer testing of Evinrude E-TEC G2 150 H.O., Yamaha 150 SHO and Mercury 150 FourStroke. Actual torque dependent on engine model | ²Fuel economy claim based on BRP-conducted ICOMIA testing of Evinrude E-TEC G2 250 H.O., Yamaha 250 SHO and Mercury OptiMax 250 HP in a test tank to determine ICOMIA average cycle. Actual fuel economy dependent on engine model.

PERFORMANCE TECHNOLOGY

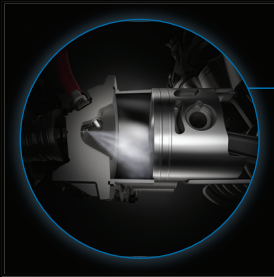

E-TEC DIRECT INJECTION

Our exclusive direct injection technology is the performance standard for outboard engines, delivering the perfect 14:1 air-to-fuel ratio. It's how we get best-in-class torque, fuel efficiency and emissions levels. It's at the heart of Evinrude E-TEC G2 technology.



STARBOARD-STARBOARD DESIGN

Available on 200 H.O. engines and above, the Starboard-Starboard Engine Design delivers faster acceleration, better hole shots, more towing power and better reliability.

I-TRIM WITH FULLY INTEGRATED DIGITAL CONTROLS

The digital controls and gauges are designed to give you complete, crystal-clear engine information for better command, while the breakthrough i-Trim system can automatically provide optimal engine trim.

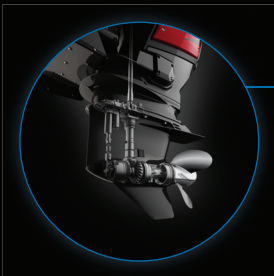

SLX GEARCASE

A sleek, hydrodynamic design reduces steering effort and produces less drag without sacrificing speed and acceleration. The robust gear set brings maximum durability.

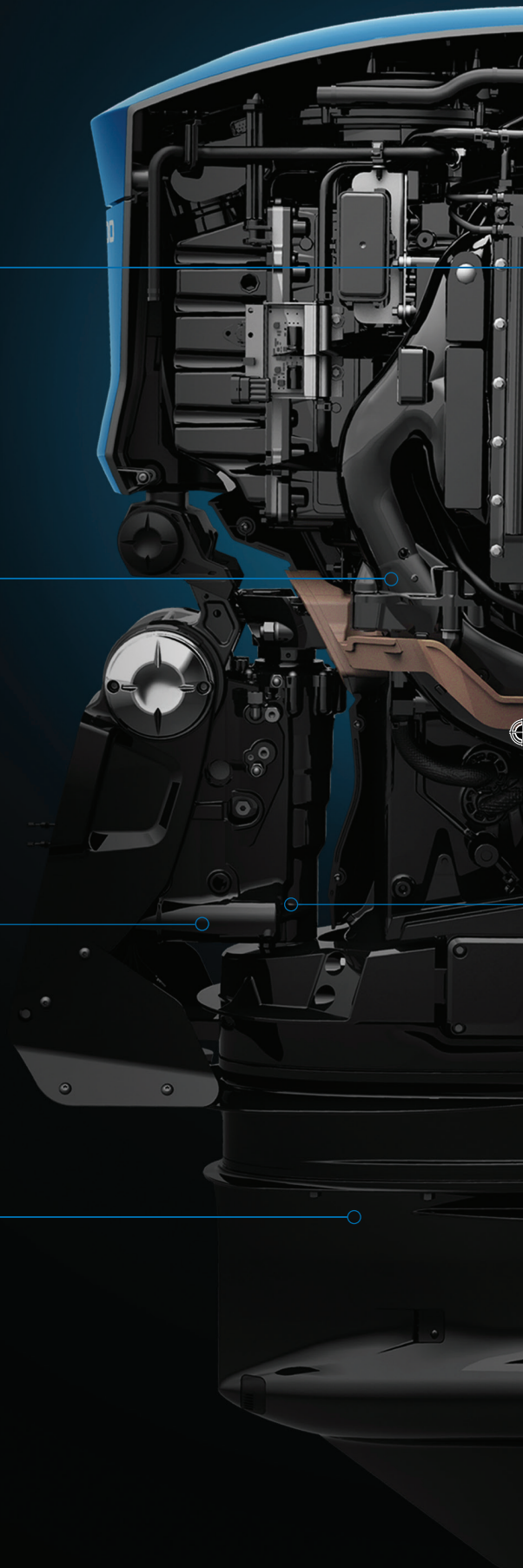



ENGINE MANAGEMENT MODULE

With a lightning-fast microprocessor, the marine-specific EMM is the “brain” of the engine and maintains the instant shift and throttle response, to get your boat on plane faster.

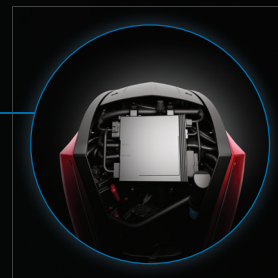

PURE POWER COMBUSTION

We created the most efficient piston/cylinder design in the industry for optimal engine combustion, unrivaled performance and up to 15% better fuel efficiency versus competitive outboards.¹

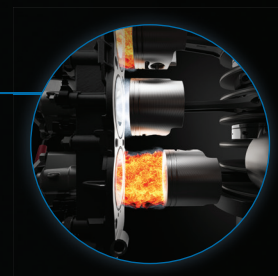

DYNAMIC POWER STEERING

Integrated directly into the midsection, it's designed to adapt steering resistance for better handling and more control in tight turns and big water, when you need it most.

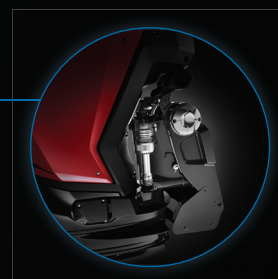

RAKER H.O. PROP

Variable Vent Ports allow you to tune your propeller to match your boat and engine, maximizing holeshots. This industry benchmark fully optimizes the superior torque and power of an Evinrude E-TEC G2.

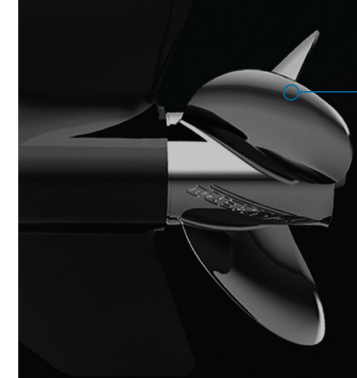

AN ENGINE TO DEPEND ON, SWELL AFTER SWELL.

Sometimes, boating isn't easy. Sometimes, the weather turns, the swells start to build and the knots start filling your stomach. And the only things that matter are your skills and your engine.

Evinrude outboards are designed, built and tested to take a beating and get back up again. Because we know that when conditions are at their worst, an Evinrude engine has to be at its best.

“ My favorite part of owning an Evinrude is its reliability. I know it's going to get me back. ”

RYAN BROWN, EVINRUDE E-TEC G2 OWNER





CORROSION RESISTANCE AND WARRANTY

Stainless-steel components and titanium-oxide coating for toughness. Electro-deposition paint process for uniform and total coverage. And we're so confident in our corrosion resistance that all Evinrude E-TEC G2 engines are backed with an industry-leading 5-year corrosion warranty.

FEWER PARTS

An E-TEC direct injection doesn't require belts, camshafts or exhaust valves, which means there are fewer parts to wear down or malfunction than a traditional engine. Simpler is not only better. Simpler is more durable.

DURABLE COMPONENTS

All Evinrude E-TEC engine pistons are made of an alloy developed by NASA engineers, which is 2.5x stronger than conventional piston alloys. For you, this means increased durability and a longer engine life.

DURABILITY TECHNOLOGY



DUAL-AXIS RIGGING SYSTEM

The patented Dual-Axis Rigging System routes all engine and steering connections through just one tube, which means fewer exposed parts for less wear and tear. One more nagging issue you won't have to worry about.¹

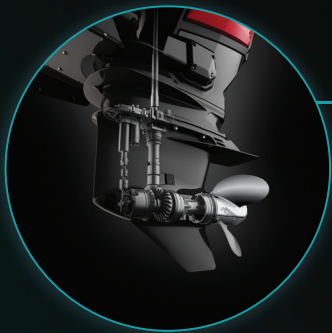

SLX GEARCASE

Inside and out, it's designed for better durability. The weed-shedding leading edge keeps water intakes from clogging. The robust, internal gear set is tuned and tight, ready to take on the roughest waters.¹



HIGH-OUTPUT BELTLESS ALTERNATOR

Industry-leading 50 net amps of battery-charging output on Evinrude E-TEC 90 H.O. models and up. Maximum charging for all your accessories—right down to the blender and stereo.



SLE GEARCASE

The Straight Leading Edge gearcase features high-efficiency water pickups and a weed-slicing shape up front, for a cooler-running engine and ultimate durability and reliability in the long run.²

¹Available with E-TEC G2 engines only | ²Not available on E-TEC G2 engines

*“The ease of maintaining the engine,
the ease of driving it and the warranty
was, to me, a slam dunk.”*

EMILY SPINK, EVINRUDE E-TEC G2 OWNER

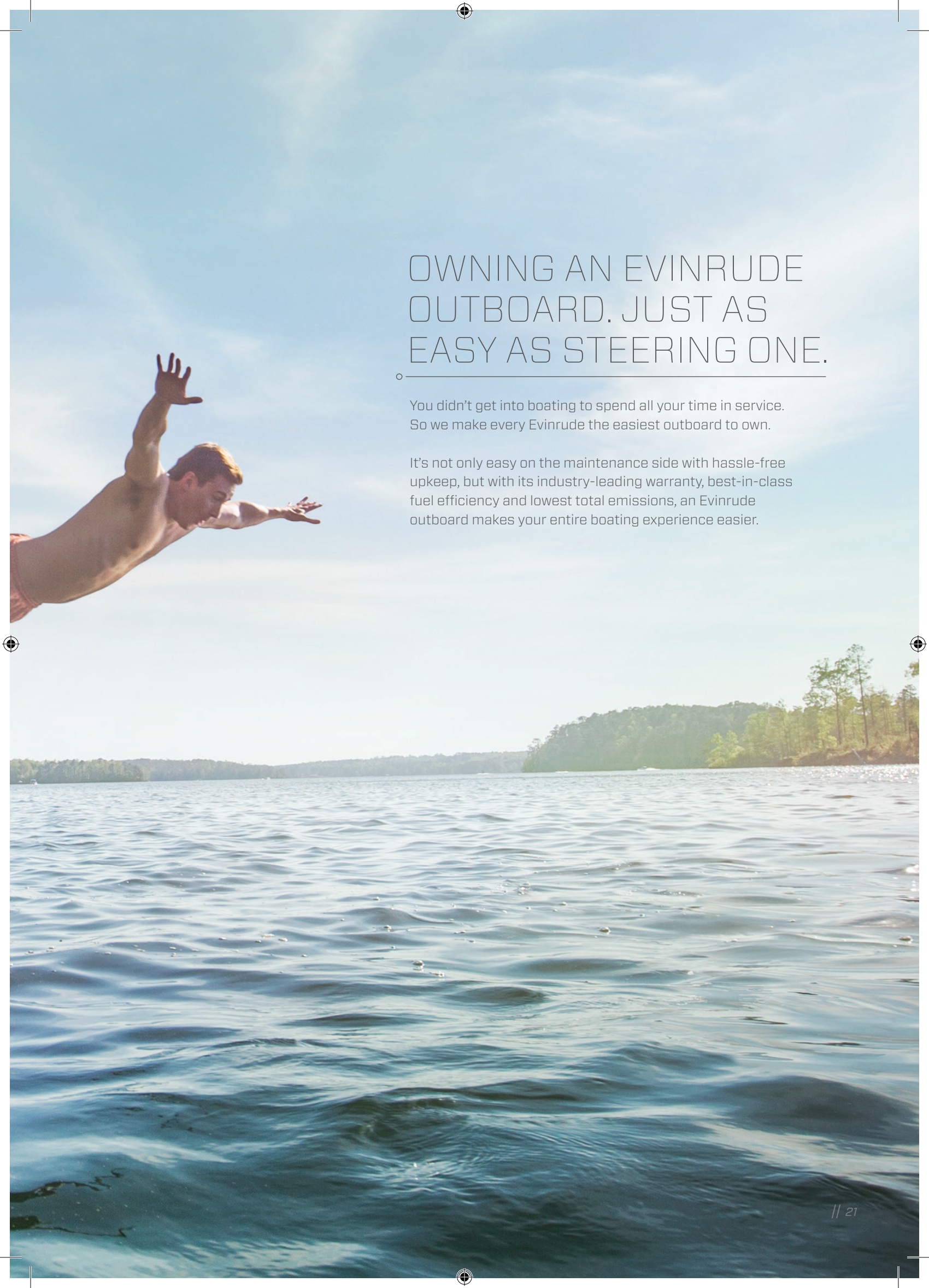

A full-page photograph of a man diving into a large body of water. The man is in mid-air, his body horizontal, with his arms extended forward and his hands open. The water is a deep blue with gentle ripples. In the background, there is a line of green trees under a clear, light blue sky. The overall mood is one of freedom and leisure.

OWNING AN EVINRUDE OUTBOARD. JUST AS EASY AS STEERING ONE.

You didn't get into boating to spend all your time in service.
So we make every Evinrude the easiest outboard to own.

It's not only easy on the maintenance side with hassle-free
upkeep, but with its industry-leading warranty, best-in-class
fuel efficiency and lowest total emissions, an Evinrude
outboard makes your entire boating experience easier.

OWNERSHIP BENEFITS

BEST-IN-CLASS FUEL EFFICIENCY

The PurePower Combustion of the Evinrude E-TEC G2 is so efficient, not a single drop of gas is wasted, so you'll use up to 15% less fuel than the leading four-stroke.¹ Fuel worries evaporate into thin air.

INDUSTRY-LEADING MAINTENANCE SCHEDULE

The Evinrude E-TEC redefined low maintenance with 3 years or 300 hours of no dealer-scheduled maintenance. The Evinrude E-TEC G2 raises the stakes to 5 years or 500 hours of no dealer-scheduled maintenance.

5-YEAR ENGINE AND CORROSION WARRANTY

The industry's best outboard comes with the industry's best warranty: a 5-year engine warranty and 5-year non-declining corrosion warranty.² No one else even comes close.

NO BREAK-IN PERIOD. NO OIL CHANGES.

No 20-hour break-in period like competitors, and no oil changes—ever. So while the others are in the shop getting service, you'll be out on the water.

AUTO-WINTERIZATION/AUTO-STORAGE

We've redefined winterization. Since you can do it yourself in less than four minutes with an Evinrude E-TEC, there is no need for "done until spring" winterizing. Warm day in late autumn? Go fishing and re-fog.

LOWEST EMISSION LEVELS

A more efficient engine is a cleaner engine. In fact, the PurePower Combustion of an Evinrude E-TEC G2 is so clean-burning that it has up to 75% fewer regulated emissions³ than competitive four-strokes, keeping waters clean for you and generations to come.

100% GLOBAL EMISSIONS COMPLIANT

No matter where in the world your boating adventure takes you, the Evinrude E-TEC is welcome. One less thing to get in the way of your time on the water.

¹Fuel economy claim based on BRP-conducted ICOMIA testing of Evinrude E-TEC G2 250 H.O., Yamaha 250 SHO and Mercury OptiMax 250 HP in a test tank to determine ICOMIA average cycle. Actual fuel economy dependent on engine model | ²Available on E-TEC G2 only, in select markets. | ³Emissions claim based on reported certified emissions of Evinrude E-TEC G2 250 H.O., Yamaha 250 SHO and Mercury OptiMax 250 PROXS. Actual emissions dependent on engine model.





THE EVINRUDE LINEUP



E-TEC G2

The Outboard of the Future
150 HP-300 HP



E-TEC

The One That Started It All
25 HP - 135 H.O.



MULTI-FUEL

Fully Submersible Engines
30 HP-55 HP



PORTABLES

Compact, Convenient Power
3.5 HP-15 HP



EVINRUDE E-TEC MULTI-FUEL ENGINES

30-55 HP

BUILT TO MILITARY SPECIFICATIONS

Every day, the U.S. military depends on MFE technology to complete their missions and get their personnel home safely. If Evinrude's technology is tough enough for them, just imagine what it can do for you.

MULTI-FUEL CAPABLE

The first outboard engine ever that's capable of running on multiple fuel types, including kerosene, JP-4, JP-5, JP-8, Jet A and Jet B, as well as standard gasoline. Change fuel settings with the flip of a switch, without compromising performance.

OPTIONAL PUMP JET PROPULSION

Allows the option of propulsion without a propeller, affording additional safety benefits and performance targets for a wider variety of applications. The unique design attaches a large impeller unit to a full gearcase for superior vectored thrust and performance when compared to conventional jet pumps.

EVINRUDE PORTABLES: COMPACT, SIMPLE CONVENIENCE

3.5-15 HP

Operating a portable outboard should never be complicated. It's about getting you out onto the water easily and with just what you need to optimize your time there.

These engines offer many features in one small package. From an integral fuel tank to a flow-through prop for quiet running, they're everything you need to have a better boating experience. CD ignition and a fast-idle choke system make for easier and faster starting, and adjustable steering friction reduces steering effort and fatigue.

The engines are clean too, earning a three-star rating from the California Air Resource Board. And if that wasn't enough, all Evinrude Portables are backed with a 3-year warranty.



RIGGING KITS AVAILABLE

E-TEC G2 C 150 to E 300

DISPLAY SCREENS



NAUTILUS
3.5 CS

ICON 4.3 CTS

ICON 7 CTS

E 25
to E 30

E 40
to E 90

E 90 H.O.
to E 135 H.O.

GAUGES AND ADD-ONS



Tachometer
+ fuel tank

Tachometer
+ Trim gauge

ICON Pro
Tachometer
+ oil tank

ICON ELECTRICAL CONTROLS

TOP		RKIT D10*	RKIT D30	OPTION
CONCEALED		RKIT D20	RKIT D40	OPTION
PREMIUM TOP		OPTION	RKIT D50	OPTION
PREMIUM CONCEALED		OPTION	RKIT D60	OPTION
TWIN			RKIT E10*	RKIT E20
TRIPLE				RKIT E30
QUADRUPLE				RKIT E40

MECHANICAL CONTROLS

SIDE		RKIT A10*	RKIT B10*	RKIT C10*
TOP			RKIT B20	RKIT C20
CONCEALED			RKIT B30	RKIT C30

*Standard rigging kits, included in the price of the engines above.
For the price of the kits and options, contact your local dealer.



ALL-NEW EVINRUDE

iDOCK

JOYSTICK PILOTING



NOW ANYONE CAN DOCK LIKE A PRO

The all-new Evinrude iDock joystick piloting system provides 360 degrees of docking confidence. The intuitive system puts advanced aircraft gyroscope sensor technology into the fingertips of boaters of all experience levels, allowing them to easily maneuver their boat for easy docking in even the toughest conditions. The system connects with the existing integrated hydraulic steering feature of Evinrude E-TEC® G2™ engines to simply and seamlessly integrate with your boat package. And, because it leverages E-TEC G2 architecture, there are no added costs for additional external pumps or installation. This makes joystick docking attainable and instantly adds to the value of any twin engine boat it's installed on. Because 100% of boaters deserve 100% docking confidence.



SPECS	E-TEC G2		E-TEC	
Horsepower	300, 250 H.O. 250, 225 H.O. 225, 200 H.O.	200, 175 150 H.O., 150	200, 175, 150 H.O. 150, 135 H.O.	115 H.O., 115, 90 H.O.
Engine Type	V6 74° E-TEC Direct Injection	V6 66° E-TEC Direct Injection	V6 60° E-TEC Direct Injection	V4 60° E-TEC Direct Injection
Bore x Stroke - mm	98 x 76	86 x 78.7	91 x 66	91 x 66
Displacement - cc	3441	2744	2589	1726
Gear Ratio (shaft length) ¹	1.85:1	2.17:1	1.86:1 (20") 1.85:1 (25")	2.00:1 (20") 2.25:1 (25")
Full Throttle RPM Range	5400-6000 RPM	5000-6000 RPM	5300-6000 RPM	5500-6000 RPM
Weight - kg ²	244	240 225	190	177
Starting ¹	Electric	Electric	Electric	Electric
Controls	Integrated digital shift and throttle	Integrated digital shift and throttle	Mechanical (ICON EST Digital Accessory)	Mechanical
Fuel Induction	E-TEC Direct Injection with stratified low RPM combustion mode	E-TEC Direct Injection with stratified low RPM combustion mode	E-TEC Direct Injection with stratified low RPM combustion mode	E-TEC Direct Injection with stratified low RPM combustion mode
Alternator Output ³	133 Amps Total/ 50 net Dedicated	133 Amps Total/ 50 net Dedicated	133 Amps Total/ 50 Net Dedicated ⁴	133 Amps Total/ 50 Net Dedicated ⁴
Steering ¹	Remote	Remote	Remote	Remote
Hydraulic Steering ¹	Integrated	Integrated	Accessory	Accessory
Electric Dynamic power steering ¹	Integrated	Integrated	Accessory	Accessory
Trim Method ¹	Power Trim & Tilt	Power Trim & Tilt	Power Trim and Tilt	Power Trim and Tilt
Shaft Length - in	20" 25" 30"	20" 25"	20" 25"	20" 25"

¹ May vary based on engine model number. / ² Weight refers to the actual weight (including all fluids) for the lightest model/version of each horsepower listed in that grouping. / ³ Rope-start-only models require optional charging accessory kit. / ⁴ Variable Voltage Computer Controlled 133 Amp. Current amp calculated at 13.5 V. Net dedicated battery charging power output is 50 Amp. / ⁵ Variable Voltage Computer Controlled 81 Amp. Current amp calculated at 13.5 V. Net dedicated battery charging power output is 25 Amp. / ⁶ 56 Amp. Current amp calculated at 13.5 V. Net dedicated battery charging power output is 15 Amp. / ⁷ Electric also has rope capabilities. / ⁸ Available for Government Purchase Only. / Note: Counter Rotation Gearcase with Power Trim & Tilt available on 300-, 250-, 225-, 200-, 175-, 150- and 115-hp engines (excludes High Output models). / ⁹ Non power steering model (Trac +).

Fuel economy: Fuel economy claims are based on laboratory tests utilizing ISO 8178-4 and boat tests performed at BRP facilities. Actual fuel usage will vary depending on the boat, payload, operating conditions, propeller, and driving habits. ***Power Ratings: Evinrude® outboards are powered in accordance with National Marine Manufacturer's Association (NMMA) procedure using the International Council of Marine Industry Associates (ICOMIA) standard 28/83. For all models, a wide variety of props are available at extra cost. A full line of Cyclone™, Hydrus™, SSP®, Raker® II, Raker® H.O., Rogue™, RX4, Viper™, and Rebel™ propellers are available for standard and counter-rotation models.

Specifications: In furtherance of our policy of continual product improvement, we reserve the right to discontinue, substitute, change, or improve the design of any outboard motor at any time, without assuming obligation to modify motors previously manufactured. We reserve the right, at any time, to discontinue or change specifications, price, designs, features, models, or equipment without incurring obligation. The information in this brochure is based on the latest specifications available at the time of printing. See your Evinrude dealer for the latest product information. Some models depicted herein may contain accessories or be shown with options which are available at an extra cost from your Evinrude dealer. Engine performance may vary depending on, among other things, general conditions, ambient temperature, ability, options, modifications, and driver and passenger payload weight, engine type, and optional equipment. Product availability and warranty may vary depending on geographic region.

For advertising purposes, some pictures in this brochure include professional drivers executing maneuvers under ideal and/or controlled conditions. Do not attempt any of these, or any other risky maneuvers, if they're beyond your level of driving ability. Always consult your local dealer when selecting an outboard for your particular needs and carefully heed and pay special attention to your Operator's Guide, and the on-product labeling. Always drive responsibly and safely. Severe injury can result from ignoring warnings, not following the instructions, or improper use of boats and engines. Use common sense and courtesy. Always observe applicable local laws and regulations. Respect the rights of, and keep a safe distance from, other recreationists, bystanders, and the shoreline. Always wear the appropriate clothing, including a Coast Guard-approved P.F.D. as dictated by the circumstances including, but not limited to, the weather, boating conditions, and age and abilities of the occupants. Don't drink and drive.



E-TEC			PORTABLES		MFE [®]				
90, 75		60, 50, 40		30, 25		15, 9.8, 6, 4, 3.5		55, 30	
Inline 3-Cylinder E-TEC Direct Injection		Inline 2-Cylinder E-TEC Direct Injection		Inline 2-Cylinder E-TEC Direct Injection		2-cylinder, 1-cylinder		Inline 2-Cylinder E-TEC Direct Injection	
91 x 66		91 x 66		76 x 64		61x60 55x44 59x45 55x36		91 x 66	
1295		863		577		351 209 123 85.5		863	
2.00:1 (20") 2.25:1 (25")		2.90:1		2.15:1		2.15:1 2.08:1		2.67:1	
5000-5500 RPM		5500-6000 RPM		5500-6000 RPM		4500-6000 RPM		5500-6000 RPM	
145		105		68		52 37 26 18.4		113 70	
Electric		Electric or Rope (40 only)		Electric or Rope ⁷		Electric or Manual		Rope ³	
Mechanical		Mechanical		Mechanical		Remote Control or Tiller Handle		Mechanical	
E-TEC Direct Injection with stratified low RPM combustion mode		E-TEC Direct Injection with stratified low RPM combustion mode		E-TEC Direct Injection with stratified low RPM combustion mode		Carbureted		E-TEC Direct Injection with stratified low RPM combustion mode	
81 Amps Total/ 25 Net Dedicated ⁵		81 Amps Total/ 25 Net Dedicated ⁵		56 Amps Total/ 15 Net Dedicated ⁵		Only on Electric models: 12V, 60W, 5A, 12V, 80W, 6A, 12V, 145W, 12A		81 Amps Total/ 25 Net Dedicated ⁵	
Remote		Remote or tiller		Remote or tiller		Tiller or remote		Tiller	
Accessory		Accessory		Accessory		Accessory		NA	
Accessory		Accessory		Accessory		NA		NA	
Power Trim and Tilt		Power Trim and Tilt or Manual Tilt		Power Trim and Tilt or Manual Tilt		Manual or Power Tilt		Manual Tilt w/ assist cylinder	
20" 25"		20"		15" 20"		15" 20" 25"		20"	

Warranty: BRP 5 YEAR (STANDARD 3 + 2) EXTENDED LIMITED WARRANTY PROGRAMME: (offered only through BRP European Distribution SA and its authorised BRP dealers for Evinrude® outboard engines that are sold to residents of the European Union for recreational use only). This Extended Limited Warranty Programme adds 24 months of BRP Limited Warranty coverage beyond the standard 36 month BRP Warranty (limited to 750 Hrs and 1000 Hrs on G2 Models whichever occurs first) applicable to Evinrude outboard engines provided these Special Conditions are met: Qualification: A qualifying Evinrude outboard engine must be purchased by an EU resident and warranty registered to that resident FOR RECREATIONAL USE ONLY by an authorized BRP dealer or BRP OEM business partner on or after September 27, 2010. Qualifying Evinrude outboard engines include all new and unused Evinrude engines of model year 2010 and higher. Accessories, gauges and rigging components and related parts are not included in this Extended Limited Warranty Program. Demo units that were registered by an authorized BRP dealer upon invoicing by BRP will be eligible for this program provided all other conditions apply. Inspection/Service/Maintenance: The BRP specified pre-delivery inspection process for the Evinrude outboard engine MUST BE completed and documented (see your BRP Service booklet - Service Records section) by your authorized BRP dealer. The service intervals and maintenance recommendations for the outboard engine MUST BE adhered to including the specific maintenance recommendations in the applicable BRP Operator's Guide. This includes all recommended inspections and maintenance performed by an authorized BRP dealer during and following the initial 36 month BRP Limited Warranty period. Use in salt water and heavy use may require specific maintenance and more frequent inspection as outlined in the applicable BRP Operator's Guide. All services (including winterization and pre-season inspection) must be recorded in your Evinrude Service booklet by your authorized BRP dealer. BRP reserves the right to request maintenance records to ensure qualification for this program. ONLY BRP Evinrude certified parts, oils and lubes must be used for service and repairs of the Evinrude outboard engine during the entire eligible period for this program to apply. BRP certified parts may include BRP new or remanufactured parts and components. BRP reserves the right to repair or replace any warranted unit in its sole discretion. The standard BRP Limited Warranty for service parts and accessories applies and is not extended through this program. Improper maintenance and/or use of parts and accessories not manufactured or approved by BRP will cancel this Extended Limited Warranty program. This may also affect your rights under the standard BRP Limited Warranty. Modification/Alteration: Evinrude parts and outboard engines that have been modified or altered from their original production configuration are NOT ELIGIBLE for this BRP Extended Limited Warranty Program and shall disqualify an Evinrude outboard engine from continuation in this program.





ski-doo LYNX SEADOO EVINRUDE ROTAX can-am

