

# GENUINE ACCESSORIES



*Ninja*<sup>®</sup> <sup>®</sup>

**Kawasaki**

# GENUINE ACCESSORIES

Ninja® 



# TABLE OF CONTENTS

<b>NINJA H2™</b> .....	<b>01</b>
<b>NINJA H2™ SX</b> .....	<b>03</b>
<b>NINJA® ZX™-14R</b> .....	<b>07</b>
<b>NINJA® ZX™-10R / RACE KIT PARTS..</b>	<b>09</b>
<b>NINJA® 1000</b> .....	<b>21</b>
<b>Z900RS</b> .....	<b>27</b>
<b>Z900</b> .....	<b>31</b>
<b>NINJA® ZX™-6R</b> .....	<b>33</b>
<b>NINJA® 650</b> .....	<b>37</b>
<b>Z650</b> .....	<b>39</b>
<b>NINJA® 400</b> .....	<b>41</b>
<b>Z400</b> .....	<b>43</b>

## PACKAGES

<b>NINJA® ZX™-10R</b>	
<b>PERFORMANCE PACKAGE</b> .....	<b>44</b>
<b>NINJA® ZX™-6R</b>	
<b>PERFORMANCE PACKAGE</b> .....	<b>45</b>
<b>NINJA® 1000</b>	
<b>PERFORMANCE PACKAGE</b> .....	<b>46</b>
<b>TOURING PACKAGE</b> .....	<b>47</b>
<b>Z900RS</b>	
<b>RETRO PACKAGE</b> .....	<b>48</b>
<b>PERFORMANCE PACKAGE</b> .....	<b>49</b>
<b>Z900</b>	
<b>PERFORMANCE PACKAGE</b> .....	<b>50</b>
<b>NINJA® 650</b>	
<b>SPORT PACKAGE</b> .....	<b>51</b>
<b>NINJA® 400</b>	
<b>PERFORMANCE PACKAGE</b> .....	<b>52</b>



# NINJA H2™ ACCESSORIES

Reduced Reach Handlebar /  
Handlebar Weights

Slip Clutch Assist

Frame Slider Set

\* PROFESSIONAL RIDER ON A CLOSED COURSE \*

# Ninja H2 Ninja H2 Carbon Ninja H2R



## Slipper Clutch Assist

Ninja H2™ (15)  
99994-0840 ..... \$479.95



## Frame Slider Set

Ninja H2™ (16-19) / Ninja H2™ Carbon (17-19)  
99994-0919 ..... \$278.95

Ninja H2™ (15)  
99994-0601 ..... \$278.95



## Handlebar Weight Set

Ninja H2™ / Ninja H2™ R (15-19) / Ninja H2™ Carbon (17-19)  
99994-1047 ..... \$104.95



## ERGO-FIT™ Reduced Reach Handlebar

Ninja H2™ (19) / Ninja H2™ Carbon (19)  
99994-1252 ..... \$269.95

Ninja H2™ (15-18) / Ninja H2™ Carbon (17-18)  
99994-0939 ..... \$276.95



## Carbon Cowling

Ninja H2™ (17-19) / Ninja H2™ Carbon (17-19)  
99994-1006 ..... \$4,699.95



Passenger Seat

SE Passenger Seat

**Passenger Seat**

Ninja H2™ SX (18-19)  
**99994-1122** ..... \$234.95

**SE Passenger Seat**

Ninja H2™ SX (18-19)  
**99994-1123** ..... \$299.95



Ergo-Fit™ Reduced Reach Seat

Ergo-Fit™ Reduced Reach SE Seat

**ERGO-FIT™ Reduced Reach Seat**

Ninja H2™ SX (18-19)  
**99994-1065** ..... \$229.95

**ERGO-FIT™ Reduced Reach SE Seat**

Ninja H2™ SX (18-19)  
**99994-1066** ..... \$304.95

# NINJA H2™ SX ACCESSORIES



## Large Windshield

Ninja H2™ SX (18-19)  
CLEAR 99994-1074 .....\$119.95

## Passenger Seat



## KQR™ 28 Liter Hard Saddlebag Set

# NINJA H2™ SX ACCESSORIES



Grip Heater Set

Frame Slider Set



## Grip Heater Set

Ninja H2™ SX (18-19)  
99994-1069 ..... \$329.95



## Frame Slider Set

Ninja H2™ SX (18-19) / Ninja H2™ SX SE (18-19)  
99994-1095 ..... \$299.95



## Helmet Lock

Ninja H2™ SX (18-19) / Ninja H2™ SX SE (18-19)  
99994-1079 ..... \$114.95



## DC Power Outlet

Ninja H2™ SX (18-19)  
99994-1073 ..... \$84.95



# AKRAPOVIC

## Akrapovic Slip-On Exhaust

Ninja H2™ SX (18-19) / Ninja H2™ SX SE (18-19)  
124879 ..... \$1040.00



## Tank Pad

Ninja H2™ SX (18-19)  
99994-1075 ..... \$79.95



## Knee Pad Set

Ninja H2™ SX (18-19)  
99994-1077 ..... \$54.95





Emerald Blaze Green

Metallic Carbon Gray

**KQR™ 28 Liter Hard Saddlebag Set**

Ninja H2™ SX (18-19) / Ninja H2™ SX SE (18-19)  
99994-0568 ..... \$799.95

**KQR™ 28 Liter Hard Saddlebag Set, Color Panel Set**

Ninja H2™ SX (18-19) / Ninja H2™ SX SE (18-19)  
Emerald Blaze Green (18)  
99994-0422-60R ..... \$149.95  
Metallic Carbon Gray (18)  
99994-0422-51A ..... \$149.95  
Metallic Diablo Black (19)  
99994-0422-660 ..... \$155.95  
Metallic Graphite Gray (19)  
99994-0422-45W ..... \$149.95

**KQR™ 28 Liter Hard Saddlebag Set, Trim Set**

Ninja H2™ SX (18-19) / Ninja H2™ SX SE (18-19)  
Emerald Blaze Green (18)  
99994-0423-60R ..... \$44.95  
Metallic Carbon Gray (18)  
99994-0423-51A ..... \$44.95  
Metallic Diablo Black (19)  
99994-0423-660 ..... \$49.95



**KQR™ 28 Liter Hard Saddlebag Set, One Key System**

Ninja H2™ SX (18-19) / Ninja H2™ SX SE (18-19)  
99994-0407 ..... \$54.95



**KQR™ 28 Liter Hard Saddlebag Set, Fitting Kit**

Ninja H2™ SX (18-19) / Ninja H2™ SX SE (18-19)  
99994-1090 ..... \$164.95



**Center Stand**

Ninja H2™ SX (18-19)  
99994-1265 ..... \$309.95



**KQR™ 28 Liter Hard Saddlebag Set, Liner Set**

Ninja H2™ SX (18-19) / Ninja H2™ SX SE (18-19)  
100LUU-0004 ..... \$145.95



Premium Sport Touring Cover



Premium Cover

**Premium Sport Touring Cover**

Ninja H2™ SX (18-19) / Ninja H2™ SX SE (18-19)  
K99995-877 ..... \$169.95

**Premium Cover**

Ninja H2™ SX (18-19) / Ninja H2™ SX SE (18-19)  
K99995-869A ..... \$135.95

*Ninja*<sup>®</sup> **ZX-14R**<sup>™</sup>



\* PROFESSIONAL RIDER ON A CLOSED COURSE \*

# NINJA® ZX™ -14R ACCESSORIES



## Center Stand

Ninja® ZX™-14R (16-19)  
99994-0751 .....\$211.95



## Passenger Grab Handle

Ninja® ZX™-14R  
Metallic Carbon Gray (18)  
99994-0341-51A .....\$169.95  
Metallic Spark Black (12-13, 17, 19)  
99994-0341-660 .....\$175.95  
Pearl Solar Gray (18)  
99994-0341-36S .....\$169.95



## Deluxe Ninja® Cover

Ninja® ZX™-14R (12-19)  
K99995-843B .....\$155.95

# RACE KIT PARTS

*Ninja* ZX10R *Ninja* ZX10RR

/// FOR CLOSED COURSE ONLY ///



# NINJA® ZX™-10R ACCESSORIES

## RACE KIT PARTS



### Adjustable ECU

Kawasaki Accessories or other items in the Race Kit Parts section are subject to the following conditions:

- These items are intended for closed-course competition only.
  - Alteration of emissions-related components can constitute violation of federal and/or state laws. Substantial fines and penalties can result if used for other than closed-course competition use.
  - Use of unauthorized components and use of a vehicle in competition can affect a vehicle's warranty coverage.
  - Kawasaki Accessories used in competition are not covered by any warranty and are not returnable.
  - Quantities may be limited and replacement parts may not be available.
- Adjustable Racing ECU optimizes adjustability for fuel, ignition timing, over rev, auto shifter, traction control, launch control plus 22 other parameters • Comes with CD and requires Adaptor Cable (57001-011) and Main Harness (26031-2113), sold separately • Fits ABS models but does not support ABS functionality

Ninja® ZX™-10R (19) / Ninja® ZX™-10RR (19)  
21175-1540 ..... \$854.95

Ninja® ZX™-10R (16-18) / Ninja® ZX™-10RR (17-18)  
21175-1205 ..... \$849.95



### Expert Program CD

FI controller program CD for race tuning  
Ninja® ZX™-10R (17-18) / Ninja® ZX™-10RR (17-18)  
57001-0012 ..... \$44.95



Adaptor Cable



Main Harness



Bracket



Pads

### Adaptor Cable

Adaptor Cable connects ECU to computer for adjustability • Purchase as a required component of Adjustable ECU (21175-1205)

Ninja® ZX™-10R (16-19) / Ninja® ZX™-10RR (17-19)  
57001-0011 ..... \$529.95

### Main Harness

Main Harness connects Adjustable ECU for racing purposes • Replaces stock wiring harness • Purchase as a required component of Adjustable ECU (21175-1205) • Requires Oil Catch Tank (52001-0009) and all additional components to properly relocate the voltage regulator • For closed course racing use only and not allowed for use on public roads and highways

Ninja® ZX™-10R (16-19) / Ninja® ZX™-10RR (17-19)  
26031-2113 ..... \$525.95

Ninja® ZX™-10R SE (18-19)  
26031-2471 ..... \$499.95

### Bracket

Ninja® ZX™-10R SE (18-19)  
11057-1762 ..... \$79.95

### Pads

Ninja® ZX™-10R SE (18-19)  
39156-2372 ..... \$1.85

Ninja® ZX™-10R SE (18-19)  
39156-2371 ..... \$6.95

Ninja® ZX™-10R SE (18-19)  
39156-2370 ..... \$0.98

\* PROFESSIONAL RIDER ON A CLOSED COURSE \*

# RACE KIT PARTS

*Ninja* ZX10R *Ninja* ZX10RR  
/// FOR CLOSED COURSE ONLY ///

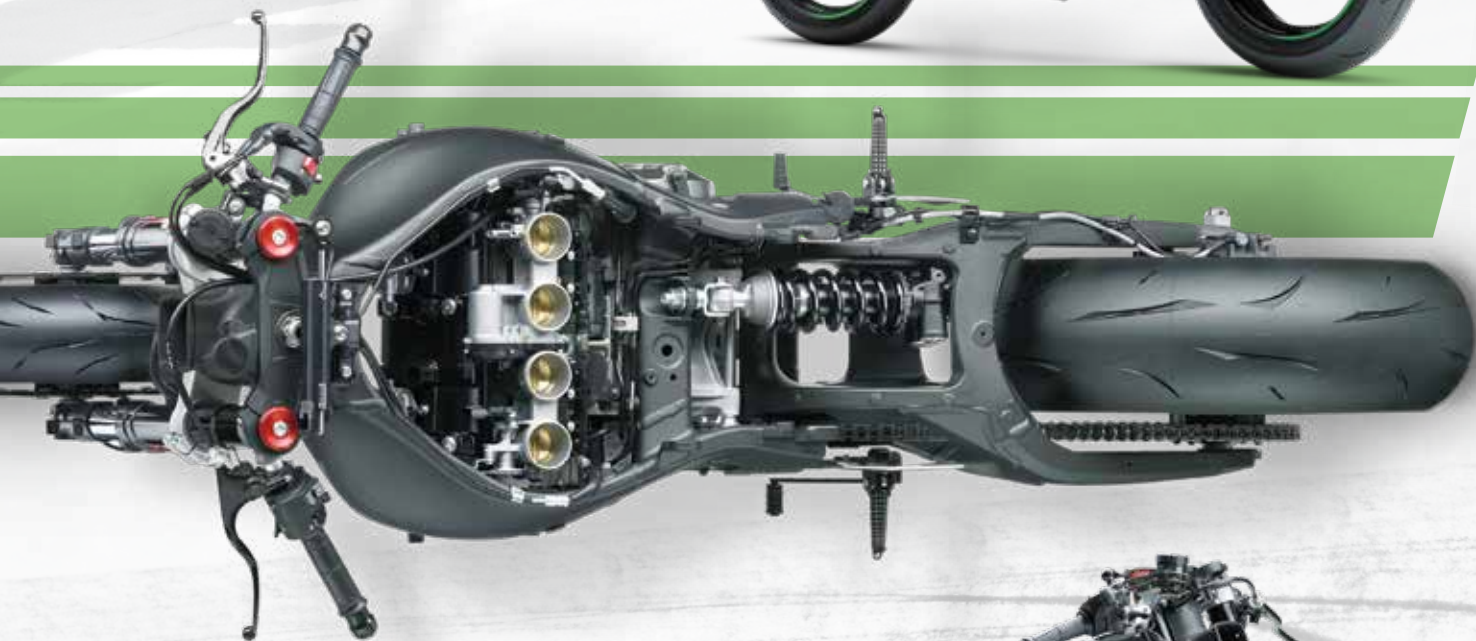

# RACE KIT PARTS

# NINJA® ZX™-10R ACCESSORIES



## STEERING ADJUSTMENT

### Steering Adjustment

When adjusting steering angles use the following tools and/or parts

#### Steering Collar

Provides additional chassis adjustment by moving the head pipe 4mm • Requires Outer Race (92048-1110), sold separately • 2 required

Ninja® ZX™-10R (16-19) / Ninja® ZX™-10RR (17-19)  
92152-2258 ..... \$149.95

#### Outer Race

Ninja® ZX™-10R (16-19) / Ninja® ZX™-10RR (17-19)  
92048-1110 ..... \$6.95

#### Steering Angle Adjuster Collar

Provides chassis steering geometry adjustment to suit track conditions and rider preferences • Requires Outer Race (92048-1110), sold separately • 2 required

Ninja® ZX™-10R (16-19) / Ninja® ZX™-10RR (17-19) 23.5/24.5 Degree Adjustment  
92152-2256 ..... \$164.95

Ninja® ZX™-10R (16-19) / Ninja® ZX™-10RR (17-19) 23/25 Degree Adjustment  
92152-2254 ..... \$149.95

#### Special Tool, Guide

Ninja® ZX™-10R (16-19) / Ninja® ZX™-10RR (17-19)  
56007-0143 ..... \$33.95

#### Special Tool, Bolt

Ninja® ZX™-10R (16-19) / Ninja® ZX™-10RR (17-19)  
120CB0525 ..... \$0.78

### Special Tool, Driver

Ninja® ZX™-10R (16-19) / Ninja® ZX™-10RR (17-19)  
56007-0144 ..... \$45.95

### Special Tool, Shaft

Ninja® ZX™-10R (16-19) / Ninja® ZX™-10RR (17-19)  
56007-0145 ..... \$319.95

### Special Tool, Nut

Ninja® ZX™-10R (16-19) / Ninja® ZX™-10RR (17-19)  
92015-1435 ..... \$3.95

### Special Tool, Puller

Ninja® ZX™-10R (16-19) / Ninja® ZX™-10RR (17-19)  
56007-0146 ..... \$89.95

### Special Tool, Collar Keeper

Ninja® ZX™-10R (16-19) / Ninja® ZX™-10RR (17-19)  
56007-0147 ..... \$221.95

### Special Tool, Bearing Set

Ninja® ZX™-10R (16-19) / Ninja® ZX™-10RR (17-19)  
56007-0148 ..... \$45.95

### Left Hand Swing Arm Pivot Collar, +/- Omm

Swing Arm Pivot Collars help provide swing arm pivot height adjustment +/- OMM to suit track conditions and rider preferences • Requires both Left Hand (92152-2259) and Right Hand (92152-2260) Swing Arm Pivot Collar

Ninja® ZX™-10R (16-19) / Ninja® ZX™-10RR (17-19)  
92152-2259 ..... \$107.95

### Right Hand Swing Arm Pivot Collar, +/- Omm

Ninja® ZX™-10R (16-19) / Ninja® ZX™-10RR (17-19)  
92152-2260 ..... \$99.95

# NINJA® ZX™-10R ACCESSORIES

## RACE KIT PARTS



### Fork Spring

Optional 11.75 N/mm, 10.75 N/mm, or 10.25 N/mm fork spring allows front suspension adjustment for various racing conditions and rider preferences • 2 required

Ninja® ZX™-10R (16-19) / Ninja® ZX™-10RR (17-19)

11.75 N/mm  
44026-0204 .....\$67.95

10.75 N/mm  
44026-0203 .....\$67.95

10.25 N/mm  
44026-0215 .....\$67.95



### Chain Guard

Chain Guard helps protect rider's foot from contacting the chain during race conditions • Requires Flanged Bolt (I30BA0820), sold separately

Ninja® ZX™-10R (16-19) / Ninja® ZX™-10RR (17-19)

55020-0795 .....\$45.95

### Flanged Bolt

Ninja® ZX™-10R (16-19) / Ninja® ZX™-10RR (17-19)

I30BA0820 .....\$3.69



## HEAD GASKETS

### Head Gaskets

Allows adjustment of combustion chamber squish and compression to optimize racing performance

Ninja® ZX™-10R (19) / Ninja® ZX™-10RR (19)

.80MM - 11004-0788 .....\$49.95

.75MM - 11004-0789 .....\$49.95

.70MM - 11004-0790 .....\$49.95

.65MM - 11004-0791 .....\$49.95

Ninja® ZX™-10R (16-18) / Ninja® ZX™-10RR (17-18)

.85MM - 11004-0765 .....\$49.95

.80MM - 11004-0766 .....\$49.95

.75MM - 11004-0767 .....\$49.95

.70MM - 11004-0768 .....\$49.95

.65MM - 11004-0719 .....\$49.95

.60MM - 11004-0720 .....\$49.95

.55MM - 11004-0721 .....\$49.95

.50MM - 11004-0722 .....\$49.95

\* PROFESSIONAL RIDERS ON A CLOSED COURSE \*





# RACE KIT PARTS

*Ninja* ZX10R *Ninja* ZX10RR  
 /// FOR CLOSED COURSE ONLY ///



## OIL TANK

### Oil Tank

Lightweight aluminum catch tank optimizes the capture of oil breather mist under racing conditions • Requires additional components as described below for complete installation • Relocates the voltage regulator

### Oil Tank

Ninja® ZX™-10R (16-19) / Ninja® ZX™-10RR (17-19)  
**52001-0009** ..... \$259.95

### Flanged Bolt

Ninja® ZX™-10R (16-19) / Ninja® ZX™-10RR (17-19)  
**130BB0618** ..... \$1.43

Ninja® ZX™-10R (16-19) / Ninja® ZX™-10RR (17-19)  
**130BD0610** ..... \$3.03

### Upper Bracket

Ninja® ZX™-10R (19) / Ninja® ZX™-10RR (19)  
**11057-2632** ..... \$16.95

Ninja® ZX™-10R (16-18) / Ninja® ZX™-10RR (17-18)  
**11056-1232** ..... \$14.95

### Lower Bracket

Ninja® ZX™-10R (16-19) / Ninja® ZX™-10RR (17-19)  
**11056-1233** ..... \$8.95

### Screw

Ninja® ZX™-10R (16-19) / Ninja® ZX™-10RR (17-19)  
**130BA0620** ..... \$1.43

Upper Bracket

Lower Bracket

Tank Tube

Rubber Damper

Case Tube

Washer

Flanged Bolt

### Washer

Ninja® ZX™-10R (16-19) / Ninja® ZX™-10RR (17-19)  
**92022-304** ..... \$3.02

### Clamp

Ninja® ZX™-10R(16-19) / Ninja® ZX™-10RR (17-19)  
**92171-0338** ..... \$7.06

### Tank Tube

Ninja® ZX™-10R (16-19) / Ninja® ZX™-10RR (17-19)  
**92192-1025** ..... \$12.95

### Case Tube

Ninja® ZX™-10R (16-19) / Ninja® ZX™-10RR (17-19)  
**92192-1026** ..... \$12.95

### Collar

Ninja® ZX™-10R (16-19) / Ninja® ZX™-10RR (17-19)  
**92027-194** ..... \$4.56

### Rubber Damper

Ninja® ZX™-10R (16-19) / Ninja® ZX™-10RR (17-19)  
**92075-277** ..... \$2.48

# RACE KIT PARTS

*Ninja ZX10R Ninja ZX10RR*  
 /// FOR CLOSED COURSE ONLY ///



Camshaft



Valve Springs



Tensioner Rod



Cam Chain Tensioner



Sprocket Bolt



32T Sprocket

## Camshaft

Intake camshaft has 301 degree duration and 10.5mm lift • Requires Sprocket (12046-0034) and 2 Sprocket Bolts (92153-0455)

Ninja® ZX™-10R (16-18)  
**49118-0728 ..... \$205.95**

## 32T Sprocket

Ninja® ZX™-10R (16-19)  
**12046-0034 ..... \$56.64**

## Sprocket Bolt

Ninja® ZX™-10R (16-19)  
**92153-0455 ..... \$2.08**

## Intake Camshaft

Intake Camshaft has 301 degree duration and 10.5mm lift • Requires Exhaust Camshaft (49118-0904), Sprocket (12046-0034), 2 Sprocket Bolts (92153-0455), Intake Valve Spring (49078-0749), and Exhaust Valve Spring (49078-0740)  
 ZX-10RR Camshaft Intake and exhaust camshafts have 301 degree duration and 10.5mm lift • Requires Intake Camshaft (49118-0903), Exhaust Camshaft (49118-0904), Sprocket (12046-0034), 2 Sprocket Bolts (92153-0455), Intake Valve Spring (49078-0749) 8 required, and Exhaust Valve Spring (49078-0740) 8 required

Ninja® ZX™-10R (19) / Ninja® ZX™-10RR (19)  
**49118-0977 ..... \$197.95**

Ninja® ZX™-10RR (17-18)  
**49118-0903 ..... \$194.95**

## Exhaust Camshaft

Ninja® ZX™-10R (19) / Ninja® ZX™-10RR (19)  
**49118-0978 ..... \$197.95**

Ninja® ZX™-10RR (17-18)  
**49118-0904 ..... \$194.95**

## Intake Camshaft, Valve Spring

Intake Valve Spring is a stronger valve spring that can handle the increased lift found in extreme stress applications • Requires Intake Camshaft (49118-0903), Exhaust Camshaft (49118-0904), Sprocket (12046-0034), 2 Sprocket Bolts (92153-0455), and Exhaust Valve Spring (49078-0740) • Intake and exhaust camshafts have 301 degree duration and 10.5mm lift • Requires Intake Camshaft (49118-0903), Exhaust Camshaft (49118-0904), Sprocket (12046-0034), 2 Sprocket Bolts (92153-0455), Intake Valve Spring (49078-0749) 8 required, and Exhaust Valve Spring (49078-0740) 8 required

Ninja® ZX™-10R (19) / Ninja® ZX™-10RR (17-19)  
**49078-0749 ..... \$29.95**

## Exhaust Camshaft, Valve Spring

Ninja® ZX™-10R (19) / Ninja® ZX™-10RR (17-19)  
**49078-0740 ..... \$29.95**

## Cam Chain Tensioner

Manually adjust cam chain for increased reliability

Ninja® ZX™-10R (16-19) / Ninja® ZX™-10RR (17-19)  
**12048-0082 ..... \$409.95**

## Tensioner Rod

Ninja® ZX™-10R (16-19) / Ninja® ZX™-10RR (17-19)  
**13116-1166 ..... \$53.95**

# NINJA® ZX™-10R ACCESSORIES

## RACE KIT PARTS



Connecting Rod Bushings

1/3/5 Journal Crankshaft Bushings

2/4 Journal Crankshaft Bushings

### Connecting Rod Bushings

Anti-seizure bushings help increase wear resistance on stock connecting rod • 8 required, sold separately

Ninja® ZX™-10R (16-19) / Ninja® ZX™-10RR (17-19)

<b>BLUE - 92139-0754</b> .....	<b>\$39.95</b>
<b>BLACK - 92139-0755</b> .....	<b>\$39.95</b>
<b>BROWN - 92139-0756</b> .....	<b>\$39.95</b>
<b>PINK - 92139-0757</b> .....	<b>\$39.95</b>

### Crankshaft Bushings

Anti-seizure bushings help increase wear resistance • 6 or 4 required, sold separately

Ninja® ZX™-10R (16-19) / Ninja® ZX™-10RR (17-19)

<b>Blue 1/3/5 Journal - 92139-0746</b> .....	<b>\$39.95</b>
<b>Black 1/3/5 Journal - 92139-0747</b> .....	<b>\$39.95</b>
<b>Brown 1/3/5 Journal - 92139-0748</b> .....	<b>\$39.95</b>
<b>Pink 1/3/5 Journal - 92139-0749</b> .....	<b>\$39.95</b>
<b>Blue 2/4 Journal - 92139-0750</b> .....	<b>\$39.95</b>
<b>Black 2/4 Journal - 92139-0751</b> .....	<b>\$39.95</b>
<b>Brown 2/4 Journal - 92139-0752</b> .....	<b>\$39.95</b>
<b>Pink 2/4 Journal - 92139-0753</b> .....	<b>\$39.95</b>

### Rear Shock Spacer Set

Adjusts the rear ride height

Ninja® ZX™-10R (16-19) / Ninja® ZX™-10RR (17-19)

<b>92026-0724</b> .....	<b>\$64.95</b>
-------------------------	----------------

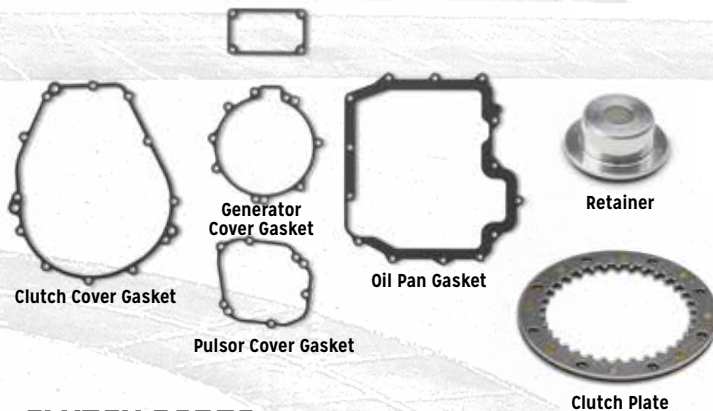

Clutch Cover Gasket

Generator Cover Gasket

Pulsor Cover Gasket

Oil Pan Gasket

Retainer

Clutch Plate

### CLUTCH PARTS

#### Clutch Parts

Reusable gasket for easier removal

#### Clutch Cover Gasket

Ninja® ZX™-10R (16-19) / Ninja® ZX™-10RR (17-19)

<b>11061-0754</b> .....	<b>\$62.95</b>
-------------------------	----------------

#### Generator Cover Gasket

Ninja® ZX™-10R (16-19) / Ninja® ZX™-10RR (17-19)

<b>11061-0755</b> .....	<b>\$18.95</b>
-------------------------	----------------

#### Pulsor Cover Gasket

Ninja® ZX™-10R (16-19) / Ninja® ZX™-10RR (17-19)

<b>11061-0756</b> .....	<b>\$16.95</b>
-------------------------	----------------

#### Oil Pan Gasket

Ninja® ZX™-10R (16-19) / Ninja® ZX™-10RR (17-19)

<b>11061-0757</b> .....	<b>\$64.95</b>
-------------------------	----------------

#### Starter Cover Gasket

Ninja® ZX™-10R (16-19) / Ninja® ZX™-10RR (17-19)

<b>11061-0758</b> .....	<b>\$8.95</b>
-------------------------	---------------

#### Clutch Plate, + 40%

Adjusts clutch setting • Requires 6 Retainers (39108-0005)

Ninja® ZX™-10R (16-19) / Ninja® ZX™-10RR (17-19)

<b>13089-0011</b> .....	<b>\$139.95</b>
-------------------------	-----------------

#### Clutch Plate, + 60%

Ninja® ZX™-10R (16-19) / Ninja® ZX™-10RR (17-19)

<b>13089-0012</b> .....	<b>\$139.95</b>
-------------------------	-----------------

#### Retainer

Ninja® ZX™-10R (16-19) / Ninja® ZX™-10RR (17-19)

<b>39108-0005</b> .....	<b>\$19.95</b>
-------------------------	----------------

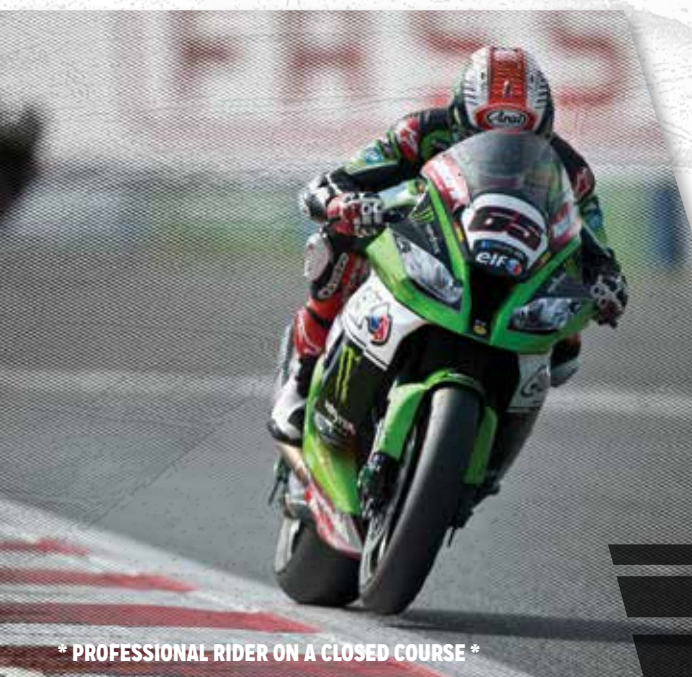

\* PROFESSIONAL RIDER ON A CLOSED COURSE \*

# NINJA® ZX™-10R ACCESSORIES

## RACE KIT PARTS



### TRANSMISSION SHIMS

Increase transmission durability and positive engagement

#### Transmission Shim, 5th Gear In

.8mm - Ninja® ZX™-10R (16-19) / Ninja® ZX™-10RR (17-19)	92200-0225 .....	\$19.95
1.0mm - Ninja® ZX™-10R (16-19) / Ninja® ZX™-10RR (17-19)	92200-0226 .....	\$12.95
1.4mm - Ninja® ZX™-10R (16-19) / Ninja® ZX™-10RR (17-19)	92200-0227 .....	\$12.95

#### Transmission Shim, 6th Gear In

1.2mm - Ninja® ZX™-10R (16-19) / Ninja® ZX™-10RR (17-19)	92200-0229 .....	\$12.95
1.4mm - Ninja® ZX™-10R (16-19) / Ninja® ZX™-10RR (17-19)	92200-0230 .....	\$12.95
1.8mm - Ninja® ZX™-10R (16-19) / Ninja® ZX™-10RR (17-19)	92200-0231 .....	\$12.95
2.0mm - Ninja® ZX™-10R (16-19) / Ninja® ZX™-10RR (17-19)	92200-0232 .....	\$12.95

#### Transmission Shim, 2th Gear In

2.6mm - Ninja® ZX™-10R (16-19) / Ninja® ZX™-10RR (17-19)	92200-0748 .....	\$35.95
2.8mm - Ninja® ZX™-10R (16-19) / Ninja® ZX™-10RR (17-19)	92200-0749 .....	\$35.95
3.0mm - Ninja® ZX™-10R (16-19) / Ninja® ZX™-10RR (17-19)	92200-0750 .....	\$34.95



### Shift Light

A flashing light indicates when shifting is needed • Can be manually set depending on rider preferences

Ninja® ZX™-10R (16-19) / Ninja® ZX™-10RR (17-19)	23016-0602 .....	\$44.95
--	------------------	---------



### Racing Kit Manual Racing Kit Parts manual

Kawasaki Accessories or other items in the Race Kit Parts section are subject to the following conditions:

- These items are intended for closed-course competition only.
- Alteration of emissions-related components can constitute violation of federal and/or state laws. Substantial fines and penalties can result if used for other than closed-course competition use.
- Use of unauthorized components and use of a vehicle in competition can affect a vehicle's warranty coverage.
- Kawasaki Accessories used in competition are not covered by any warranty and are not returnable.
- Quantities may be limited and replacement parts may not be available.

Ninja® ZX™-10RR (19) / Ninja® ZX™-10R (19)	99958-0629 .....	\$19.95
--	------------------	---------

Ninja® ZX™-10RR (17-18) / Ninja® ZX™-10R (16-18)	99958-0223-01 .....	\$19.95
--	---------------------	---------



### ABS Dongle

With ABS Dongle installed, the rider can cancel rear wheel ABS function only or both front and rear by using the Meter Function switch located on the left handlebar • When the ABS dongle is installed, ABS indicator light will flash when ignition is switched on and remain on during engine operation • Cancels ABS function for track use only • This part is NOT for race use or for use on public roads or highways • Not compatible with non-ABS models

Kawasaki Accessories or other items in the Race Kit Parts section are subject to the following conditions:

- These items are intended for closed-course competition only.
- Alteration of emissions-related components can constitute violation of federal and/or state laws. Substantial fines and penalties can result if used for other than closed-course competition use.
- Use of unauthorized components and use of a vehicle in competition can affect a vehicle's warranty coverage.
- Kawasaki Accessories used in competition are not covered by any warranty and are not returnable.
- Quantities may be limited and replacement parts may not be available.

Ninja® ZX™-10R (16-19)	13159-0023 .....	\$19.95
------------------------	------------------	---------



### Secondary Air Plug

The Secondary Air Plug plugs the emissions hose for racing applications

Ninja® ZX™-10R (19) / Ninja® ZX™-10RR (19)	13159-0023 .....	\$10.95
--	------------------	---------

# Ninja ZX10R Ninja ZX10RR

/// FOR CLOSED COURSE ONLY ///



## Front Axle Slider

Durable ABS nylon sliders help provide abrasion protection • All mounting hardware and instructions included

Ninja® ZX™-10R (16-19) / Ninja® ZX™-10RR (17-19)  
 99994-0719 ..... \$129.95

Ninja® ZX™-10R (11-15)  
 99994-0289 ..... \$124.95



## Frame Slider Set

Black molded nylon sliders on metal mounting brackets feature the Kawasaki logo • All mounting hardware and instructions included • Note: Frame Sliders help protect your motorcycle, but will not prevent all types of damage

Ninja® ZX™-10R (11-19) / Ninja® ZX™-10RR (17-19)  
 99994-0210 ..... \$216.95

## Frame Slider Replacement Pads

Black molded nylon sliders on metal mounting brackets feature the Kawasaki logo • All mounting hardware and instructions included • Note: Frame Sliders help protect your motorcycle, but will not prevent all types of damage

Ninja® ZX™-10R (11-19) / Ninja® ZX™-10RR (17-19)  
 55020-0595 - LEFT SIDE ..... \$34.95

55020-0596 - RIGHT SIDE ..... \$34.95



## Knee Pad Set

Help protect your tank's paint finish from scratches and wear and tear • Made with durable textured non-slip vinyl

Ninja® ZX™-10R (16-19)  
 99994-0754 ..... \$54.95



# GENUINE ACCESSORIES

*Ninja ZX10R Ninja ZX10RR*



## AKRAPOVIC

**Akrapovic Slip-On Exhaust**

Ninja® ZX™-10R (16-19) / Ninja® ZX™-10RR (17-19)

123229 ..... \$865.00



\*PROFESSIONAL RIDER ON A CLOSED COURSE\*

# NINJA® ZX™-10R ACCESSORIES



Lime Green



Metallic Fusion Silver / Pearl Blizzard White /  
Pearl Storm Gray / Metallic Flat Spark Black

## Seat Cowl

Ninja® ZX™-10R Lime Green (16-19) 99994-0667-777	\$226.95
Metallic Matte Fusion Silver (18) 99994-0667-60S	\$219.95
Pearl Blizzard White (17) 99994-0667-54X	\$219.95
Pearl Storm Gray (19) 99994-0667-36S	\$219.95
Metallic Flat Spark Black (18) 99994-0667-739	\$235.00



Deluxe Ninja® Cover



Premium Cover

## Deluxe Ninja® Cover

Ninja® ZX™-10R (04-19) / Ninja® ZX™-10RR (17-19) K99995-843B	\$155.95
---	----------

## Premium Cover

Ninja® ZX™-10R (04-19) / Ninja® ZX™-10RR (17-19) K99995-869A	\$135.95
---	----------

# NINJA® 1000 ACCESSORIES



## Grip Heater Set

Ninja® 1000 (17-19)  
99994-0863 ..... \$298.95



## DC Power Outlet

Ninja® 1000 (17-19)  
99994-0485 ..... \$84.95



• GPS Mount  
(GPS Not Included)



## GPS Mount

Ninja® 1000 (17-19)  
99994-0862 ..... \$94.95



## Tank Bag

Ninja® 1000 (11-19)  
K57003-113A ..... \$139.95

## Replacement Tank Bag Tray Cover

Ninja® 1000 (11-19)  
K57003-117 ..... \$21.95



## Soft Top Case

Ninja® 1000 (11-19)  
K57003-104B ..... \$95.95



## Gel Seat

Ninja® 1000 (14-19)  
K53001-249 ..... \$324.95



## ERGO-FIT™ Reduced Reach Seat

Ninja® 1000 (17-19)  
99994-0892 ..... \$169.95



*Ninja*<sup>®</sup> 1000

\* PROFESSIONAL RIDER ON A CLOSED COURSE \*



**Knee Pad Set**

Ninja<sup>®</sup> 1000 (17-19)  
99994-0894 ..... \$49.95



**Crankcase Protector**

Ninja<sup>®</sup> 1000 (17-19)  
99994-0951 ..... \$74.95



**Front Axle Slider**

Ninja<sup>®</sup> 1000 (18-19)  
99994-1276 ..... \$105.95  
Ninja<sup>®</sup> 1000 (17-18)  
99994-0865 ..... \$105.95

# GENUINE ACCESSORIES

*Ninja*® 1000



KJR™ 28-Liter  
Hard Saddlebag Set

Frame Slider Set

# NINJA® 1000 ACCESSORIES



## KQR™ 28 Liter Hard Saddlebag Set

Ninja® 1000 (11-19)  
99994-0564 .....\$899.95



## KQR™ 28 Liter Hard Saddlebag Set, One Key System

Ninja® 1000 (14-19)  
99994-0407 .....\$54.95



## KQR™ 28 Liter Hard Saddlebag Set, Color Panel Set

Ninja® 1000  
Metallic Matte Fusion Silver (18)  
99994-0422-60S .....\$155.95  
Metallic Spark Black (17-19)  
99994-0422-660 .....\$155.95

## KQR™ 28 Liter Hard Saddlebags, Trim Set

Ninja® 1000  
Metallic Matte Fusion Silver (18)  
99994-0423-60S .....\$49.95  
Metallic Spark Black (17-19)  
99994-0423-660 .....\$49.95



## KQR™ 28 Liter Hard Saddlebag Set, Fitting Kit

Ninja® 1000 (17-19)  
99994-0867 .....\$24.95



## Frame Slider Set

Ninja® 1000 (17-19)  
99994-0864 .....\$179.95  
Ninja® 1000 (14-16)  
99994-0437 .....\$315.95



## KQR™ 28 Liter Hard Saddlebag Set, Liner Set

Ninja® 1000 (14-19)  
100LUU-0004 .....\$145.95



# AKRAPOVIC

## Akrapovic Slip-On Exhaust

Ninja® 1000 (14-19)  
123228 .....\$1,260.00

# NINJA® 1000 ACCESSORIES



QQR™ 47 Liter Top Case



Trim



Color Panel



Liner



Backrest



Replacement Pad Set

## QQR™ 47 Liter Top Case

Ninja® 1000 (17-19)  
99994-0899 ..... \$285.95

## QQR™ 47 Liter Top Case, Bracket

Ninja® 1000 (17-19)  
99994-0902 ..... \$478.95

## QQR™ 47 Liter Top Case, Base Plate

Ninja® 1000 (17-19)  
99994-0662 ..... \$65.95

## QQR™ 47 Liter Top Case, One Key System (Type B)

Ninja® 1000 (17-19)  
99994-0528 ..... \$34.95

## QQR™ 47 Liter Top Case, Color Panel

Ninja® 1000  
Aluminum, Black (17-19)  
99994-0656 ..... \$52.95  
Aluminum, Silver (17-19)  
99994-0657 ..... \$52.95

## QQR™ 47 Liter Top Case, Trim

Ninja® 1000  
Metallic Matte Fusion Silver (18)  
99994-0577-60S ..... \$99.95  
Metallic Spark Black (17-19)  
99994-0577-660 ..... \$99.95

## QQR™ 47 Liter Top Case, Liner

Ninja® 1000 (17-19)  
99994-0497 ..... \$84.95

## QQR™ 47 Liter Top Case, Backrest Pad

Ninja® 1000 (17-19)  
99994-0494 ..... \$79.95

## QQR™ 47 Liter Top Case, Base Plate Replacement Pad Set

Ninja® 1000 (17-19)  
131LUU-0167 ..... \$5.95



Metallic Matte Fusion Silver / Metallic Spark Black

## Seat Cowl

Ninja® 1000  
Metallic Matte Fusion Silver (18)  
99994-0897-60S ..... \$216.95  
Metallic Spark Black (17-19)  
99994-0897-660 ..... \$216.95

*Ninja*<sup>®</sup> 1000



Premium Sport Touring Cover

**Premium Sport Touring Cover**

Ninja<sup>®</sup> 1000 (11-19)  
K99995-877 .....\$169.95

**Deluxe Ninja<sup>®</sup> Cover**

Ninja<sup>®</sup> 1000 (11-19)  
K99995-843B .....\$155.95

**Premium Cover**

Ninja<sup>®</sup> 1000 (11-19)  
K99995-869A .....\$135.95



Deluxe Ninja<sup>®</sup> Cover



Premium Cover

# Z900RS



## Frame Slider Set

Z900RS (18-19) / Z900RS CAFE (18-19)  
99994-1010 ..... \$249.95



## Front Axle Slider

Z900RS (18-19) / Z900RS CAFE (18-19)  
99994-0837 ..... \$119.95



## Tank Pad

Z900RS (18-19) / Z900RS CAFE (18-19)  
99994-1011 ..... \$49.95



## Tank Emblem Set

Z900RS (18-19) / Z900RS CAFE (18-19)  
99994-1020 ..... \$89.95



# AKRAPOVIC

## Akrapovic Slip-On Exhaust

Z900RS (18-19) / Z900RS CAFE (18-19)  
125476 ..... \$759.95

# Z900RS ACCESSORIES



# Z900RS ACCESSORIES



## Smoked Wind Deflector

Z900RS (18-19)  
99994-1021.....\$349.95

## Passenger Grab Bar

Z900RS (18-19) / Z900RS CAFE (18-19)  
99994-1013.....\$179.95



## Grip Heater Set

Z900RS (18-19) / Z900RS CAFE (18-19)  
99994-1219.....\$329.95

## Center Stand

Z900RS (18-19) / Z900RS CAFE (18-19)  
99994-1017.....\$274.95



## Meter Trim

Z900RS (18-19) / Z900RS CAFE (18-19)  
99994-1016.....\$67.95



# Z900RS



Ergo-Fit™ Reduced Reach Seat

Ergo-Fit™ Z900RS Stock Seat

## ERGO-FIT™ Reduced Reach Seat

Z900RS (18-19) / Z900RS CAFE (18-19)  
99994-1022 .....\$399.95

## ERGO-FIT™ Z900RS Stock Seat

Z900RS (18-19) / Z900RS CAFE (18-19)  
99994-1023 .....\$405.02



## KYB Fork Cap Set

Z900RS (18-19) / Z900RS CAFE (18-19) Black  
99994-1019 .....\$239.95

Z900RS (18-19) / Z900RS CAFE (18-19) Gold  
99994-1108 .....\$239.95



## Oil Filler Cap

Z900RS (18-19) / Z900RS CAFE (18-19) Gold  
99994-1106 .....\$69.95

Z900RS (18-19) / Z900RS CAFE (18-19) White  
99994-1018 .....\$69.95

Z900RS (18-19) / Z900RS CAFE (18-19) Black  
99994-1229 .....\$69.95

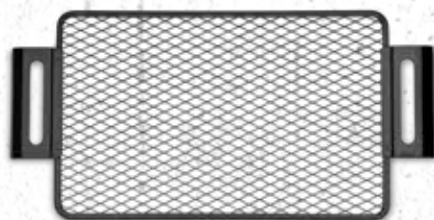

## Radiator Trim

Z900RS (18-19) / Z900RS CAFE (18-19)  
99994-1012 .....\$104.95



## Side Grip Set

Z900RS (18-19) / Z900RS CAFE (18-19)  
99994-1014 .....\$149.95



## Premium Cover

Z900RS (18-19) / Z900RS CAFE (18-19)  
K99995-869A .....\$135.95

# Z<sup>®</sup> 900

\* PROFESSIONAL RIDER ON A CLOSED COURSE \*



### Smoked Wind Deflector

Z900 (17-19)  
99994-0834 .....\$126.95



### DC Power Outlet

Z900 (17-19)  
99994-0838 .....\$125.95



## AKRAPOVIC

### Akrapovic Slip-On Exhaust

Z900 (17-19)  
123230 .....\$760.00

# Z900 ACCESSORIES



## Crankcase Protector

Z900 (17-19)  
99994-0868 ..... \$125.95



## Tank Pad

Z900 (17-19)  
99994-0832 ..... \$64.95



## Knee Pad Set

Z900 (17-19)  
99994-0833 ..... \$59.95



## Radiator Trim

Z900 (17-19)  
99994-0871 ..... \$129.95



## Front Axle Slider

Z900 (17-19)  
99994-0837 ..... \$119.95



## Frame Slider Set

Z900 (17-19)  
99994-0836 ..... \$249.95



Candy Persimmon Red



Metallic Spark Black / Metallic Spark Black / Pearl Mystic Gray / Pearl Flat Spark Black / Metallic Moondust Gray

## Seat Cowl

Z900

Candy Persimmon Red (18)  
99994-1111-A5 ..... \$229.95

Metallic Spark Black (18)  
99994-1111-660 ..... \$229.95

Metallic Spark Black (17-18)  
99994-0835-660 ..... \$229.95

Pearl Mystic Gray (18)  
99994-1111-36P ..... \$229.95

Pearl Flat Spark Black (19)  
99994-1111-739 ..... \$229.95

Metallic Moondust Gray (19)  
99994-1111-25X ..... \$229.95



## ERGO-FIT™ Extended Reach Seat

Z900 (17-19)  
99994-0931 ..... \$185.95



## Premium Cover

Z900 (17-19)  
K99995-869A ..... \$135.95

# NINJA® ZX™-6R ACCESSORIES



## Steering Damper

Ninja® ZX™-6R (13-19)  
99994-0350 ..... \$709.95



## Frame Slider Set

Ninja® ZX™-6R (13-19)  
99994-0349 ..... \$199.95

## Frame Slider Set, Replacement Pad Set

Ninja® ZX™-6R (13-19)  
39156-0758 ..... \$83.95



## Head Gasket, .70MM

Ninja® ZX™-6R (07-19) .70mm  
11004-0067 ..... \$28.95

## Head Gasket, .60MM

Ninja® ZX™-6R (07-19) .60mm  
11004-0068 ..... \$29.95

## Head Gasket, .55MM

Ninja® ZX™-6R (07-19) .55mm  
11004-0069 ..... \$29.95

## Head Gasket, .50MM

Ninja® ZX™-6R (07-19) .50mm  
11004-0070 ..... \$30.95

## Head Gasket, .45MM

Ninja® ZX™-6R (07-19) .45mm  
11004-0071 ..... \$30.95



# AKRAPOVIC

## Akrapovic Slip-On Exhaust

Z900 (17-19)  
125354 ..... \$980.95

# GENUINE ACCESSORIES

*Ninja* ZX-6R

\* PROFESSIONAL RIDER ON A CLOSED COURSE \*



# Ninja ZX-6R

\* PROFESSIONAL RIDER ON A CLOSED COURSE \*



# NINJA® ZX™-6R ACCESSORIES



Carbon Print

## Tank Pad, Carbon Print

Ninja® ZX™-6R (09-19) Carbon Print  
168TPT-0061..... \$49.95



## Front Axle Slider

Ninja® ZX™-6R (19)  
99994-1119..... \$119.95



## Soft Top Case

Ninja® ZX™-6R (09-19)  
K57003-105A..... \$95.95

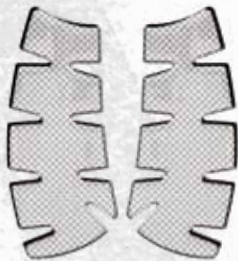

## Knee Pad Set, Carbon Print

Ninja® ZX™-6R (09-19) Knee Pad Set, Carbon Print  
168TPT-0063..... \$49.95



Lime Green



Metallic Flat Spark Black / Metallic Spark Black / Pearl Storm Gray

## Seat Cowling

Ninja® ZX™-6R  
Lime Green (19)  
99994-1116-777..... \$155.95  
Metallic Flat Spark Black (19)  
99994-1116-739..... \$155.95  
Metallic Spark Black (19)  
99994-1116-660..... \$155.95  
Pearl Storm Gray (19)  
99994-1116-36S..... \$155.95



## Deluxe Ninja® Cover

Ninja® ZX™-6R (09-19)  
K99995-843B..... \$155.95



## Premium Cover

Ninja® ZX™-6R (09-19)  
K99995-869A..... \$135.95

# NINJA® 650 ACCESSORIES



## Frame Slider Set

Ninja® 650 (17-19)  
99994-0797 ..... \$229.95



## DC Power Outlet

Ninja® 650 (17-19)  
99994-0485 ..... \$84.95



## Tank Pad

Ninja® 650 (17-19)  
99994-0804 ..... \$59.95



## Knee Pad Set

Ninja® 650 (17-19)  
99994-0805 ..... \$59.95

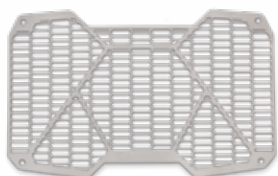

## Radiator Trim

Ninja® 650 (17-19)  
99994-0795 ..... \$99.95



30 Liter Top Case



Backrest Pad



Pearl Storm Gray / Candy Plasma Blue / Metallic Spark Black

## 30 Liter Top Case

Ninja® 650 (17-19)  
99994-0937 ..... \$105.95

## 30 Liter Top Case Bracket

Ninja® 650 (17-19)  
99994-0799 ..... \$155.95

## 30 Liter Top Case, Color Panel

Ninja® 650  
Pearl Storm Gray (18)  
99994-0938-36S ..... \$99.95  
Candy Plasma Blue (18)  
99994-0938-72S ..... \$99.95  
Metallic Spark Black (17, 19)  
99994-0938-660 ..... \$99.95

## 30 Liter Top Case Backrest Pad

Backrest Pad adds passenger comfort with an integrated design that attaches to the top case.  
Ninja® 650 (17-19)  
99994-0800 ..... \$64.95

## 30 Liter Top Case Base Plate, Replacement Pad Set

Ninja® 650 (17-19)  
131LUU-0038 ..... \$5.95



Candy Lime Green

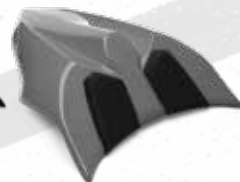
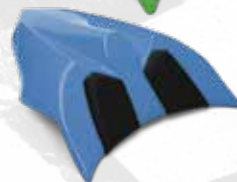

Candy Plasma Blue / Metallic Spark Black / Pearl Storm Gray

## Seat Cowl

Ninja® 650  
Candy Lime Green (17-18)  
99994-0796-777 ..... \$209.95  
Candy Plasma Blue (18)  
99994-0796-723 ..... \$209.95  
Metallic Spark Black (17)  
99994-0796-660 ..... \$209.95  
Pearl Storm Gray (18)  
99994-0796-36S ..... \$209.95



# Ninja® 650



Tall Windscreen

### Tall Windscreen

Ninja® 650 (17-19)  
 99994-0811.....\$109.95



### ERGO-FIT™ Extended Reach Seat

Ninja® 650 (17-19)  
 99994-1062.....\$175.95



### Deluxe Ninja® Cover

Ninja® 650 (12-19)  
 K99995-843B.....\$155.95



### U-Lock 270mm

Ninja® 650 (12-19)  
 17810S-0003.....\$145.95

### U-Lock Bracket

Ninja® 650 (17-19)  
 99994-0985.....\$34.95



### Premium Cover

Ninja® 650 (12-19)  
 K99995-869A.....\$135.95

# GENUINE ACCESSORIES

**Z<sup>®</sup> 650**



### ERGO-FIT™ Extended Reach Seat

Ninja® 650 (17-19)  
99994-1062 ..... \$175.95



### U-Lock 270mm

Z650 (17-19)  
178L05-0003 ..... \$145.95

### U-Lock Bracket

Z650 (17-19)  
99994-0985 ..... \$34.95

# Z650 ACCESSORIES



Metallic Flat Spark Black

Metallic Matte Covert Green / Metallic Spark Black

## Seat Cowl

Z650	
Metallic Flat Spark Black (19)	
99994-0796-739 .....	\$209.95
Metallic Matte Covert Green (18)	
99994-0796-36T .....	\$209.95
Metallic Spark Black (17-18)	
99994-0796-660 .....	\$209.95



## Frame Slider Set

Z650 (17-19)	
99994-0797 .....	\$229.95



## Knee Pad Set

Z650 (17-19)	
99994-0805 .....	\$59.95

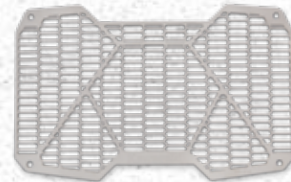

## Radiator Trim

Z650 (17-19)	
99994-0795 .....	\$99.95



30 Liter Top Case

Backrest Pad

Metallic Matte Covert Green / Metallic Spark Black

## 30 Liter Top Case

Z650 (17-18)	
99994-0937 .....	\$105.95

## 30 Liter Top Case Bracket

Z650 (17-19)	
99994-0799 .....	\$155.95

## 30 Liter Top Case, Color Panel

Z650	
Metallic Matte Covert Green (18)	
99994-0938-36T .....	\$99.95
Metallic Spark Black (17-18)	
99994-0938-660 .....	\$99.95

## 30 Liter Top Case Backrest Pad

Z650 (17-19)	
99994-0800 .....	\$64.95

## 30 Liter Top Case Base Plate, Replacement Pad Set

Z650 (17-18)	
131LUU-0038 .....	\$5.95



## Tank Pad

Z650 (17-19)	
99994-0804 .....	\$59.95



## Premium Cover

Z650 (17-19)	
K99995-869A .....	\$135.95

# NINJA® 400 ACCESSORIES

\* PROFESSIONAL RIDER ON A CLOSED COURSE \*



## Tall Windscreen

Ninja® 400 (18-19)  
 99994-1046 .....\$109.95

Tall Windshield



# AKRAPOVIC

## Akrapovic Slip-On Exhaust

Ninja® 400 (18-19)  
 124878 .....\$544.00



### ERGO-FIT™ Extended Reach Seat

Ninja® 400 (18-19)  
**99994-1041** .....\$199.95



DC Power Outlet



Relay Kit

### DC Power Outlet

Ninja® 400 (18-19)  
**99994-1113** .....\$84.95

### Relay Kit

Ninja® 400 (18-19)  
**99994-1040** .....\$19.95



Candy Persimmon Red



Candy Plasma Blue / Ebony / Lime Green / Metallic Spark Black

### Seat Cowl

Ninja® 400  
**Candy Persimmon Red (19)**  
**99994-1038-A5** .....\$159.95  
**Candy Plasma Blue (18)**  
**99994-1038-723** .....\$159.95  
**Ebony (18)**  
**99994-1038-H8** .....\$159.95  
**Lime Green (18)**  
**99994-1038-777** .....\$159.95  
**Metallic Spark Black (18-19)**  
**99994-1038-660** .....\$159.95



### Tank Pad

Ninja® 400 (18-19)  
**99994-1039** .....\$49.95

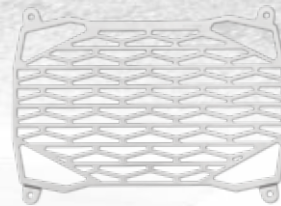

### Radiator Trim

Ninja® 400 (18-19)  
**99994-1048** .....\$64.95



Frame slider Set



Helmet Lock

### Frame Slider Set

Ninja® 400 (18-19)  
**99994-1036** .....\$279.95

### Helmet Lock

Ninja® 400 (18-19)  
**99994-1037** .....\$36.95



Deluxe Ninja® Cover

Premium Cover

### Deluxe Ninja® Cover

Ninja® 400 (18-19)  
**K99995-843B** .....\$155.95

### Premium Cover

Ninja® 400 (18-19)  
**K99995-869A** .....\$135.95

# Z400 ACCESSORIES



## Meter Cover

Z400 (19)  
99994-1128 ..... \$74.95



Metallic Flat Spark Black / Metallic Spark Black

## Lower Cowling

Z400 (19)  
Metallic Flat Spark Black - 99994-1131-739 ..... \$321.95  
Metallic Spark Black - 99994-1131-600 ..... \$321.95



## Knee Pad Set

Z400 (19)  
99994-1129 ..... \$50.95

## Tank Pad

Z400 (19)  
99994-1130 ..... \$24.95



## ERGO-FIT™ Extended Reach Seat

Z400 (19)  
99994-1041 ..... \$199.95

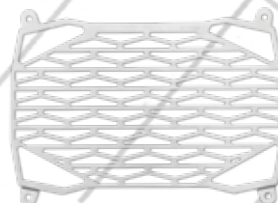

## Radiator Trim

Z400 (19)  
99994-1048 ..... \$64.95



## Frame Slider Set

Z400 (19)  
99994-1287 ..... \$254.95



## Seat Cowl

Z400 (19)  
Metallic Flat Spark Black - 99994-1038-739 ..... \$159.95  
Metallic Spark Black - 99994-1038-660 ..... \$159.95



## Premium Cover

Z400 (19)  
K99995-869A ..... \$135.95

# Ninja ZX-10R PERFORMANCE PACKAGE

• SIMPLE ONE PART NUMBER ORDERING

P/N - **99969-3781**

• PACKAGE ACCESSORIES COVERED  
UNDER VEHICLE WARRANTY

**PACKAGE PRICING**

**\$1,072.95** MSRP

• Discount Pricing—when purchased as a package, total cost is less than when items are purchased individually at regular MSRP pricing.

**Akrapovic Slip-On Exhaust**



**Knee Pad Set**



**Frame Slider Set**



**Front Axle Slider**



- Akrapovic Slip-On Exhaust
- Frame Slider Set

- Front Axle Slider
- Knee Pad Set

• Accessory packages when purchased as part of a new vehicle purchase inherit the same new vehicle limited warranty. Packages or accessories purchased after the new vehicle purchase carry the standard 90 day accessories warranty.

# Ninja ZX-6R PERFORMANCE PACKAGE

• SIMPLE ONE PART NUMBER ORDERING

P/N - **99969-3780**

• PACKAGE ACCESSORIES COVERED  
UNDER VEHICLE WARRANTY

**PACKAGE PRICING**

**\$1,190.95** MSRP

• Discount Pricing—when purchased as a package, total cost is less than when items are purchased individually at regular MSRP pricing.

Knee Pad Set



Tank Pad



Akrapovic  
Slip-On Exhaust



Frame Slider Set



Front Axle Slider



• Accessory packages when purchased as part of a new vehicle purchase inherit the same new vehicle limited warranty. Packages or accessories purchased after the new vehicle purchase carry the standard 90 day accessories warranty.



- Front Axle Slider
- Tank Pad, Carbon Print
- Knee Pad Set, Carbon Print

- Frame Slider Set
- Akrapovic Slip-On Exhaust



# Ninja® 1000 PERFORMANCE PACKAGE

• SIMPLE ONE PART NUMBER ORDERING

P/N - 99969-3778

• PACKAGE ACCESSORIES COVERED UNDER VEHICLE WARRANTY

PACKAGE PRICING

**\$1,598.95** MSRP

• Discount Pricing—when purchased as a package, total cost is less than when items are purchased individually at regular MSRP pricing.

Seat Cowl



Knee Pad Set



Frame Slider Set



Akrapovic Slip-On Exhaust

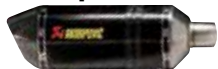

Crankcase Protector



Front Axle Slider



1000



- Front Axle Slider
- Frame Slider Set
- Knee Pad Set

- Crankcase Protector
- Seat Cowl
- Akrapovic Slip-On Exhaust

• Accessory packages when purchased as part of a new vehicle purchase inherit the same new vehicle limited warranty. Packages or accessories purchased after the new vehicle purchase carry the standard 90 day accessories warranty.

# Ninja® 1000

## TOURING PACKAGE

• SIMPLE ONE PART NUMBER ORDERING

P/N - 99969-3779

• PACKAGE ACCESSORIES COVERED  
UNDER VEHICLE WARRANTY

### PACKAGE PRICING

# \$1,563.95

 MSRP

• Discount Pricing—when purchased as a package, total cost is less than when items are purchased individually at regular MSRP pricing.

Saddlebag Set



Gel Seat



DC Power Outlet



Crankcase Protector



Frame Slider Set



# Ninja® 1000



• Accessory packages when purchased as part of a new vehicle purchase inherit the same new vehicle limited warranty. Packages or accessories purchased after the new vehicle purchase carry the standard 90 day accessories warranty.

- DC Power Outlet
- Frame Slider Set
- Crankcase Protector
- Gel Seat

- QQR™ 28 Liter Saddlebag Set
- QQR™ Fitting Kit
- QQR™ One Key System
- QQR™ Color Panel Set
- QQR™ Trim Set

# Z900RS

## RETRO PACKAGE

• SIMPLE ONE PART NUMBER ORDERING

P/N - 99969-3775

• PACKAGE ACCESSORIES COVERED UNDER VEHICLE WARRANTY

PACKAGE PRICING

**\$924.95** MSRP

• Discount Pricing—when purchased as a package, total cost is less than when items are purchased individually at regular MSRP pricing.



Passenger Grab Bar



Tank Emblem Set



Meter Trim



Radiator Trim



Center Stand



Frame Slider Set



Front Axle Slider



- Meter Trim
- Frame Slider Set
- Front Axle Slider
- Tank Emblem Set

- Radiator Trim
- Center Stand
- Passenger Grab Bar

• Accessory packages when purchased as part of a new vehicle purchase inherit the same new vehicle limited warranty. Packages or accessories purchased after the new vehicle purchase carry the standard 90 day accessories warranty.

# Z900RS RETRO PERFORMANCE PACKAGE

• SIMPLE ONE PART NUMBER ORDERING

P/N - 99969-3782

• PACKAGE ACCESSORIES COVERED UNDER VEHICLE WARRANTY

PACKAGE PRICING

**\$1,570.95** MSRP

• Discount Pricing—when purchased as a package, total cost is less than when items are purchased individually at regular MSRP pricing.



• Accessory packages when purchased as part of a new vehicle purchase inherit the same new vehicle limited warranty. Packages or accessories purchased after the new vehicle purchase carry the standard 90 day accessories warranty.

- Meter Trim
- Frame Slider Set
- Front Axle Slider
- Tank Emblem Set

- Radiator Trim
- Center Stand
- Passenger Grab Bar
- Akrapovic Slip-On Exhaust

# Z<sup>®</sup> 900 PERFORMANCE PACKAGE

• SIMPLE ONE PART NUMBER ORDERING

P/N - 99969-3774

• PACKAGE ACCESSORIES COVERED  
UNDER VEHICLE WARRANTY

PACKAGE PRICING

**\$1,182.95** MSRP

• Discount Pricing—when purchased as a package, total cost is less than when items are purchased individually at regular MSRP pricing.

Knee Pad Set



Tank Pad



Smoke Wind Deflector



Radiator Trim



Akrapovic Slip-On Exhaust



Frame Slider Set



- Smoked Wind Deflector
- Tank Pad
- Knee Pad Set

- Radiator Trim
- Frame Slider Set
- Akrapovic Slip-On Exhaust

• Accessory packages when purchased as part of a new vehicle purchase inherit the same new vehicle limited warranty. Packages or accessories purchased after the new vehicle purchase carry the standard 90 day accessories warranty.

# Ninja® 650 SPORT PACKAGE

- SIMPLE ONE PART NUMBER ORDERING  
P/N - 99969-3777
- PACKAGE ACCESSORIES COVERED  
UNDER VEHICLE WARRANTY

**PACKAGE PRICING**  
**\$548.95** MSRP

• Discount Pricing—when purchased as a package, total cost is less than when items are purchased individually at regular MSRP pricing.

Knee Pad Set



Tank Pad



DC Power Outlet



Radiator Trim



Frame Slider Set



Ninja®

650



• Accessory packages when purchased as part of a new vehicle purchase inherit the same new vehicle limited warranty. Packages or accessories purchased after the new vehicle purchase carry the standard 90 day accessories warranty.

- Tall Windscreen
- DC Power Outlet
- Tank Pad

- Knee Pad Set
- Radiator Trim
- Frame Slider Set

Ninja® 400

# PERFORMANCE PACKAGE

• SIMPLE ONE PART NUMBER ORDERING

P/N - 99969-3776

• PACKAGE ACCESSORIES COVERED UNDER VEHICLE WARRANTY

## PACKAGE PRICING

# \$836.95

 MSRP

• Discount Pricing—when purchased as a package, total cost is less than when items are purchased individually at regular MSRP pricing.

Tank Pad



Tall Windscreen



Akrapovic Slip-On Exhaust



Frame Slider Set



- Tall Windscreen
- Tank Pad

- Frame Slider Set
- Akrapovic Slip-On Exhaust

• Accessory packages when purchased as part of a new vehicle purchase inherit the same new vehicle limited warranty. Packages or accessories purchased after the new vehicle purchase carry the standard 90 day accessories warranty.

# Z900RS CAFE



**YOU CAN NOW PURCHASE  
GENUINE KAWASAKI ACCESSORIES  
APPAREL AND GIFTS ONLINE**

 **SHOP NOW!**  
**KAWASAKI.COM/SHOP**

**Kawasaki Motors Corp., U.S.A.**

Manufacturer's suggested retail prices shown. Prices, product and specifications are subject to change without notice or liability. Availability is subject to production, stocking and demand.

[www.kawasaki.com/accessories](http://www.kawasaki.com/accessories)  
P/N: K919NI-ACC

All trademarks, registered trademarks, logos, and copyrights are the property of their respective owners.



**WWW.KAWASAKI.COM**