



 **POLARIS**®

MY18 PGA RZR CAT-INTL



USA | 9930405

MY18 PGA RZR CAT-INTL · 9930405

Unless noted, trademarks are the property of Polaris® Industries Inc. 509® is a registered trademark of Teton Outfitters, LLC. BatteryMINDER® is a registered trademark of VDC Electronics Inc., Bluetooth® is a registered trademark of Bluetooth Sig. Inc., COOLCORE® is a registered trademark of Tempnology LLC., GoPro® is a registered trademark of GoPro Inc., Maxxis® is a registered trademark of Cheng Shin Rubber Ind. Co., Ltd., MB Quart® is a registered trademark of Maxxsonics USA Inc., Rigid® is a registered trademark of Rigid Hitch, Inc., Yeti® is a registered trademark of Yeti Coolers, LLC. Prices and availability are subject to change at any moment. Copyright © 2017 Polaris® Industries. All rights reserved.



 **POLARIS**®

**RZR**®

**2018** ACCESSORIES + APPAREL





# POLARIS®

# RAZR®

This machine is engineered from the inside out to deliver the ultimate combination of power, suspension, agility, comfort, and customization. Allowing everyone from the desert racer to the weekend trail rider to experience **RAZOR SHARP PERFORMANCE®**.

LIGHTING P. 10

WHEELS & TIRES P. 32

AUDIO P. 20

COLOR CUSTOMIZATION P. 48

## 2018 COMPLETE LINE-UP

### XTREME PERFORMANCE



### SPORT



### TRAIL



### SPECIAL EDITION



### 4-SEAT



## CONTENTS

THE JOURNEY TO EXTREME PERFORMANCE	02	THE POWER OF COLOR	48	WINDSHIELDS	62
SHOW & SHINE	04	BARRICADE CAGE	50	STORAGE	64
CONQUER ANY ENVIRONMENT	06	ROOFS	52	POLARIS NORTHSTAR® COOLERS	65
START YOUR BUILD	08	BUMPERS	54	WINCHES & PLOWS	66
LIGHTING	10	PROTECTION	56	TRACKS	67
STAY CONNECTED	18	DOORS	58	SEAT HARNESSSES/ ETC.	68
AUDIO	20	MIRRORS	61	570/170	69
WHEELS & TIRES	32			GARAGE	70
				APPAREL	80



**POLARIS**<sup>®</sup>

ENGINEERED PARTS  
ACCESSORIES & APPAREL

# THE JOURNEY TO EXTREME PERFORMANCE

## DESIGNED

**ONLY POLARIS ENGINEERED ACCESSORIES™** are conceived, designed and fabricated in lockstep with the Polaris RZR® development process. As the vehicle progresses from concept to production, so do the accessories. This ensures a perfect fit and optimal performance.

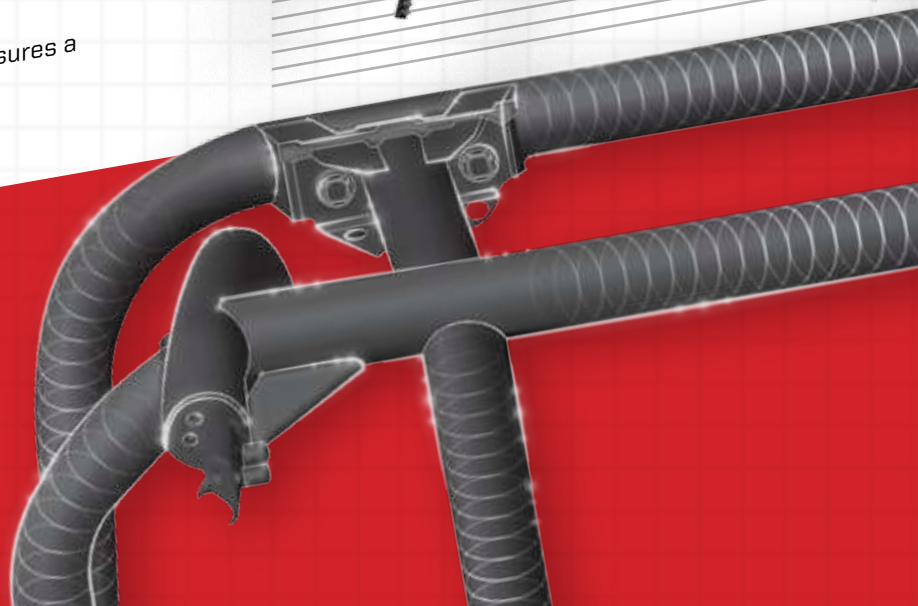
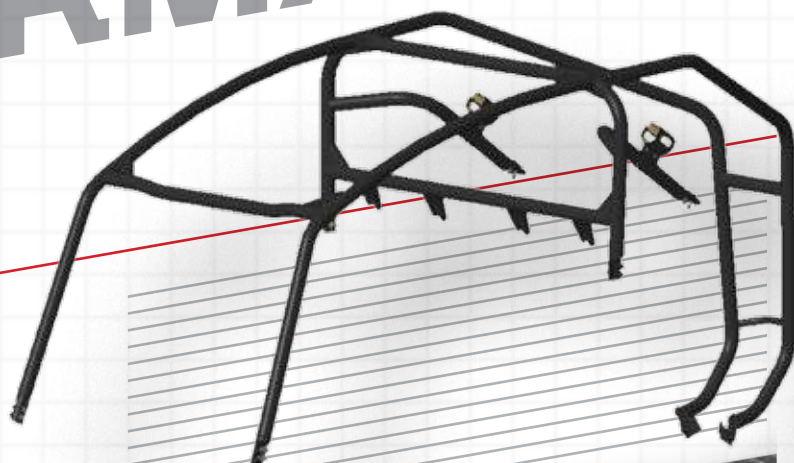

## TESTED

**THE POLARIS® TESTING PROCESS** is rigorous and unforgiving. We put every vehicle and accessory through extreme-use conditions both in the lab and in the field—in all environments, and in locations spanning the continent. If it doesn't pass our standards, it's not ready for your Polaris® vehicle. Only the best accessories make it to production.

## TRUSTED

**DEVELOPING THE BEST, MOST PREMIUM** accessories in the industry is our passion. Only Polaris® can combine decades of industry-leading experience, innovation and off-road expertise. Have confidence in your Polaris Engineered Accessories™, because we know the lifestyle and live it every day.

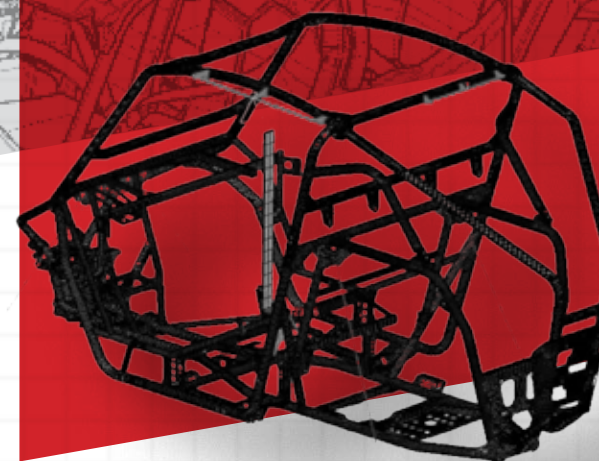

### POLARIS® PARTNERS WITH THE BEST

We choose our partners carefully, selecting only the best in off-road. Every accessory is rigorously tested and validated at Polaris® standards to ensure seamless integration and performance.



**PRO ARMOR**

WHEELS & TIRES p.32  
LIGHTING SOLUTIONS p.10

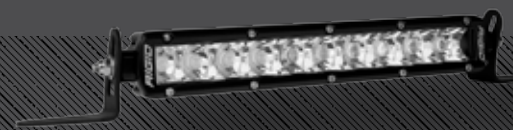

**RIGID**

LIGHTING SOLUTIONS p.10



**MBQUART**<sup>®</sup>

AUDIO COMPONENTS p.20



# SHOW

FACTORY COLOR-MATCHED PAINT

# &

PERFECT FIT & INSTALL

# SHINE



BUILD YOURS NOW, STARTING ON P.48

**POLARIS**<sup>®</sup>

ENGINEERED PARTS  
ACCESSORIES & APPAREL





TRAIL



DUNE

# CONQUER

A N Y E N V I R O N M E N T



MUD



DESERT



LIGHTING BY RIGID® | PRO ARMOR® | POLARIS®

LIGHT BARS P.12

LED HEADLIGHTS & ACCENTS P.16

PRO ARMOR® WHEELS & TIRES

TIRES P.36

WHEELS P.44

WHEEL & TIRE SETS P.46



# START YOUR BUILD



OFF-ROAD GRADE AUDIO BY MB QUART®

SYSTEM KITS P.26

HEAD UNITS & SPEAKERS P.24

RZR® FACTORY COLOR-MATCHED PAINT

ROOFS P.52

BUMPERS P.54

PROTECTION P.56

DOORS P.58

MIRRORS P.61



# FROM DUSK 'TIL DAWN

Every light bar from RIGID® and Pro Armor® is rigorously tested and validated by Polaris® standards to ensure seamless integration and performance. Extend your ride time and be more visible to others, with the brightest light bars in the industry. More than 20 options are available, making it easy to determine the right solution for your Polaris RZR®.

\*Accessory availability varies by market

## NEW RIGID LIGHT BARS

A trusted name in the off-road lighting industry, RIGID® delivers unmatched technology and superior performance.

## PRO ARMOR LIGHT BARS

Pro Armor® gives you sleek styling, rugged protection, and lighting solutions for your riding needs.

## POLARIS HEADLIGHTS AND ACCENTS

Replace your stock headlights, add more lumens to the trail, and keep the ride going into the night. The Trailblazer light features changeable custom-color bezels and LEDs that adjust from spot to flood for optimal light distribution.

CHOOSE LIGHTING BASED ON YOUR NEEDS

### STEP 1 CHOOSE SCENARIO/ANGLE

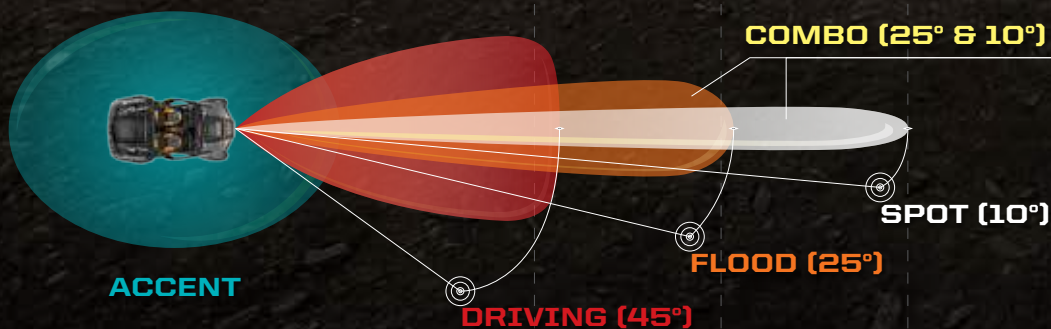
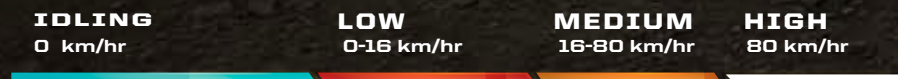

### STEP 2 CHOOSE OPTIC TYPES

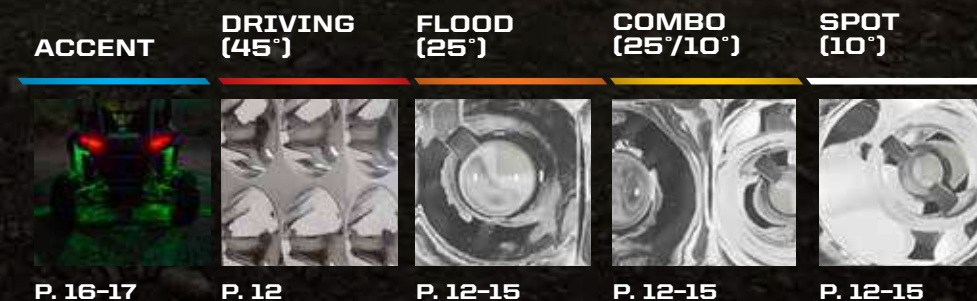

### STEP 3 CHOOSE HARNESSSES

1 LED LIGHT ON 1 SWITCH

» LED HARNESS • 2879859

2 LED LIGHTS ON 1 SWITCH

• Ideal for attaching two lights to bumper or roof

» LED LIGHT HARNESS 2879859

» Y-HARNESS 2879860



INTRODUCING

# RIGID®

## ADVANCED TECH

RIGID® lights are driven by Aluminum PCB Smart Boards™ with copper thermal conductive pads, gold-plated electrical contacts, 6063-T5 aircraft aluminum extruded housings treated with Alodine® corrosion preventive, and Tiger Drylac® UV protectant polyester powder coating.

## EXCLUSIVE OPTICS

RIGID® hand-selects the brightest high-tech LEDs from the best manufacturers. The LEDs shine through patented optics that maximize total light output and efficiency. RIGID® lights feature impact-resistant polycarbonate lenses for a 100% waterproof /dustproof seal.

## RIGID® LIMITED LIFETIME WARRANTY

If you own a RIGID® light and it breaks, we will replace or repair it for life.\*

## ADAPT™ **NEW**

The most advanced lighting solution on the market. Adjust the lighting pattern for your needs via the in-dash controller. As you change speed and terrain, you can dial in the light from spot to flood.

## D-SERIES PRO **NEW**

These lights produce extremely high output while consuming very little power. The compact size and shape allow the D-Series LED Light to fit almost anywhere and be used for virtually any lighting application.

## SR-SERIES PRO **NEW**

These single-row LED Light Bars provide a sleek, powerful, low-profile lighting solution that measures less than 5 cm tall. The SR-Series is designed to project light at extreme distances while consuming very little power. Available in a wide range of lengths and configurations.



## 8 BEAM PATTERNS

Select from 15 to 90 degrees—the pattern changes when and how you want.

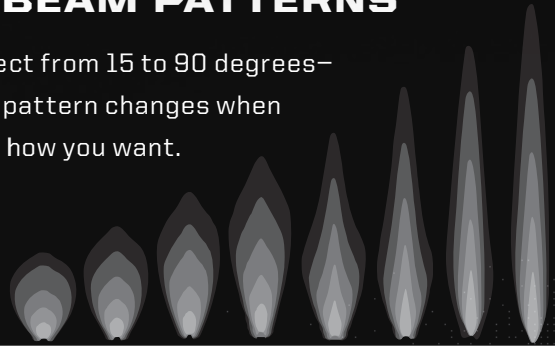

### BEAM ADAPTS TO ANY SITUATION

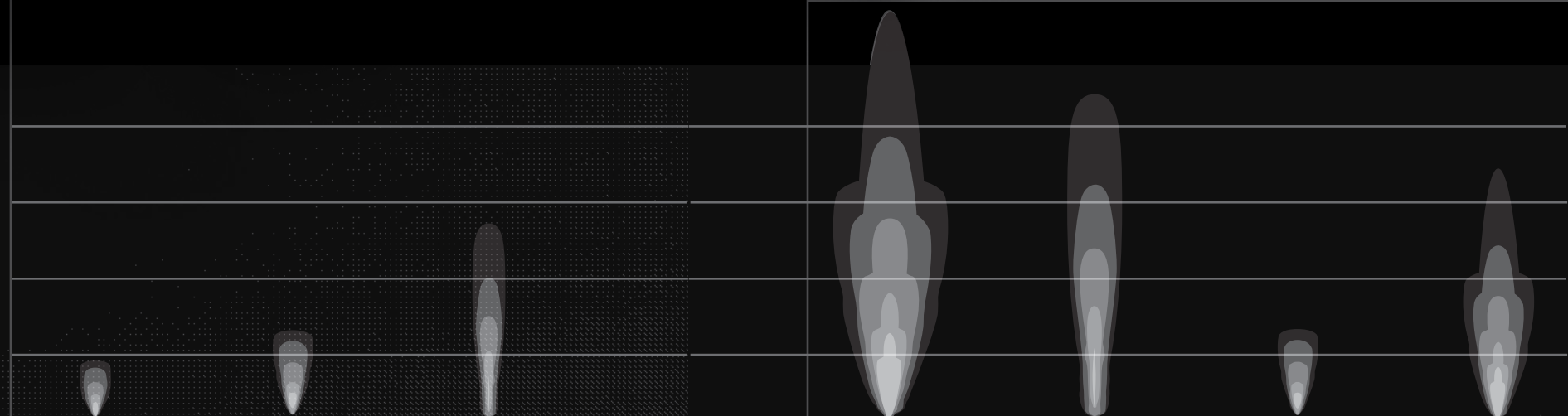

### MATCH YOUR STYLE

Choose from any color in the spectrum to reflect your style or current mood.

### CHANGE FROM THE DASH

A backlit, molded dash controller allows you to control the beam pattern and color.

### 10" ADAPT™

RAW LUMENS: 7,360

2883125

Available Fall 2017

### D-SERIES DRIVING

RAW LUMENS: 4,752

2883128

Comes in a pair

### D-SERIES FLOOD

RAW LUMENS: 3,168

2883126

Comes in a pair

### D-SERIES SPOT

RAW LUMENS: 3,168

2883127

Comes in a pair

### SR-SERIES 32" COMBO

RAW LUMENS: 20,064

2883124

### SR-SERIES 10" SPOT

RAW LUMENS: 7,920

2883121

### SR-SERIES 10" FLOOD

RAW LUMENS: 7,920

2883122

### SR-SERIES 10" COMBO

RAW LUMENS: 7,920

2883123

\* If RIGID® determines, in its sole discretion, that your product is defective in material or workmanship, RIGID® will honor your warranty claim. In some cases, the product will be replaced, depending on the specific timeframe of the purchase. If the product is repaired, all parts, labor, and return shipping may be covered by RIGID®.

SEE P. 11 FOR LIGHTING & BUSBAR HARNESSSES



# PRO ARMOR®



## RUGGED STYLING, DURABLE CONSTRUCTION

Pro Armor® lights are designed to be big and beefy with an aggressive style all their own. Housed in IP67 marine-grade rated UV Polyester powder-coated with precision-cast end panels and oversized, extruded aluminum heat sinks to keep the temperature down.

## EXCLUSIVE OPTICS

Counting up to 66 3-5 watt Cree® LEDs, Pro Armor® builds bright lights designed for any riding experience. All that power is directed through heat-dissipating aluminum printed circuit boards for streamlined heat management.

## DUAL-ROW LED LIGHT BARS

For the most spread and the farthest illumination downrange, Pro Armor® Dual-Row Light Bars are easy to mount and perform beyond expectations. Choose from several lengths and configurations.



## CUBE LIGHTS

Small and powerful, these cube lights can be mounted in strategic locations for added lighting.



## SINGLE-ROW LED LIGHT BARS

Powerful and compact, these low-profile light bars look sleek and let you light up the night. Choose from several lengths and configurations to extend your ride.

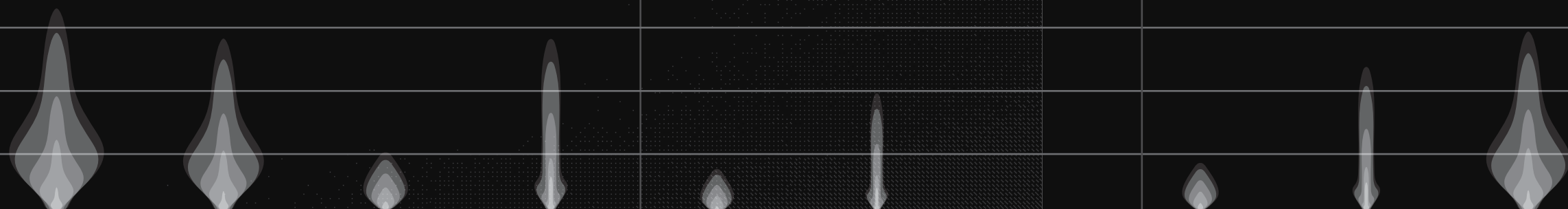

**NEW**

<b>DUAL-ROW 30" COMBO</b>	<b>DUAL-ROW 20" COMBO</b>	<b>DUAL-ROW 10" FLOOD</b>	<b>DUAL-ROW 10" SPOT</b>	<b>CUBE FLOOD</b>	<b>CUBE SPOT</b>	<b>SINGLE-ROW 11" FLOOD</b>	<b>SINGLE-ROW 11" SPOT</b>	<b>SINGLE-ROW 33" COMBO</b>
RAW LUMENS: 11,250	RAW LUMENS: 9,000	RAW LUMENS: 3,020	RAW LUMENS: 3,060	RAW LUMENS: 1,300	RAW LUMENS: 1,260	RAW LUMENS: 1,660	RAW LUMENS: 1,600	RAW LUMENS: 5,350
2882074	2883107	2882311	2882075	2882312	2882076	2882313	2882078	2882077
				SOLD INDIVIDUALLY	SOLD INDIVIDUALLY			

SEE P. 11 FOR LIGHTING & BUSBAR HARNESSES



**SHOWCASE YOUR STYLE**

Be a shining beacon of color when you ride at night. With our colorful line of LED accent lights and headlight bezels, you can stand out from the rest of the pack and create an iconic ride.



**ACCENT LIGHTS**

- Kit includes four LEDs and all harnessing/switching required. Single lights can be added to the kit (kit required)
- Durable off-road ready construction that is both dust and water resistant
- Control hub and complete instructions included

COLOR	LIGHTING KIT (4 LIGHTS)	SINGLE LIGHT
RED	2880500	2880532
BLUE	2880506	2880533
WHITE	2881119	2881176
GREEN	2882378	2882379

XP 4 1000/TURBO '14-18, XP 1000/TURBO '14-18, S 900 '15-18, 900 '15-18, 4 900 '15-18, S 1000 '16-18

**LED HEADLIGHT KIT**

- Replaces the stock headlights and provides brighter, more powerful lighting
- These lights use innovative angled reflectors instead of optics to cast a broader, brighter, more-effective light beam



» 2880485  
S 900 '15-18, 900 '15-18, 4 900 '15-18, S 1000 '16-18

# BLAZE YOUR TRAIL

WITH 6,000 LUMENS OF OPTICAL POWER



**TRAILBLAZER LED HEADLIGHTS**

- Direct replacement for factory headlight
- 6,000 lumen total output; 20-watt CREE® XHP LED Chips
- Durable construction is waterproof, dustproof, and fade resistant
- Adjustable beam pattern (outer two lights) allows for customized light patterns, from spot to flood, based on riding style and preference
- Integrated LED daytime running light
- Includes six black bezels

» BLACK BEZEL • 2882073  
XP 4 1000/TURBO '14-18, XP 1000/TURBO '14-18, S 900 '15-18, 900 '15-18, 4 900 '15-18, S 1000 '16-18

**CONTROL BEAM PATTERNS**

The Trailblazer LED headlight features adjustable beams on the inside and outside reflectors. Set the beam to your desired width or focus to dial in your beam pattern.

ADJUST

**MIX & MATCH COLOR BEZELS**



Personalize the look of your Trailblazer lights with interchangeable color-matched bezels. Choose from a variety of colors, or mix and match.

COLOR	2-PACK
RED	2882479-293
BLUE	2882479-689
WHITE	2882479-133
RAW	2882479





**POLARIS**  
**RIDECOMMAND**<sup>®</sup>

REVOLUTIONIZING  
THE OFF-ROAD EXPERIENCE



**POLARIS<sup>®</sup> 4.3" INTERACTIVE DISPLAY** TOP SELLER

- Backup camera (2881653) & forward camera (2882381) available (both sold separately).
- Exporting capabilities for creating tracks and Waypoints from the display to USB drive, GPS
- Connectivity offers exact location information
- Distance to a selected Waypoint shown on the map screen
- Automatic day/night screen brightness
- Bluetooth<sup>®</sup> connectivity for smartphone, text messages, battery life, & signal strength
- Diagnostics screen displays vehicle fault codes

» 2881554

XP 4 1000/TURBO '14-18, XP 1000/TURBO '14-18, 900 XC '15-17, S 900 '15-18, 900 '15-18, 4 900 '15-18, S 1000 '16-18. Requires Polaris<sup>®</sup> Interactive Digital Display Install Kit (2880497).

**POLARIS<sup>®</sup> 4.3" INTERACTIVE DISPLAY INSTALL KIT**



» 2880497

XP 4 1000/TURBO '14-18, XP 1000/TURBO '14-18, 900 XC '15-17, S 900 '15-18, 900 '15-18, 4 900 '15-18, S 1000 '16-18. This is required for installing the Polaris<sup>®</sup> Interactive Digital Display (2881554).



**KEEP TRACK OF YOUR FRIENDS ON THE TRAIL**



**HOLD A CONVERSATION WITHOUT HAVING TO SHOUT**



**MONITOR YOUR PHONE WHILE KEEPING IT STOWED**



**CONTROL YOUR GoPro<sup>®</sup> REMOTELY**



**TOTAL CONTROL RIGHT AT YOUR FINGERTIPS**



**SHARE YOUR RIDE WITH YOUR FRIENDS**

**RIDE COMMAND<sup>®</sup> 7" DISPLAY**

- Everything you need at the touch of your finger
- Displays fuel level, coolant temp, battery voltage
- KM/HR - RPM
- Trip 1 / Trip 2
- Buddy Tracking
- Full GPS capability (w/GPS puck)
- Save tracks/trails (import/export) via USB or Bluetooth
- AM & FM tuner
- Preset station & genre
- Front and rear (IR-Lit) cameras (sold separately)
- GoPro<sup>®</sup> integration
- Missed call/text message icons
- Cell phone battery life icon
- Cell phone signal strength

» 2882900

XP 4 1000/TURBO '14-18, XP 1000/TURBO '14-18, 900 XC '15-17, S 900 '15-18, 900 '15-18, 4 900 '15-18, S 1000 '16-18

**RIDE COMMAND<sup>®</sup> 7" DISPLAY MOUNT** NEW

- Mount your 7" touchscreen to RZR<sup>®</sup>
- Replaces dash for seamless fit and finish
- Includes front and rear cameras with mounts
- Comes with wiring harnesses needed for RZR<sup>®</sup> and accessory components, including all audio adapter harnesses

» 2883114

XP 4 1000/TURBO '14-18, XP 1000/TURBO '14-18, 900 XC '15-17, S 900 '15-18, 900 '15-18, 4 900 '15-18, S 1000 '16-18



**COMLINK RTX INTERCOM RADIO**

- Two person intercom with built-in two-way radio
- One unit for compact easy use
- No FCC license required to communicate with other VHF radios
- Great radio range of up to 5 miles
- Intercom expandable: up to 8 positions
- Easily connect your phone or MP3 player to receive calls or listen to music

» 2881319

XP 4 1000/TURBO '14-18, XP 1000/TURBO '14-18, 900 XC '15-17, S 900 '15-18, 900 '15-18, 4 900 '15-18, S 1000 '16-18

**COMLINK IN-HELMET HEADSET**

- Ride and talk with your helmet on
- Headset mounts inside your helmet and works with the Comlink RTX Radio

» 2881550

XP 4 1000/TURBO '14-18, XP 1000/TURBO '14-18, 900 XC '15-17, S 900 '15-18, 900 '15-18, 4 900 '15-18, S 1000 '16-18

**COMLINK RTX MOUNTING KIT**

- Seamlessly integrate your Comlink RTX into your RZR<sup>®</sup>
- Easily mounts inside Din Box area

» 2881320

XP 4 1000/TURBO '14-18, XP 1000/TURBO '14-18, 900 XC '15-17, S 900 '15-18, 900 '15-18, 4 900 '15-18, S 1000 '16-18

**4-PASS INTERCOM UPGRADE KIT**

- Add your rear seat passengers to the conversation

» 2882016

XP 4 1000/TURBO '14-18, 4 900 '15-18

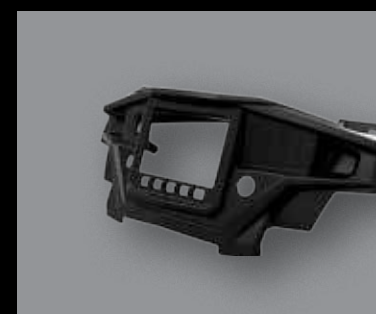



# OFF-ROAD GRADE AUDIO

When you research audio solutions for your Polaris RZR®, you'll see manufacturers bragging about how their audio equipment is "Marine Grade". Or worse yet, you'll discover for yourself that they are repackaged components built for automotive applications. MB Quart®, combined with Polaris®, engineers Off-Road Grade Audio equipment that's proven to deliver the loudest, crispest sound in the harshest conditions. Rain, snow, mud, heat, cold, dust—  
**ANY PLACE YOUR RZR® EXCELS, SO WILL YOUR AUDIO.**



RAIN

SNOW

MUD

SAND



# SURROUNDED BY SOUND

POLARIS® AND MB QUART® partner to bring you an audio experience that is powerful and comprehensive. A full offering of solutions if available for your ultimate RZR® audio build. Choose from loud to louder. Each component is designed and engineered to enhance your surround sound experience while surviving the harshest environments.

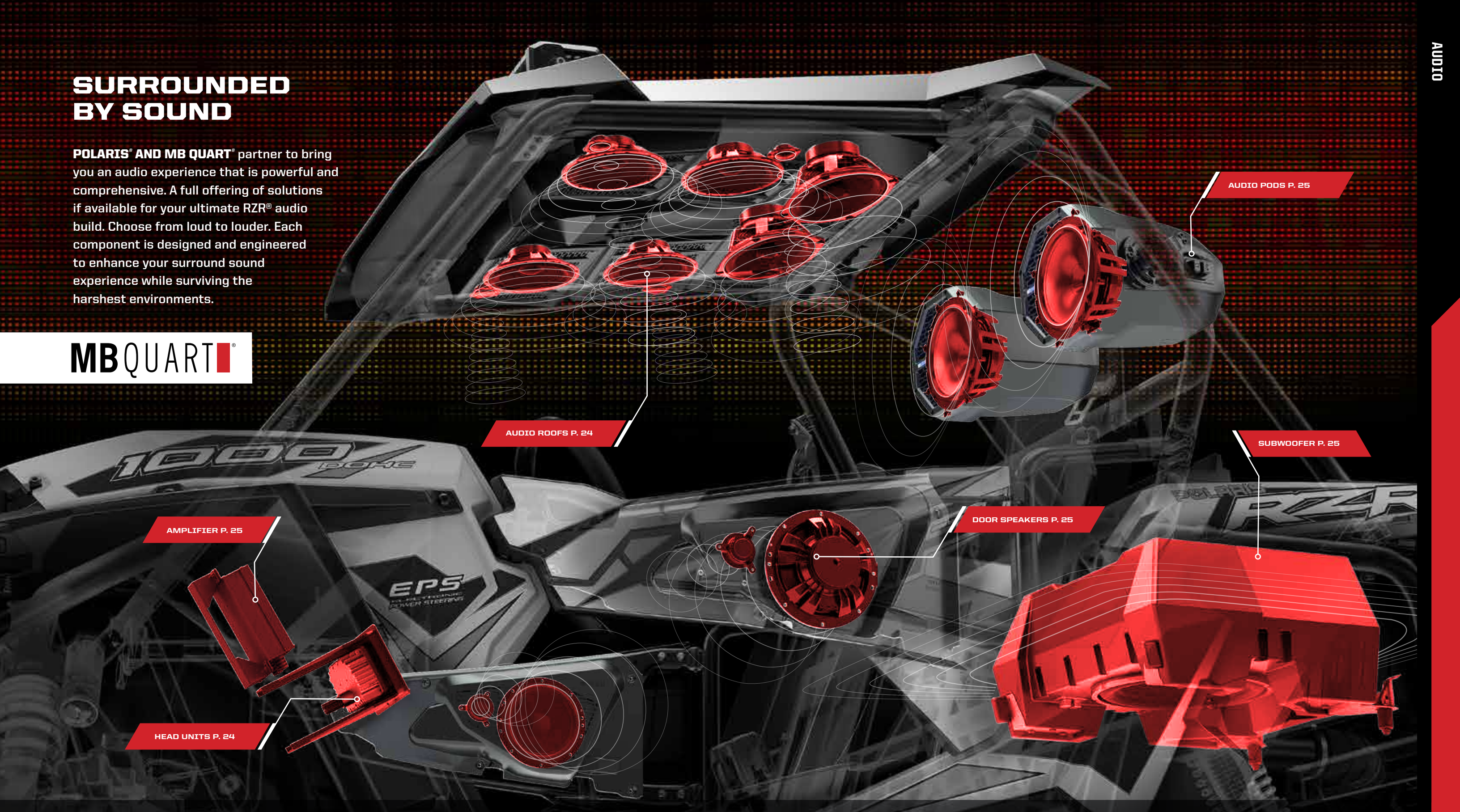

**BUILD YOUR SYSTEM**

**1 SELECT YOUR HEAD UNIT P. 24**

**2 CHOOSE YOUR SPEAKERS P. 25**

**3 FIND YOUR SYSTEM KIT P. 26**



# HEAD UNITS + SPEAKERS

These solutions get you well on your way to hitting the trails with your favorite tunes. Each feature head-units, allowing you to control audio delivery. Both audio roofs and sound bars are all-in-one solutions that can serve as the base of an expanded system with more speakers.

## AUDIO ROOFS

Add a Premium Audio Roof to your RZR® and get an all-in-one solution for your sound. Easy to install and integrate into your build, this roof comes complete with an LED push-button stereo and high-efficiency 6.5" (16.5 cm) coaxial speakers for unbeatable sound.

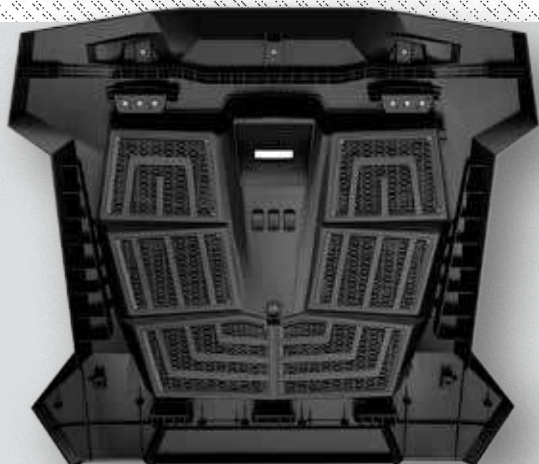

### S4 AUDIO ROOF

» 2882064  
XP 1000/TURBO '14-18, 900 XC '15-17, S 900 '15-18, 900 '15-18, S 1000 '16-18

### S8 AUDIO ROOF

» 2882065  
XP 1000/TURBO '14-18, 900 XC '15-17, S 900 '15-18, 900 '15-18, S 1000 '16-18

### S10 AUDIO ROOF

» 2882066  
XP 1000/TURBO '14-18, 900 XC '15-17, S 900 '15-18, 900 '15-18, S 1000 '16-18

MODEL:	S4	S8	S10
BUILT-IN STEREO W/ BLUETOOTH®, AM/FM RADIO AND AUX	✗	✗	✗
MODULAR DESIGN FOR IMPROVED SERVICEABILITY AND ACCESS	✗	✗	✗
(4) 6.5" (16.5 CM) COAXIAL SPEAKERS	✗	✗	✗
(4) 6.5" (16.5 CM) COMPONENT SPEAKERS MIDS & TWEETERS		✗	✗
(2) 6" X 9" (15.2 CM X 22.9 CM) COAXIAL SPEAKERS			✗
4-CHANNEL 2-OHM 300W AMPLIFIER		✗	✗
33" (84 CM) SINGLE-ROW PRO ARMOR® LIGHT BAR		✗	
30" (76 CM) DUAL-ROW PRO ARMOR® LIGHT BAR			✗
DOME LIGHT		✗	✗

# SPEAKERS

Build your dream audio system. From a simple setup with only door speakers, to complex system with door speakers, audio pods and a subwoofer—BUILD IT YOUR WAY.

## EXTREME AUDIO PODS

- Two 8" (20.3 cm) coaxial speakers with 1" (2.5 cm) titanium tweeters in weatherproof enclosures
- Self-amplified 200-watt per speaker output

» 2881227  
XP 4 1000/TURBO '14-18, XP 1000/TURBO '14-18, 900 XC '15-17, S 900 '15-18, 900 '15-18, 4 900 '15-18, S 1000 '16-18. Requires audio harness (2882167), see p. 27.



### EXTREME AUDIO POD MOUNTING BAR

» 2881473  
XP 4 1000/TURBO '14-18, XP 1000/TURBO '14-18, 900 XC '15-17, S 900 '15-18, 900 '15-18, 4 900 '15-18, S 1000 '16-18



### SOUND BAR 8

- Six mid-range/mid-bass speakers and two dedicated tweeters
- Waterproof speakers and controls
- Integrated, self-powered amplifier for easy installation
- Large, easy-to-use external controls

» 2881465  
ALL RZR® MODELS  
Speaker Bar Harness (2882280) required, see right. Busbar Harness required, See p. 27

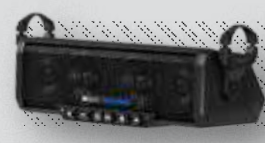

### SOUND BAR 4

- Two mid-range/mid-bass speaker and two dedicated tweeters

» 2881230  
ALL RZR® MODELS  
Speaker Bar Harness (2882280) required, see right. Busbar Harness required, See p. 27



### SPEAKER BAR HARNESS

- Power connection for soundbars
- Used to connect soundbar to accessory busbar for power

» 2882280  
Busbar Harness required, see p. 27



## 12" (20.3 CM) MAXBOOST SUBWOOFER

- High strength molded enclosure for optimal acoustics and superior fit
- Lock & Ride® connectivity to cargo bed
- Integrated 250-watt Class D amplifier
- Deep bass 12" (20.3 cm) subwoofer with 2" (5 cm) voice coil
- Wiring harness included

» 2882063  
XP 4 1000/TURBO '14-18, XP 1000/TURBO '14-18, 900 XC '15-17, S 900 '15-18, 900 '15-18, 4 900 '15-18, S 1000 '16-18

# HEAD UNITS

A head unit controls all aspects of your sound system. It lets you choose what you want to hear, when you want to hear it, and how loud you want the audio output.

## DASH RADIO

- A seamlessly integrated source unit to control all your audio needs
- Remote mounted USB / 3.5mm plug for external device connection
- Easy installation and great fit and finish
- Bluetooth® connectivity



» 2881988  
XP 4 1000/TURBO '14-18, XP 1000/TURBO '14-18, 900 XC '15-17, S 900 '15-18, 900 '15-18, 4 900 '15-18, S 1000 '16-18

## RADIAL BLUETOOTH® REMOTE **NEW**

- Keep your phone stowed away and play your favorite tunes through your RZR®
- Includes two (2) audio outputs for easy addition of audio components
- Bluetooth® 4.0 connectivity
- 3.5mm AUX jack for direct connection to music source
- Mount in an any open switch panel. Control music via the easy to use joystick. Turn the dial for volume control and toggle left/right or up/down for track selection. Push dial for power and pause/play



» 2883113  
XP 4 1000/TURBO '14-18, XP 1000/TURBO '14-18, 900 XC '15-17, S 900 '15-18, 900 '15-18, 4 900 '15-18, S 1000 '16-18

## DOOR SPEAKERS

- High performance 6.5" (16.5 cm) component speakers with 1.9 cm titanium dome tweeters
- Works with Polaris® lower door kits or Polaris® aluminum door kits
- Requires Audio Amplifier (2882122)
- Harnessing included to connect to audio amplifier

» FRONT • 2881989  
XP 4 1000/TURBO '14-18, XP 1000/TURBO '14-18, 900 XC '15-17, S 900 '15-18, 4 900 '15-18, S 1000 '16-18

» REAR (4-SEAT ONLY) 2883116  
XP 4 1000/TURBO '14-18, 4 900 '15-18. Requires Front Door Speakers (2881989)

Connects directly to 2882122 audio amplifier. No additional amplifier needed. Harnessing included.

## AUDIO AMPLIFIER

- This amplifier is a 200-watt TDA-based full-range Class D amplifier with fixed connections for power, ground and turn-on and Delphi connectors for door speakers

» 2882122  
XP 4 1000/TURBO '14-18, XP 1000/TURBO '14-18, 900 XC '15-17, S 900 '15-18, 900 '15-18, 4 900 '15-18, S 1000 '16-18





# SYSTEM KITS

## HEAD UNIT: AUDIO ROOFS



### S4 AUDIO ROOF

The RZR® Audio Roof S4 delivers a factory look but with the benefit of a 160-watt, AM/FM Bluetooth® stereo system with four 6.5-inch (16.5 cm) coaxial speakers designed and manufactured by MB Quart.

### S8 AUDIO ROOF

When your ride demands sound and lights, the RZR® Audio Roof S8-L is the best choice. This step-up system delivers a factory-look roof with more power.

### S10 AUDIO ROOF

Take a seat under more sound and more lights. The RZR® Audio Roof S10-L is the top of the line choice for audio and LED lighting integrated into a RZR® roof. This top-tier system delivers a factory-look roof with more power in a 300 watt, AM/FM Bluetooth® system with ten MB Quart speakers and includes an 11,250-Lumen LED Lightbar.



LOUDEST



LOUD

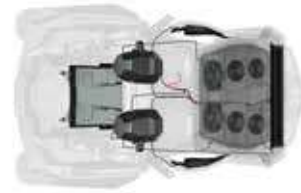

#### HEAD UNIT

- 2882064 S4 Audio Roof
- 2882065 S8 Audio Roof
- 2882066 S10 Audio Roof

#### SPEAKERS



- 2881989 Door Speakers
- 2882122 Audio Amp
- 2881227 Extreme Audio Pods
- 2882063 12" (30.5 cm) Subwoofer

#### HARNESSES

- 2882167 Rear Audio Harness
- 2883269 Y-Audio Harness
- 2881652 Line Out Audio Harness

- S4 ROOF TOTAL
- S8 ROOF TOTAL
- S10 ROOF TOTAL



#### HEAD UNIT

- 2882064 S4 Audio Roof
- 2882065 S8 Audio Roof
- 2882066 S10 Audio Roof

#### SPEAKERS



- 2881989 Door Speakers
- 2882122 Audio Amp
- 2882063 12" (30.5 cm) Subwoofer

#### HARNESSES

- 2883269 Y-Audio Harness
- 2881652 Line Out Audio Harness

- S4 ROOF TOTAL
- S8 ROOF TOTAL
- S10 ROOF TOTAL

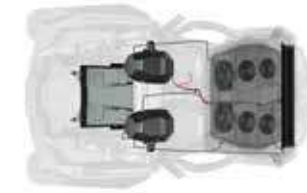

#### HEAD UNIT

- 2882064 S4 Audio Roof
- 2882065 S8 Audio Roof
- 2882066 S10 Audio Roof

#### SPEAKERS



- 2881227 Extreme Audio Pods
- 2882063 12" (30.5 cm) Subwoofer

#### HARNESSES

- 2882167 Rear Audio Harness
- 2883269 Y-Audio Harness

- S4 ROOF TOTAL
- S8 ROOF TOTAL
- S10 ROOF TOTAL

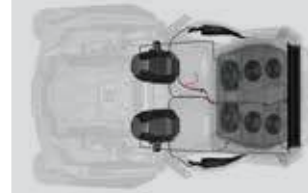

#### HEAD UNIT

- 2882064 S4 Audio Roof
- 2882065 S8 Audio Roof
- 2882066 S10 Audio Roof

#### SPEAKERS



- 2881989 Door Speakers
- 2882122 Audio Amp
- 2881227 Extreme Audio Pods

#### HARNESSES

- 2882167 Rear Audio Harness
- 2883269 Y-Audio Harness
- 2881652 Line Out Audio Harness

- S4 ROOF TOTAL
- S8 ROOF TOTAL
- S10 ROOF TOTAL

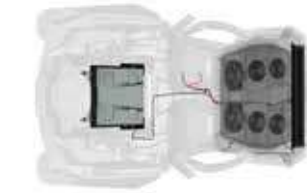

#### HEAD UNIT

- 2882064 S4 Audio Roof
- 2882065 S8 Audio Roof
- 2882066 S10 Audio Roof

#### SPEAKERS



- 2882063 12" (30.5 cm) Subwoofer

#### HARNESSES

No additional harnesses required

- S4 ROOF TOTAL
- S8 ROOF TOTAL
- S10 ROOF TOTAL

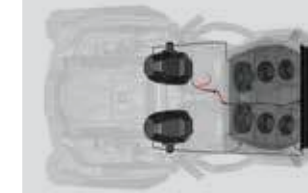

#### HEAD UNIT

- 2882064 S4 Audio Roof
- 2882065 S8 Audio Roof
- 2882066 S10 Audio Roof

#### SPEAKERS



- 2881227 Extreme Audio Pods

#### HARNESSES

- 2882167 Rear Audio Harness

- S4 ROOF TOTAL
- S8 ROOF TOTAL
- S10 ROOF TOTAL



#### HEAD UNIT

- 2882064 S4 Audio Roof
- 2882065 S8 Audio Roof
- 2882066 S10 Audio Roof

#### SPEAKERS



- 2881989 Door Speakers
- 2882122 Audio Amp

#### HARNESSES

- 2881652 Line Out Audio Harness

- S4 ROOF TOTAL
- S8 ROOF TOTAL
- S10 ROOF TOTAL

### BUSBAR HARNESS

Depending on your vehicle model, you may need to add a busbar harness and audio harnesses specific to your vehicle.

VEHICLE FITMENT	PART/PRICE
XP TURBO '17-18, XP 1000 '18	Harness not required, included on machine
XP TURBO '16, XP 1000 '16-17, S 1000 '16-18, 900/S 900 '16-18, 900 XC '16-17	2881551
XP 1000 '14-15, 900/S 900/900 XC '15	2882862
XP 4 TURBO '16, XP 4 1000 '16-17, 4 900 '16-18	2881646
XP 4 1000 '14-15, 4 900 '14-15	2882861

### Y-AUDIO HARNESS

• Y-Harness splits the audio signal and turn-on wire to allow for additional audio components to be added

» 2883269

### REAR AUDIO HARNESS

• Harness designed to connect audio components mounted on the rear of the vehicle. Contains power connection as well as audio (JST and remote on) connections. Required for audio pods

» 2882167

### LINE OUT AUDIO HARNESS

• Harness designed to extend JST audio signal. Use to run JST audio signal from rear of audio roof(s) to the front of the vehicle

» 2881652



# SYSTEM KITS

## HEAD UNIT: DASH RADIO



- A SEAMLESSLY INTEGRATED SOURCE UNIT TO CONTROL ALL YOUR AUDIO NEEDS

- BLUETOOTH® CONNECTIVITY
- EASY INSTALLATION AND GREAT FIT AND FINISH

- REMOTE-MOUNTED USB / 3.5MM PLUG FOR EXTERNAL DEVICE CONNECTION



LOUDEST

▶ LOUD

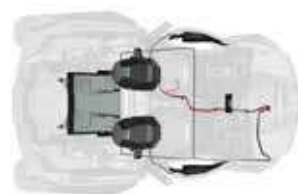

### HEAD UNIT

2881988 Dash Radio

### SPEAKERS



2881989 Door Speakers  
2883116 Rear Door Speakers (4-seat only)  
2882122 Audio Amp  
2881227 Extreme Audio Pods  
2882063 12" (30.5 cm) Subwoofer

### HARNESSES

2882167 Rear Audio Harness  
2883269 Y-Audio Harness (x2)

**2-SEAT TOTAL:**  
**4-SEAT TOTAL:**

BUSBAR HARNESS MAY BE REQUIRED, SEE OPPOSITE PAGE

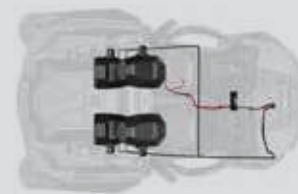

### HEAD UNIT

2881988 Dash Radio

### SPEAKERS

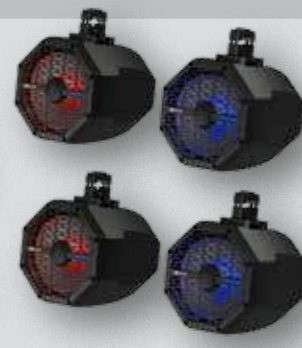

2881227 Extreme Audio Pods  
2881227 Extreme Audio Pods

### HARNESSES

2882167 Rear Audio Harness (x2)  
2883269 Y-Audio Harness

**TOTAL:**  
FITS 2-AND 4-SEAT MODELS

BUSBAR HARNESS MAY BE REQUIRED, SEE OPPOSITE PAGE



### HEAD UNIT

2881988 Dash Radio

### SPEAKERS



2881989 Door Speakers  
2883116 Rear Door Speakers (4-seat only)  
2882122 Audio Amp  
2882063 12" (30.5 cm) Subwoofer

### HARNESSES

2881651 Y-Audio Harness

**2-SEAT TOTAL:**  
**4-SEAT TOTAL:**

BUSBAR HARNESS MAY BE REQUIRED, SEE OPPOSITE PAGE

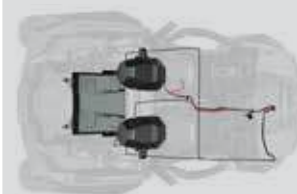

### HEAD UNIT

2881988 Dash Radio

### SPEAKERS



2881227 Extreme Audio Pods  
2882063 12" (30.5 cm) Subwoofer

### HARNESSES

2882167 Rear Audio Harness  
2883269 Y-Audio Harness

**TOTAL:**  
FITS 2-AND 4-SEAT MODELS

BUSBAR HARNESS MAY BE REQUIRED, SEE OPPOSITE PAGE



### HEAD UNIT

2881988 Dash Radio

### SPEAKERS



2881989 Door Speakers  
2883116 Rear Door Speakers (4-seat only)  
2882122 Audio Amp  
2881227 Extreme Audio Pods

### HARNESSES

2882167 Rear Audio Harness  
2883269 Y-Audio Harness

**2-SEAT TOTAL:**  
**4-SEAT TOTAL:**

BUSBAR HARNESS MAY BE REQUIRED, SEE ABOVE

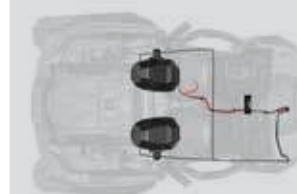

### HEAD UNIT

2881988 Dash Radio

### SPEAKERS



2881227 Extreme Audio Pods

### HARNESSES

2882167 Rear Audio Harness

**TOTAL:**  
FITS 2-AND 4-SEAT MODELS

BUSBAR HARNESS MAY BE REQUIRED, SEE ABOVE



### HEAD UNIT

2881988 Dash Radio

### SPEAKERS



2881989 Door Speakers  
2883116 Rear Door Speakers (4-seat only)  
2882122 Audio Amp

### HARNESSES

INCLUDED WITH SPEAKER KIT

**2-SEAT TOTAL:**  
**4-SEAT TOTAL:**

BUSBAR HARNESS MAY BE REQUIRED, SEE ABOVE

### BUSBAR HARNESS

Depending on your vehicle model, you may need to add a busbar harness and audio harnesses specific to your vehicle.

VEHICLE FITMENT	PART/PRICE
XP TURBO '17-18, XP 1000 '18	Harness not required, included on machine
XP TURBO '16, XP 1000 '16-17, S 1000 '16-18, 900/S 900 '16-18, 900 XC '16-17	2881551
XP 1000 '14-15, 900/S 900/900 XC '15	2882862
XP 4 TURBO '16, XP 4 1000 '16-17, 4 900 '16-18	2881646
XP 4 1000 '14-15, 4 900 '14-15	2882861

### Y-AUDIO HARNESS



- Y-Harness splits the audio signal to allow for additional audio components to be added

» 2883269

### REAR AUDIO HARNESS



- Harness designed to connect audio components mounted on the rear of the vehicle. Contains power connection as well as audio (JST and remote on) connections. Required for audio pods
- Works on 4-seat

» 2882167



# SYSTEM KITS

## HEAD UNIT: RADIAL BLUETOOTH® REMOTE



- KEEP YOUR PHONE STOWED AWAY AND PLAY YOUR FAVORITE TUNES

- MOUNT IN AN ANY OPEN SWITCH PANEL.

- CONTROL MUSIC VIA THE EASY TO USE JOYSTICK.

- TURN THE DIAL FOR VOLUME CONTROL AND TOGGLE LEFT/RIGHT OR UP/DOWN FOR TRACK SELECTION.

- PUSH DIAL FOR POWER AND PAUSE/PLAY

- BLUETOOTH® 4.0 CONNECTIVITY
- 3.5MM AUX JACK FOR DIRECT CONNECTION TO MUSIC SOURCE



LOUDEST



LOUD

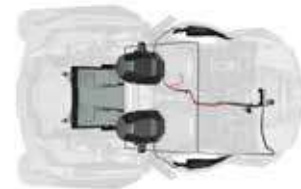

### HEAD UNIT

2883113 Radial Bluetooth® Remote

### SPEAKERS



2881989 Door Speakers  
2883116 Rear Door Speakers (4-seat only)  
2882122 Audio Amp  
2881227 Extreme Audio Pods  
2882063 12" (30.5 cm) Subwoofer

### HARNESSES

2882167 Rear Audio Harness  
2883269 Y-Audio Harness

**2-SEAT TOTAL:**  
**4-SEAT TOTAL:**

BUSBAR HARNESS MAY BE REQUIRED, SEE OPPOSITE PAGE

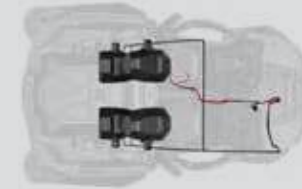

### HEAD UNIT

2883113 Radial Bluetooth® Remote

### SPEAKERS

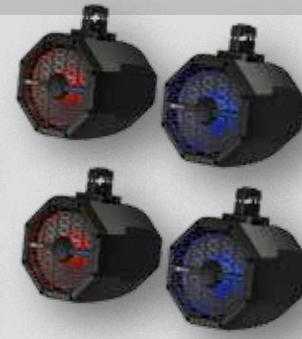

2881227 Extreme Audio Pods

### HARNESSES

2882167 Rear Audio Harness (2) each

**TOTAL:**  
FITS 2-AND 4-SEAT MODELS

BUSBAR HARNESS MAY BE REQUIRED, SEE OPPOSITE PAGE



### HEAD UNIT

2883113 Radial Bluetooth® Remote

### SPEAKERS



2881989 Door Speakers  
2883116 Rear Door Speakers (4-seat only)  
2882122 Audio Amp  
2882063 12" (30.5 cm) Subwoofer

### HARNESSES

No harness required

**2-SEAT TOTAL:**  
**4-SEAT TOTAL:**

BUSBAR HARNESS MAY BE REQUIRED, SEE OPPOSITE PAGE

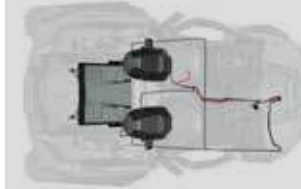

### HEAD UNIT

2883113 Radial Bluetooth® Remote

### SPEAKERS



2881227 Extreme Audio Pods  
2882063 12" (30.5 cm) Subwoofer

### HARNESSES

2882167 Rear Audio Harness

**TOTAL:**  
FITS 2-AND 4-SEAT MODELS

BUSBAR HARNESS MAY BE REQUIRED, SEE OPPOSITE PAGE

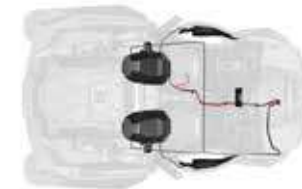

### HEAD UNIT

2883113 Radial Bluetooth® Remote

### SPEAKERS



2881989 Door Speakers  
2883116 Rear Door Speakers (4-seat only)  
2882122 Audio Amp  
2881227 Extreme Audio Pods

### HARNESSES

2882167 Rear Audio Harness

**2-SEAT TOTAL:**  
**4-SEAT TOTAL:**

BUSBAR HARNESS MAY BE REQUIRED, SEE ABOVE

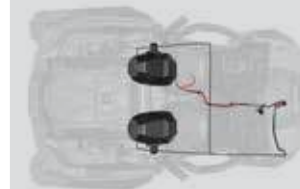

### HEAD UNIT

2883113 Radial Bluetooth® Remote

### SPEAKERS



2881227 Extreme Audio Pods

### HARNESSES

2882167 Rear Audio Harness

**TOTAL:**  
FITS 2-AND 4-SEAT MODELS

BUSBAR HARNESS MAY BE REQUIRED, SEE ABOVE



### HEAD UNIT

2883113 Radial Bluetooth® Remote

### SPEAKERS



2881989 Door Speakers  
2883116 Rear Door Speakers (4-seat only)  
2882122 Audio Amp

### HARNESSES

Included with Speaker Kit

**2-SEAT TOTAL:**  
**4-SEAT TOTAL:**

BUSBAR HARNESS MAY BE REQUIRED, SEE ABOVE

### BUSBAR HARNESS

Depending on your vehicle model, you may need to add a busbar harness and audio harnesses specific to your vehicle.

VEHICLE FITMENT	PART/PRICE
XP TURBO '17-18, XP 1000 '18	Harness not required, included on machine
XP TURBO '16, XP 1000 '16-17, S 1000 '16-18, 900/S 900 '16-18, 900 XC '16	2881551
XP 1000 '14-15, 900/S 900/900 XC '15	2882862
XP 4 TURBO '16, XP 4 1000 '16-17, 4 900 '16-18	2881646
XP 4 1000 '14-15, 4 900 '14-15	2882861

### Y-AUDIO HARNESS



• Y-Harness splits the audio signal to allow for additional audio components to be added  
» 2883269

### REAR AUDIO HARNESS



• Harness designed to connect audio components mounted on the rear of the vehicle. Contains power connection as well as audio (JST and remote on) connections. Recommended for audio pods  
• Works on 4-seat  
» 2882167



# PRO ARMOR®



## CONQUER ANY TERRAIN WITH PRO ARMOR® TIRES.

As an industry leader in premium off-road accessories for more than a decade, Pro Armor® delivers purpose-built tires with superior durability and ultimate performance for the environment you ride. Developed and tested with Polaris® engineers—ensuring the perfect fit and optimal performance mile after mile.



## 2 WAYS TO PURCHASE

INDIVIDUAL WHEELS & TIRES (pp. 36-45) - OR - COMPLETE SETS (p. 46)

DOMINATE ANY ENVIRONMENT

CHECK OUT THE FOLLOWING PAGES TO FIND YOURS

### TRAIL

### DUNE

### DESERT

### MUD

PG. 36

PG. 38

PG. 40

PG. 42



# PRO ARMOR®



# TIRES

Polaris® and Pro Armor® developed a deep partnership thanks to having similar histories and a passion for producing products that enhance vehicle performance. Each wheel and tire Pro Armor® designs and engineers for Polaris® off-road vehicles performs perfectly in the intended environment for its intended use. Developed, tested, and produced in partnership so you can tackle the terrain ahead.



## 10-PLY

Pro Armor® builds the toughest tires to keep you running when the terrain turns tough. A higher ply rating means added protection. Choose your tire and ply rating based on use and overall performance needs.

## DUAL COMPOUNDS

You don't ride or drive in just one type of terrain, so Pro Armor® builds certain tires with multiple wear zones. A dual-durometer design allows the tire to wear better with softer outer lugs and harder inner lugs.

## TRIPLE-BELTED SIDEWALLS

Sidewalls can be a vulnerable area of any off-road tire. Rocks jump out at your machine and tear into sidewalls. Thanks to reinforced construction in this critical area, Pro Armor® resists damage.

## TORTURE-TESTED TOUGH SIDEWALLS

Most tire makers only test puncture resistance in the tread and along the bead. In the toughest terrains you're more likely to puncture the sidewall. Pro Armor® builds its tires with triple-belted sidewalls, minimizing the chance of a puncture in that area.

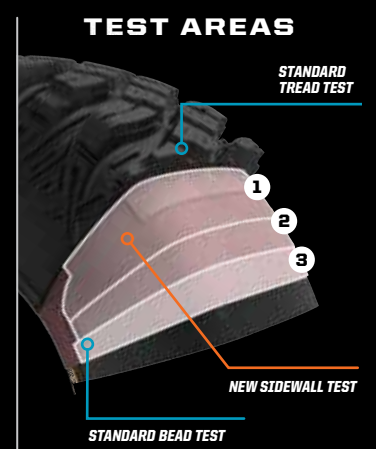

# 4,828 KM RATED

Pile on the miles with Pro Armor® tires. Every tire is designed and constructed with longevity in mind. With ratings of 4,828 kilometers and beyond, you are assured long life and performance.

TIRE: **DUAL-THREAT**

WHEEL: **BUCKLE ACCENT**

### KNOW YOUR TIRES

**DIMENSIONS**  
28" x 9" R14  
TIRE HEIGHT | TIRE WIDTH | WHEEL DIAMETER

**TREAD DEPTH**  
A deeper tread means more grip and cleaner performance

**WEIGHT**  
A lighter tire makes for improved vehicle performance

**PLY RATING**  
Indicates the overall load capability of the tire

**SIDEWALL BELTS**  
Sidewall belts increase your resistance to sidewall punctures

**LOAD RATING**  
Tires with higher load ratings can handle more weight

**PADDLE DEPTH**  
Increases grip and performance in the sand





# TRAIL



## PRO ARMOR® ATTACK 2.0 **NEW**

Engineered for excellent hard-pack performance

- 15" 30" x 10" R15 • FRONT/REAR 5416345
- 15" 28" x 10" R15 • FRONT/REAR 5416344

### FEATURES

- Dual-compound technology and radial construction offers performance in all terrains.
- Radial construction

### TREAD PATTERN



	TREAD DEPTH	TIRE WEIGHT	PLY RATING	SIDEWALL BELTS	LOAD RATING
28R15	25mm	14.5 kg	10	3	504 kg
30R15		17 kg			560 kg



WHEEL SIZE

15"



## DUAL-COMPOUND = MORE GRIP

Dual-compound tires feature both a softer durometer rubber on the outer edge of the tire, and a harder durometer rubber in the middle. This gives the tire the perfect balance between high-speed performance with durability and excellent flex in order to grip slick rock or hard pack.



## PRO ARMOR® DUAL-THREAT **NEW**

Dual-compound technology and radial construction offers performance in all terrains

### FEATURES

- Softer durometer rubber on outer edge for overall superior grip and feel
- Harder durometer rubber in the middle for increased traction during acceleration and longer tread life

### TREAD PATTERN



- 14" 29" x 11" R14 • REAR 5416343
- 14" 26" x 11" R14 • REAR 5416341
- 14" 29" x 9" R14 • FRONT 5416342
- 14" 26" x 9" R14 • FRONT 5416340

	TREAD DEPTH	TIRE WEIGHT	PLY RATING	SIDEWALL BELTS	LOAD RATING
26R14	16mm	FRONT 12 kg	10	3	413 kg
		REAR 14 kg			504 kg
29R14	16mm	FRONT 14 kg	10	3	504 kg
		REAR 16 kg			599 kg

FRONT

REAR



WHEEL SIZE

14"



## PRO ARMOR® ATTACK

The best all-purpose tire for all-season traction in any terrain

- 14" 26" x 9" R14 • FRONT • 5415613
- 14" 26" x 11" R14 • REAR • 5415614

### FEATURES

- Unique, full-face tread design
- Harder durometer lugs promote extended wear, increasing tire life
- Wider spaced lugs provide more grip in softer terrain

### TREAD PATTERN



WHEEL SIZE

14"

	TREAD DEPTH	TIRE WEIGHT	PLY RATING	SIDEWALL BELTS	LOAD RATING
FRONT	23mm	13 kg	8	3	413 kg
REAR		14.5 kg			599 kg



## PRO ARMOR® HAMMER

Tame the roughest trail and high desert conditions with this multi-terrain tire

- 15" 30" x 9.5" R15 • FRONT/REAR 5415615

### FEATURES

- High-durometer compound withstands high temperatures and abusive environments

### TREAD PATTERN



WHEEL SIZE

15"

TREAD DEPTH	WEIGHT	PLY RATING	SIDEWALL BELTS	LOAD RATING
20mm	16 kg	8	3	599 kg





# SAND



## PRO ARMOR® DUNES

28" flotation across the dunes

- 14" 28" x 9" R14 • FRONT • 5415533
- 14" 28" x 11" R14 • REAR • 5415534

### FEATURES

- Lightweight 12-paddle rear tires tout a flexible sidewall for flotation and acceleration
- 3-tiered front tire design delivers hard-turning bite and straight-line tracking

	TREAD DEPTH	TIRE WEIGHT	PLY RATING	SIDEWALL BELTS	LOAD RATING
FRONT	12.8mm	9 kg	8	2	288 kg
REAR	31mm	9 kg			438 kg



## PRO ARMOR® SAND

30" and 16 paddles optimized to carve up the biggest dunes

- 14" 30" x 11" R14 • FRONT • 5415251
- 14" 30" x 14" R14 • REAR • 5415252

### FEATURES

- 16 paddles directly deliver the HP to the sand for high-performance dune riding
- Unique 3-tiered front tire design delivers hard-turning bite and straight-line tracking
- Lightweight and flexible sidewalls ensure full contact with the sand in the rear

	TREAD DEPTH	TIRE WEIGHT	PLY RATING	SIDEWALL BELTS	LOAD RATING
FRONT	12.8mm	14 kg	8	2	547 kg
REAR	31mm	12 kg	4		499 kg

FRONT

REAR

12 PADDLES

FRONT

REAR

16 PADDLES

WHEEL SIZE

14"

WHEEL SIZE

14"





# RACE

# ROCK



## PRO ARMOR® CRAWLER XR

### FEATURES

Wanna race? This tire grips it all from the trail to the rocks

**15"** 32" x 10" R15 • FRONT/REAR  
5416114

**14"** 28" x 10" R14 • FRONT/REAR  
5415536

- Square block profile for even surface contact
- A tougher durometer than the XG to take on the toughest the trail has to offer

### TREAD PATTERN

TREAD DEPTH	TIRE WEIGHT	PLY RATING	SIDEWALL BELTS	LOAD RATING
28" R14	<b>15 kg</b>	<b>8</b>	<b>3</b>	<b>517 kg</b>
32" R15	<b>18 kg</b>			<b>608 kg</b>



### WHEEL SIZES

↑ 14"  
↓ 15"



## PRO ARMOR® CRAWLER XG

### FEATURES

Big or small, these tires crawl them all

**NEW** **15"** 30" x 10" R15 • FRONT/REAR  
5416397

**14"** 32" x 10" R14 • FRONT/REAR  
5416113

**NEW** **15"** 28" x 10" R15 • FRONT/REAR  
5416346

**14"** 30" x 10" R14 • FRONT/REAR  
5415616

- A soft, sticky compound makes this tire ideal for both rock crawling and desert running
- 8-ply, triple-belted ballistic sidewalls resist punctures

### TREAD PATTERN

TREAD DEPTH	TIRE WEIGHT	PLY RATING	SIDEWALL BELTS	LOAD RATING
28" R15	<b>14.5 kg</b>	<b>8</b>	<b>3</b>	<b>517 kg</b>
30" R14	<b>18 kg</b>			<b>581 kg</b>
30" R15	<b>18.1 kg</b>			<b>581 kg</b>
32" R14	<b>19.1 kg</b>			<b>644 kg</b>

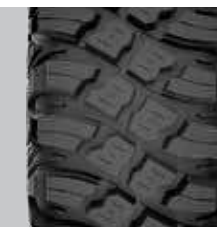

### WHEEL SIZES

↑ 14"  
↓ 15"

## SHORT LUG, SINGLE DUROMETER

Smaller lug height and single durometer gives this high-speed tire added rigidity and lateral stability when cornering. Its unique lug design excels in hard-packed, fast terrain.

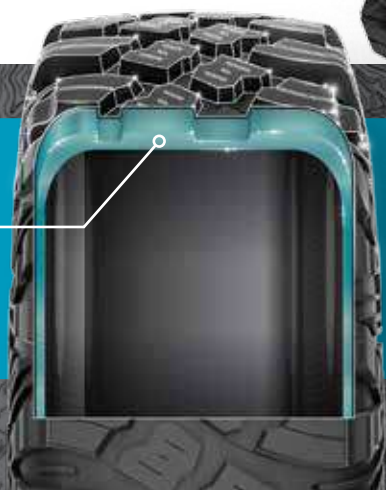

## TALL LUG, DUAL-DUROMETER

With its taller lug height and dual-durometer construction, this tire has the perfect balance between high-speed performance, durability and flex in order to grip slick rock.







# MUD



## PRO ARMOR® ANARCHY

Take on any mud pit with the Mud Master

**14"** 29.5" x 9" R14 • FRONT/REAR • 5415535

### FEATURES

- Ultra deep lugs for maximum mud traction
- Deep, evenly spaced out lugs help channel the muck out so you can keep going

### TREAD PATTERN



WHEEL SIZE

14"

TREAD DEPTH	TIRE WEIGHT	PLY RATING	SIDEWALL BELTS	LOAD RATING
52mm	18 kg	8	3	531 kg



# SNOW



## PRO ARMOR® DAGGER

From the trails to the pits, this tire gets you through it all

**14"** 27" x 9" R14 • FRONT • 5415617  
**14"** 27" x 11" R14 • REAR • 5415618

### FEATURES

- Deep, self-cleaning lug and wide tire design for exceptional mud pit performance
- Rounded profile and full lug pattern for on-trail comfort

### TREAD PATTERN



WHEEL SIZE

14"

	TREAD DEPTH	TIRE WEIGHT	PLY RATING	SIDEWALL BELTS	LOAD RATING
FRONT	38mm	14.5 kg	8	3	499 kg
REAR		18.1 kg			531 kg



## PRO ARMOR® WHITEOUT

Extra wide tires for flotation in snow

**15"** 30" x 15" R15 • FRONT/REAR • 5416395

### FEATURES

- Cross-hatched tread pattern designed for superior snow traction with limited digging
- 2-ply sidewall designed to balloon for maximum use of its 15" wide contact patch

### TREAD PATTERN

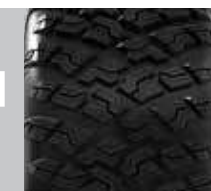

WHEEL SIZE

15"

TREAD DEPTH	TIRE WEIGHT	PLY RATING	SIDEWALL BELTS	LOAD RATING
17mm	18.6 kg	2	2	531 kg

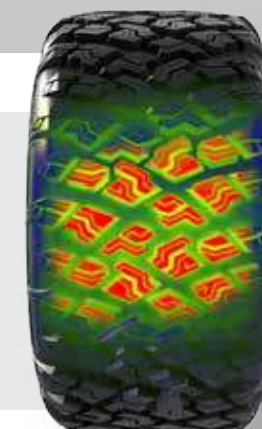

### MORE SURFACE AREA FOR BETTER FLOTATION ON SNOW

Snow-specific tire for trails and deep powder. Features an extra wide, bias-ply construction that can run at low pressures for maximum flexibility. High-flotation performance maintains critical vehicle ground clearance in the snow.





## 14" WHEELS

- AMPLIFY**
- A. ACCENT: FRONT 14" x 7" • 1522956-266  
REAR 14" x 8" • 1522957-266
  - B. MATTE BLACK: FRONT 14" x 7" • 1522956-458  
REAR 14" x 8" • 1522957-458
- BUCKLE**
- C. ACCENT: FRONT 14" x 7" • 1522544-266  
REAR 14" x 8" • 1522545-266
  - D. MATTE BLACK: FRONT 14" x 7" • 1522544-458  
REAR 14" x 8" • 1522545-458

- COMBAT *NEW*** (BEADLOCK RINGS INCLUDED)
- E. ACCENT: FRONT & REAR 14" x 7" • 1523284
  - F. MATTE BLACK: FRONT & REAR 14" x 7" • 1523283
- REBLR** (BEADLOCK RINGS SOLD SEPARATELY)
- G. MATTE BLACK: FRONT 14" x 7" • 1522238-458  
REAR 14" x 8" • 1522239-458
- SHACKLE**
- H. ACCENT: FRONT 14" x 7" • 1522546-266  
REAR 14" x 8" • 1522547-266
  - I. MATTE BLACK: FRONT 14" x 7" • 1522546-458  
REAR 14" x 8" • 1522547-458

- SIX'R**
- J. MATTE BLACK: FRONT 14" x 7" • 1521507-521  
REAR 14" x 8" • 1521508-521
  - K. LUSTER: FRONT 14" x 7" • 1521507-410  
REAR 14" x 8" • 1521508-410
- SPLIT**
- L. MATTE BLACK: FRONT 14" x 6" • 1522542-458  
REAR 14" x 8" • 1522543-458

## 15" WHEELS

- CYCLONE *NEW***
- M. ACCENT: FRONT & REAR 15" x 7" • 1523184-266
  - N. MATTE BLACK: FRONT & REAR 15" x 7" • 1523184-458
- HALO *NEW*** (BEADLOCK RINGS INCLUDED)
- O. ACCENT: FRONT & REAR 14" x 7" • 1523282
  - P. MATTE BLACK: FRONT & REAR 14" x 7" • 1523286

- WHITEOUT**
- Q. MATTE BLACK: FRONT & REAR 15" x 10" • 1523149-458
- WYDE** (BEADLOCK RINGS SOLD SEPARATELY)
- R. ACCENT: FRONT & REAR 15" x 7" • 1522550-266
  - S. MATTE BLACK: FRONT & REAR 15" x 7" • 1522550-458
- HEXLR** (BEADLOCK RINGS SOLD SEPARATELY)
- T. ACCENT: FRONT & REAR 15" x 7" • 1522435-458

## BEADLOCKS

- FORGED BEADLOCK RINGS**
- VOODOO BLUE: 14" • 1522244-619  
15" • 1522240-619
  - MACHINED: 14" • 1522244-266  
15" • 1522240-266
  - WHITE: 14" • 1522244-133  
15" • 1522240-133
  - INDY RED: 14" • 1522244-293  
15" • 1522240-293
  - ORANGE CRUSH: 14" • 1522244-589  
15" • 1522240-589
  - HALO/COMBAT REPLACEMENT (MATTE BLACK): 1523146-458  
1523147-458



# WHEEL & TIRE SETS

These wheel and tire sets by Pro Armor® are paired to deliver maximum performance for your RZR®. The chart lists all possible combinations that work together and each of the vehicles on which they fit. Choose your preferred tire along the top, and pair it with your preferred wheel on the side. The corresponding square lists the part number for a complete four wheel & tire set.

# 14" SETS

TIRES	ANARCHY *RZR XP1000/ TURBO	ATTACK *ALL RZR	DAGGER *ALL RZR	DUAL THREAT 26"	DUAL THREAT 29"	DUNES *ALL RZR EXCEPT 570 & 50"	SAND *RZR XP1000/ TURBO	PRESERVE 27"	HARVESTER 27"	HARVESTER 28"	CRAWLER XR 28"	CRAWLER XG 32"	CRAWLER XG 30" *RZR XP1000/TURBO
AMPLIFY <i>Accent</i>	2882402	2882390	2882392	2883138	2883146	2882400	2882398	2883208	2882388	2883225	2882394	2882452	2882396
AMPLIFY <i>Matte Black</i>	2882403	2882391	2882393	2883139	2883147	2882401	2882399	2883209	2882388	2883226	2882395	2882451	2882397
BUCKLE <i>Accent</i>	2881341	2881335	2881337	2883140	2883148	2881345	2881339	2883203	2882383	2883220	2881343	2882448	2881560
BUCKLE <i>Matte Black</i>	2881342	2881336	2881338	2883141	2883149	2881346	2881340	2883204	2882384	2883221	2881344	2882447	2881561
COMBAT <i>Accent</i> *BEADLOCKS PRE- MOUNTED				2883217	2883219						2883213	2883215	2883210
COMBAT <i>Matte Black</i> *BEADLOCKS PRE- MOUNTED				2883216	2883218						2883212	2883214	2883211
REBLR <i>Matte Black</i> *BEADLOCKS SOLD SEPARATELY		2881381	2881383			2881387	2881384				2881386		2881382
SHACKLE <i>Accent</i>	2881353	2881347	2881349	2883142	2883150	2881357	2881351	2883205	2882385	2883222	2881355	2882450	2881558
SHACKLE <i>Matte Black</i>	2881354	2881348	2881350	2883143	2883151	2881358	2881352	2883206	2882386	2883223	2881356	2882449	2881559
SIXR <i>Luster</i>		2881359	2881362				2881365				2881371		2881564
SIXR <i>Matte Black</i>	2881369	2881360	2881363	2883144	2883152	2881375	2881366	2883207	2882387	2883224	2881372	2882453	2881563
SPLIT <i>Matte Black</i>		2881404	2881405	2883145	2883153	2881407	2881406						
THRASHER <i>Matte Black</i>	2881446	2881378	2881380										

# 15" SETS

TIRES	CRAWLER XG 30" *RZR XP1000/TURBO	ATTACK 2.0 28" *ALL RZR EXCEPT 570 & 50"	ATTACK 2.0 30" *RZR XP1000/TURBO	CRAWLER XG 28" *ALL RZR EXCEPT 570 & 50"	CRAWLER XR 32" *RZR XP1000/TURBO	HAMMER *RZR XP1000/TURBO	WHITEOUT 30" *RZR XP1000/TURBO
WHEELS							
CYCLONE <i>Accent</i>	2883179	2883180	2883169	2883188	2883194	2883200	
CYCLONE <i>Matte Black</i>	2883178	2883159	2883168	2883187	2883193	2883199	
FLARE <i>Accent</i>	2883177	2883158	2883167	2883186	2883192	2883198	
FLARE <i>Matte Black</i>	2883176	2883157	2883166	2883185	2883191	2883197	
HALO <i>Accent</i> *BEADLOCKS PRE- MOUNTED	2883181	2883162	2883171	2883190	2883196	2883202	
HALO <i>Matte Black</i> *BEADLOCKS PRE- MOUNTED	2883180	2883161	2883170	2883189	2883195	2883201	
HEXLR MATTE BLACK *BEADLOCKS SOLD SEPARATELY	2883173	2883154	2883163	2883182	2882444	2881388	
WYDE <i>Accent</i>	2883175	2883156	2883165	2883184	2882446	2881402	
WYDE <i>Matte Black</i>	2883174	2883155	2883164	2883183	2882445	2881403	
WHITEOUT R15 <i>Matte Black</i>							2883172

## LUGS

### 12MM X 1.5 SPLINED LUG NUTS

» 16 SPLINED LUG NUTS WITH WRENCH 2879332  
XP 1000/TURBO, 900

» 4 SPLINED LUG NUTS WITHOUT WRENCH 2879331  
XP 1000/TURBO, 900

» SPLINED LUG WRENCH 2204966  
XP 1000/TURBO, 900

### 3/8" - 24 HEX LUG NUTS

» 16 HEX LUG NUTS 2877409  
570

» 4 HEX LUG NUTS 2876754  
570



## REPLACEMENT CAPS



### POLARIS® CAPS

» LUSTER 1521509-410  
ALL WHEELS EXCEPT THRASHER, WYDE & HEXLR

» LUSTER 1522243-410  
THRASHER & HEXLR

» MATTE BLACK 1522243-458  
THRASHER & HEXLR

» MATTE BLACK 1521509-521  
ALL WHEELS EXCEPT THRASHER, WYDE & HEXLR



### PRO ARMOR® CAPS

» LUSTER 5453209-410  
ALL WHEELS EXCEPT THRASHER, WYDE & HEXLR

» LUSTER 1523015-410  
THRASHER & HEXLR

» MATTE BLACK 5453209-458  
ALL WHEELS EXCEPT THRASHER, WYDE & HEXLR

» MATTE BLACK 1523015-458  
THRASHER & HEXLR

» MATTE BLACK 1523063-458  
WYDE

## PERFORMANCE/CLEARANCE

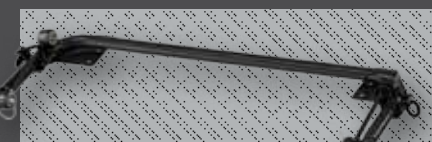

### FRONT SWAY BAR KIT

» 2881205-458

DOES NOT WORK WITH HIGH CLEARANCE A-ARMS



### HIGH-CLEARANCE A-ARM KIT

» 2880796-458

XP 4 1000/TURBO '14-18, XP 1000/TURBO '14-18

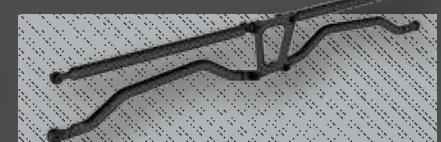

### HIGH-CLEARANCE RADIUS RODS

» 2879523-458

XP 1000/TURBO '14-16, XP 4 1000/TURBO '14-16  
2880560-XXX WILL FIT, 2879450-XXX WILL NOT FIT  
MY 17 RZR TURBO/1000 USE 12 MM BOLTS FOR THE RADIUS ROD AND MY16 BACK USE 10 MM, WILL NOT FIT ON MY17



## PREMIUM TIRE SEALANT

- Instantly seals and repairs rim, bead leaks, and punctures up to 6.4 mm on standard tires, and 19.2 mm on heavy ply tires
- Helps maintain air pressure for the life of the tire
- Helps seal the tire bead against the wheel
- 100% water soluble for easy cleanup.
- Will not rust, corrode, or pit wheels
- Creates permanent repair
- Remains fluid and effective in temperatures down to -43° C
- Easily installed through existing tire valve stem with valve core removed

- » 946 ML • 2830484
- » 3.8 LITER • 2830485
- » 19 LITER • 2830486

- » 19 LITER PUMP • 2830487
- » 208 LITER • 2830489
- » 1,041 LITER • 2830488

## VALVES

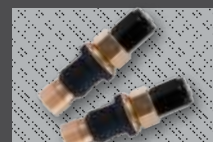

COLBY VALVE SHORT ULTIMATE VALVE (2 PACK) **NEW**

» 2883292



COLBY VALVE EMERGENCY VALVE (2 PACK) **NEW**

» 2883293



T H E P O W E R O F C O L O R

THE POWER OF COLOR

27

ROOFS  
PP. 52-53

LIME SQUEEZE



SPECTRA ORANGE



VELOCITY BLUE



INDY RED



WHITE



49

BUMPERS  
PP. 54-55



24

ROCK SLIDERS  
P. 57



08

DOOR GRAPHICS  
P. 58





# KEEP A LOW PROFILE

7.6 cm LOWER  
THAN STOCK CAGE



**NO MODIFICATIONS NEEDED FOR INSTALLATION.** Add a custom look that sets you apart from the crowd. This custom cage offers all the safety standards and accessory mounting locations you need, but with a completely new look for your RZR®. Add even more customization with a rear plate and a roof.

## BARRICADE CAGE SYSTEM WITH EXTENSION

» 2882558-458

### BARRICADE CAGE SYSTEM

■ BLACK 2881986-458

XP 1000/TURBO '14-18. Freight charges apply, see dealer for details

### BARRICADE CAGE EXTENSION

■ BLACK 2882171-458

XP 1000/TURBO '14-18. Works with 2881986-458

## FULL ROHVA COMPLIANCE

The Barricade Cage System meets ANSI/ROHVA 2016-1 ROPS standards, developed and tested by the Recreational Off-Highway Vehicle Association.

VISIT [ROHVA.ORG](http://ROHVA.ORG) FOR MORE INFORMATION.

## BARRICADE CAGE SYSTEM

- ROHVA-compliant, single-piece, fully-welded roll cage
- 7.6 cm lower profile than stock cage for true custom look
- High-quality powdercoat and E-coat finish
- Works with Polaris® Poly Half Windshield

■ BLACK 2881986-458  
XP 1000/TURBO '14-18

## BARRICADE CAGE SYSTEM - ROOF

- Protect yourself from the elements while adding style and color to your custom cage
- Easy installation with integrated fastening points
- High-quality powdercoated finish
- Lightweight aluminum

■ BLACK 2882172-458  
■ LIME SQUEEZE 2882172-630  
■ INDY RED 2882172-293  
■ VELOCITY BLUE 2882172-689  
■ BRIGHT WHITE 2882172-133

XP 1000/TURBO '14-18

## BARRICADE CAGE SYSTEM - EXTENSION

- High-quality powdercoat and E-coat finish
- Integrated tie-down bar
- Easy installation

■ BLACK 2882171-458  
XP 1000/TURBO '14-18

## BARRICADE CAGE SYSTEM - REAR PLATE

- Precision cut and formed from a rugged steel plate
- Attaches quickly and easily to integrated fastening points

■ BLACK 2882173-458  
■ LIME SQUEEZE 2882173-630  
■ INDY RED 2882173-293  
■ VELOCITY BLUE 2882173-689  
■ BRIGHT WHITE 2882173-133

XP 1000/TURBO '14-18





# ROOFS

**EVERY POLARIS® ROOF IS ENGINEERED IN TANDEM WITH YOUR RZR®** to guarantee the best fit, finish and style in the industry. A roof is essential for keeping the elements at bay while you ride your favorite trails in comfort.

## POLY

- LOCK & RIDE**
- POLY SPORT ROOF** **TOP SELLER**
- Rigid injection-molded design to eliminate warping in high-heat conditions
  - Integrated mounting locations for lighting
  - Rugged, textured polyethylene construction for impact and abrasion resistance
  - Aggressive styling to match the RZR® design

- GRAPHIC SPORT ROOF**
- Weighs only 5 kg (30% lighter than aluminum)
  - Easy installation
  - Won't bend or break upon impact with debris or other obstacles
  - Sun roof lets some sunlight through while keeping you shaded from the heat

## ALUMINUM

- ALUMINUM ROOF** **TOP SELLER**
- Give your RZR® a sharp look with this brushed aluminum roof
  - Seals to the vehicle frame for the best protection and great integration with other RZR® accessories
  - Strong and durable 5051 aluminum construction for long-lasting, reliable protection

## CANVAS

- CANVAS ROOF**
- Durable, heavyweight 652 grams polyester canvas construction
  - Mold-resistant and UV-stable to resist fading for long-lasting performance
  - Installs quickly and easily with provided straps

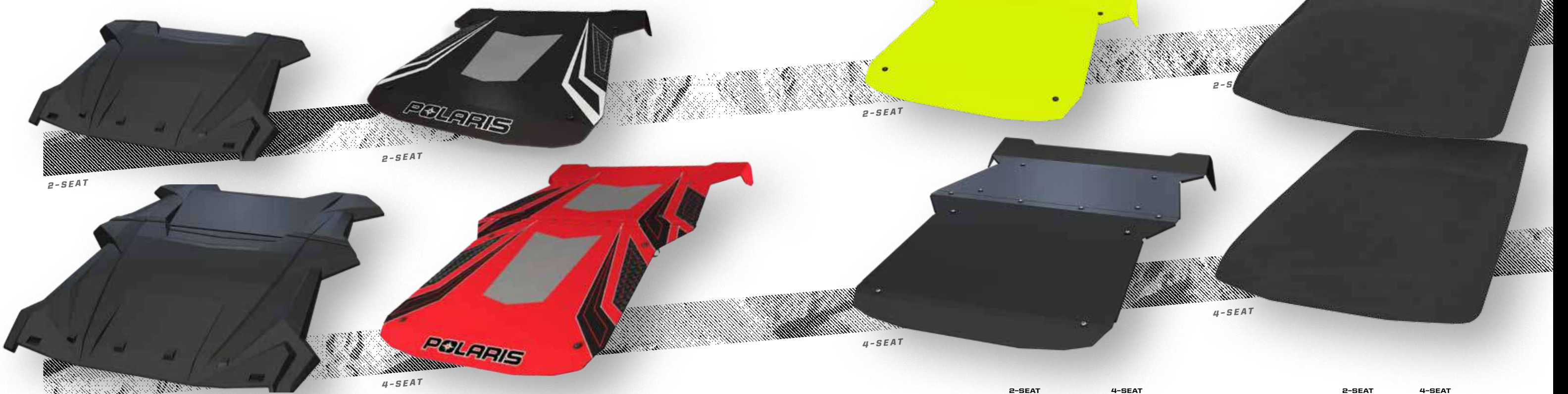

	2-SEAT	4-SEAT
■ BLACK	2883073	2883074

2-SEAT: XP 1000/TURBO '14-18, 900 XC '15-17, S 900 '15-18, 900 '15-18, S 1000 '16-18  
4-SEAT: XP 4 1000/TURBO '14-18, 4 900 '15-18

	2-SEAT	4-SEAT
■ BLACK	2881206	2881935
■ INDY RED	2881607	2881936
□ BRIGHT WHITE	2881608	2881937

2-SEAT: XP 1000/TURBO '14-18, 900 XC '15-17, S 900 '15-18, 900 '15-18, S 1000 '16-18  
4-SEAT: XP 4 1000/TURBO '14-18, 4 900 '15-18

	2-SEAT	4-SEAT
■ BLACK	2881582-458	2881592-458
■ LIME SQUEEZE	2881582-630	2881592-630
■ INDY RED	2881582-293	2881592-293
■ VELOCITY BLUE	2881582-689	2881592-689
■ SPECTRA ORANGE	2881582-446	2881592-446
□ BRIGHT WHITE	2881582-133	2881592-133

2-SEAT: XP 1000/TURBO '14-18, 900 XC '15-17, S 900 '15-18, 900 '15-18, S 1000 '16-18  
4-SEAT: XP 4 1000/TURBO '14-18, 4 900 '15-18

	2-SEAT	4-SEAT
■ BLACK	2880561	2880610

2-SEAT: 900 XC '15-17, S 900 '15-18, 900 '15-18, S 1000 '16-18  
4-SEAT: XP 4 1000/TURBO '14-18, 4 900 '15-18



# STAND GUARD

**ANCHOR MOUNTS**  
Tougher than conventional nuts and bolts, Expansion Anchor Mounts are engineered into every RZR, allowing for a fast install.

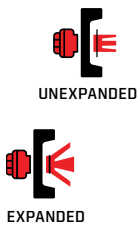

**BUMPER ANCHOR PACK**

- 4 anchors and 2 Bumper End Caps included
- » 2205114

## BULL BUMPERS

PERFECT FOR: **ULTRA LIGHT WEIGHT AND MINIMALIST LOOK**

FRONT



3.8 CM X 5.1 CM  
STEEL OVAL CONSTRUCTION



REAR

COLOR	FRONT	REAR
BLACK	2881202-458	2881472-458
LIME SQUEEZE	2881202-630	2881472-630
INDY RED	2881202-293	2881472-293
VELOCITY BLUE	2881202-689	2881472-689
SPECTRA ORANGE	2881202-446	2881472-446
BRIGHT WHITE	2881202-133	2881472-133

**FRONT FITMENTS**  
XP 4 1000/TURBO '14-18, XP 1000/TURBO '14-18, 900 XC '15-17, S 900 '15-18, 900 '15-18, 4 900 '15-18, S 1000 '16-18

**REAR FITMENTS**  
XP 4 1000/TURBO '14-18, XP 1000/TURBO '14-18

## LOW PROFILE BUMPERS TOP SELLER

PERFECT FOR: **MORE PROTECTION, INTEGRATED MOUNTING LOCATIONS FOR ACCESSORIES**

FRONT



4.4 CM DIAMETER  
STEEL TUBE CONSTRUCTION



REAR

COLOR	FRONT	REAR
BLACK	2879449-458	2880560-458
LIME SQUEEZE	2881583-630	2881589-630
INDY RED	2881583-293	2881589-293
VELOCITY BLUE	2881583-689	2881589-689
SPECTRA ORANGE	2881583-446	2881589-446
BRIGHT WHITE	2881583-133	2881589-133

**FRONT FITMENTS**  
XP 4 1000/TURBO '14-18, XP 1000/TURBO '14-18, 900 XC '15-17, S 900 '15-18, 900 '15-18, 4 900 '15-18, S 1000 '16-18

**REAR FITMENTS**  
XP 4 1000/TURBO '15-18, XP 1000/TURBO '15-18

## DELUXE BUMPERS TOP SELLER

PERFECT FOR: **MAXIMUM PROTECTION, INTEGRATED MOUNTING POINTS**

FRONT



3.8 CM DIAMETER  
STEEL TUBE CONSTRUCTION

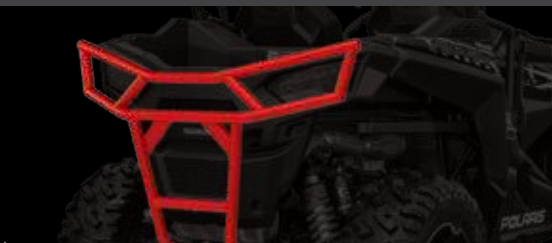

REAR

COLOR	FRONT	REAR
BLACK	2880166-458	2880164-458
LIME SQUEEZE	2881591-630	2881590-630
INDY RED	2881591-293	2881590-293
VELOCITY BLUE	2881591-689	2881590-689
SPECTRA ORANGE	2881591-446	2881590-446
BRIGHT WHITE	2881591-133	2881590-133

**FRONT FITMENTS**  
XP 4 1000/TURBO '14-18, XP 1000/TURBO '14-18, 900 XC '15-17, S 900 '15-18, 900 '15-18, 4 900 '15-18, S 1000 '16-18

**REAR FITMENTS**  
900 XC '15-17, S 900 '15-18, 900 '15-18, 4 900 '15-18, S 1000 '16-18

## EXTREME BUMPER ATTACHMENT

PERFECT FOR: **INCREASED PROTECTION AROUND LIGHTING AND FENDERS**

FRONT



REQUIRES:  
LOW PROFILE FRONT BUMPER (2879449-XXX, 2881583-XXX)

4.4 CM DIAMETER  
STEEL TUBE CONSTRUCTION

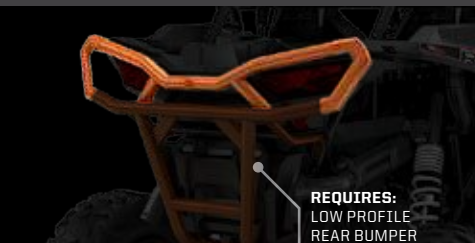

REAR

REQUIRES:  
LOW PROFILE REAR BUMPER (2880560-XXX, 2881589-XXX)

COLOR	FRONT	REAR
BLACK	2879451-458	2879452-458
LIME SQUEEZE	2881584-630	2881585-630
INDY RED	2881584-293	2881585-293
VELOCITY BLUE	2881584-689	2881585-689
SPECTRA ORANGE	2881584-446	2881585-446
BRIGHT WHITE	2881584-133	2881585-133

**FRONT FITMENTS**  
XP 4 1000/TURBO '14-18, XP 1000/TURBO '14-18, 900 XC '15-17, S 900 '15-18, 900 '15-18, 4 900 '15-18, S 1000 '16-18

Requires Low Profile Front Bumper (2879449-XXX, 2881583-XXX)

**REAR FITMENTS**  
XP 4 1000/TURBO '14-18, XP 1000/TURBO '14-18

Requires Low Profile Rear Bumper (2880560-XXX, 2881589-XXX)

## EXTREME DUTY BUMPER

PERFECT FOR: **FULL PROTECTION IN THE TOUGHEST TERRAIN AND RIDING CONDITIONS**

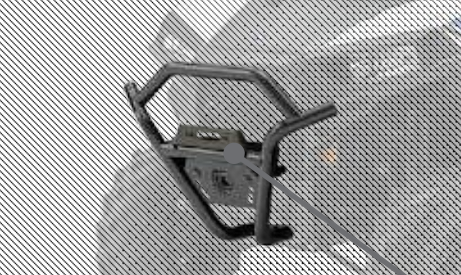

4.4 CM DIAMETER  
STEEL TUBE CONSTRUCTION



WINCH INSTALLS DIRECTLY TO BUMPER

COLOR	FRONT
BLACK	2880479-458

**FRONT FITMENTS**  
XP 4 1000/TURBO '14-18, XP 1000/TURBO '14-18, 900 XC '15-17, S 900 '15-18, 900 '15-18, 4 900 '15-18, S 1000 '16-18

Requires Low Profile Front Bumper (2879449-XXX, 2881583-XXX)

**REAR FITMENTS**  
XP 4 1000/TURBO '14-18, XP 1000/TURBO '14-18

ALL POLARIS ENGINEERED™ BUMPERS HAVE **BUILT-IN MOUNTING LOCATIONS** FOR LIGHTS. NO DRILLING NECESSARY.

### INTRUSION BAR

- » 2879181  
XP 4 1000/TURBO '14-18, XP 1000/TURBO '14-18, 900 XC '15-17, S 900 '15-18, 900 '15-18, 4 900 '15-18, S 1000 '16-18  
Will not work with any full windshield.

### BUMPER ADAPTER

• Connects the Upper Cab Frame Extension (2880411) with rear bumper, each sold separately

- » 2880165  
900 XC '15-17, S 900 '15-18, 900 '15-18, 4 900 '15-18, S 1000 '16-18

### REAR CAB FRAME EXTENSION

- » UPPER • 2880411  
900 XC '15-17, S 900 '15-18, 900 '15-18, S 1000 '16-18
- » LOWER • 2880412  
900 XC '15-17, S 900 '15-18, 900 '15-18, S 1000 '16-18



TOUGH .95 cm THICK  
DESIGN WITHSTANDS  
THE TOUGHEST IMPACTS

### HMW FRONT A-ARM GUARDS

- » 2879454  
XP 1000/TURBO '14-18,  
XP 4 1000/TURBO '14-18
- » 2880274  
S 1000 '16-18, 4 900 '15-18,  
S 900 '15-18, 900 XC 15-17
- » 2880170  
900 '15-18

### HMW REAR TRAILING ARM GUARDS

- » 2879496  
XP 1000/TURBO '14-18,  
XP 4 1000/TURBO '14-18

PROTECT YOUR RIDE

**WHEN PUSHING LIMITS**  
in punishing off-road  
environments, keep your  
RZR® protected from harsh  
hits and damage with an  
added layer of protection  
and peace of mind.

CUSTOM CONTOURED FOR A PERFECT  
FIT TO RETAIN MAXIMUM  
GROUND CLEARANCE

### HMW SKID PLATE

- » 2-SEAT • 2880290  
900 XC '15-17, S 900 '15-18,  
900 '15-18, 4 900 '15-18,  
S 1000 '16-18
- » 2-SEAT • 2881615  
XP 1000/TURBO '14-18
- » 4-SEAT • 2880291  
4 900 '15-18
- » 4-SEAT • 2881725  
XP 4 1000/TURBO '14-18

### REAR A-ARM GUARDS

- » 2880171  
900 XC '15-17, S 900 '15-18,  
4 900 '15-18, S 1000 '16-18
- » 2880172  
900 '14-18

## LOW PROFILE ROCK SLIDERS - STEEL

- Plate steel construction, durable powdercoat finish
- Easy installation with expanded anchor mount

2-SEAT



LOW PROFILE: NO LOSS IN GROUND CLEARANCE

4-SEAT

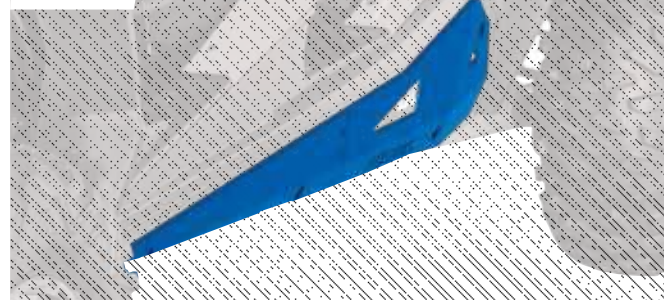

	2-SEAT	4-SEAT
■ BLACK	2879498-458	2879940-458
■ LIME SQUEEZE	2881587-630	2881593-630
■ INDY RED	2881587-293	2881593-293
■ VELOCITY BLUE	2881587-689	2881593-689
■ SPECTRA ORANGE	2881587-446	2881593-446
□ BRIGHT WHITE	2881587-133	2881593-133

2-SEAT  
XP 1000/TURBO '14-18, 900 XC '15-17, S 900 '15-18,  
900 '15-18, S 1000 '16-18  
4-SEAT  
XP 4 1000/TURBO '14-18, 4 900 '15-18



### XXL FENDER FLARES TOP SELLER (FRONT ONLY)

- Keep the mud, dirt, and debris from launching off the tires and into your face
- Includes 2

- » 2881985  
XP 4 1000/TURBO '14-18, XP 1000/TURBO '14-18,  
900 XC '15-17, S 900 '15-18, 900 '15-18, S 1000 '16-18

## EXTREME KICK-OUT ROCK SLIDERS - STEEL

- Rugged steel protection and race-inspired styling
- Low-profile mounting location will not diminish ground clearance

2-SEAT

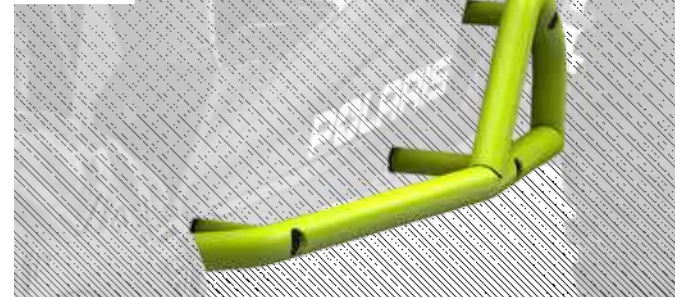

4.45 CM DIAMETER STEEL TUBE CONSTRUCTION

4-SEAT

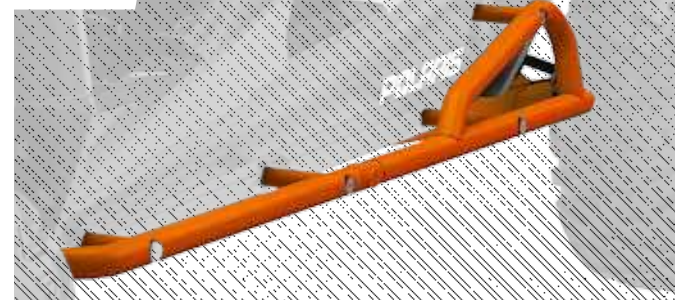

	2-SEAT	4-SEAT
■ BLACK	2879456-458	2882079-458
■ LIME SQUEEZE	2881586-630	2882079-630
■ INDY RED	2881586-293	2882079-293
■ VELOCITY BLUE	2881586-689	2882079-689
■ SPECTRA ORANGE	2881586-446	2882079-446
□ BRIGHT WHITE	2881586-133	2882079-133

2-SEAT  
XP 1000/TURBO '14-18, 900 XC '15-17, S 900 '15-18,  
900 '15-18, S 1000 '16-18  
4-SEAT  
XP 4 1000/TURBO '14-18, 4 900 '15-18

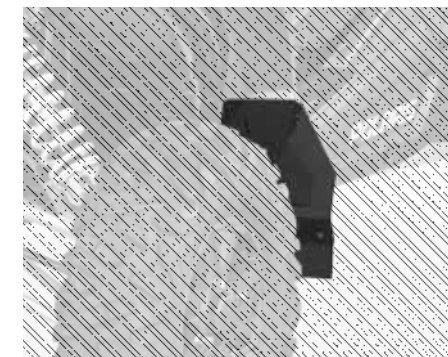

### MUDFLAPS (FRONT ONLY)

- Includes 2

- » 2879938  
XP 4 1000/TURBO '14-18, XP 1000/TURBO '14-18, 900 XC  
'15-18, S 900 '15-18, 4 900 '15-18, S 1000 '16-18

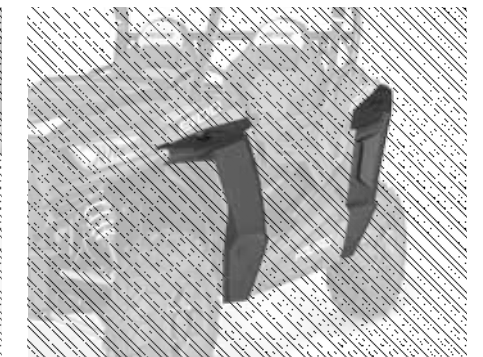

### FENDER FLARE KIT

- Stock replacement for 900 Models.
- Front & Rear Fender Flares (includes 4)

- » 2879434  
900 '15-18



# DOORS

## POLARIS® ALUMINUM DOORS

- Single-piece stamped aluminum maximizes quality, fit and finish
- More cockpit room with wide berth
- Gasket design eliminates rattling and creates a firm seal
- Available with RZR™-matched graphics

- » 2-SEAT • 2879510  
XP 1000/TURBO '14-18, S 900 '15-18, S 1000 '16-18, 900 XC '15-17
- » 4-SEAT • 2879943  
XP 4 1000/TURBO '14-18, 4 900 '14-18



### POLARIS® ALUMINUM DOOR GRAPHICS

	2-SEAT	4-SEAT
TITANIUM METALLIC	2882129	
WHITE LIGHTNING	2882127	2882128
TURBO CRUISER BLACK	2882126	2882125
TURBO TITANIUM	2882124	2882123
TURBO MATTE SUNSET RED	2882096	2882095
TURBO VELOCITY BLUE	2883129	2883118
BLACK PEARL	2883131	2883130
TURBO BLACK PEARL	2883134	

2-SEAT: XP 1000/TURBO '17-18; 4-SEAT: XP 4 1000/TURBO '17-18

**NEW**



TURBO MATTE SUNSET RED



TITANIUM METALLIC



WHITE LIGHTNING

**NEW**



TURBO VELOCITY BLUE

**NEW**



BLACK PEARL

**NEW**



TURBO BLACK PEARL



TURBO CRUISER BLACK



TURBO TITANIUM



### CANVAS UPPER HALF DOORS

- » 2-SEAT • 2879902  
XP 1000/TURBO '14-18, 900 XC '15-17, S 900 '15-18, S 1000 '16-18
- » 4-SEAT • 2879946  
XP 4 1000/TURBO '14-18, 4 900 '15-18



## LOWER DOOR INSERTS TOP SELLER

- Covers the bottom of the door opening, shutting out water and dust
- Durable plastic construction with steel frame

- » 2-SEAT 2879509 •  
XP 1000/TURBO '14-18, S 900 '15-18, S 1000 '16-18
- » 2-SEAT 2880207 •  
900 '15-18
- » 4-SEAT 2879942 •  
XP 4 1000/TURBO '14-18, 4 900 '15-18

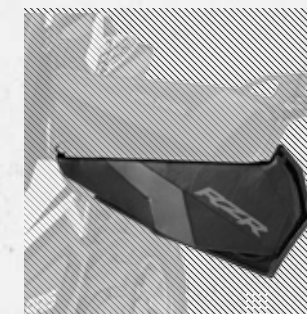

### LOWER DOOR LINERS

- » FRONT • 2879432  
900 '15-18. Works with Lower Door Inserts (2880207).
- » FRONT • 2879433  
XP 4 1000/TURBO '14-18, XP 1000/TURBO '14-18, 900 XC '15-17, S 900 '15-18, S 1000 '16-18. Works with Lower Door Inserts (2879509).
- » REAR • 2880704  
XP 4 1000/TURBO '14-18, 4 900 '15-18. Works with Lower Door Inserts (2879942).

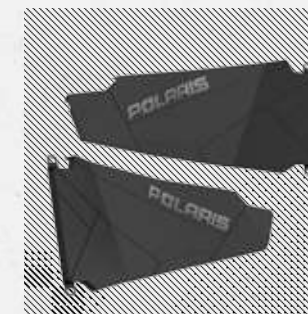

### UPPER DOOR LINERS

- » FRONT • 2879996  
900 '15-18
- » FRONT • 2879431  
XP 4 1000/TURBO '14-18, XP 1000/TURBO '14-18, 900 XC '15-17, S 900 '15-18, 4 900 '15-18, S 1000 '16-18
- » REAR • 2880703  
XP 4 1000/TURBO '14-18, 4 900 '15-18

### UPPER DOOR NETS

- » 2881654  
XP 1000/TURBO '14-18, 900 XC '15-17, S 900 '15-18, S 1000 '16-18. Does not fit 127 cm.







# WATCH.



LARGE 13 CM  
500NIT COLOR  
SCREEN

# RECORD.



1080p FRONT AND  
REAR VIDEO CAMERAS

# SHARE.



**TAKE YOUR REARVIEW MIRROR BEYOND** what you thought possible with this high-tech accessory. Record and share your ride, see what is behind you when backing up with the infrared night lighting.

## DVR MIRROR TOP SELLER

- Installs easily: mount bolts right into the ROPS of your vehicle
- Hard-mounted wide-angle front camera is adjustable to accommodate viewing height
- Neck-saving rear view camera keeps riders in view and assists when backing up
- Fully-functioning mirror with behind-glass display
- High-resolution screen is easy to see in high- and low-light conditions

» 2881229  
XP 4 1000/TURBO '14-18, XP 1000/TURBO '14-18, 900 XC '15-17, S 900 '15-18, 900 '15-18, 4 900 '15-18, S 1000 '16-18

## CHECK YOUR **6**

MIRRORS



## FOLDING SIDE MIRRORS TOP SELLER

- Includes left and right mirrors with mounting brackets and hardware
- Hinges feature breakaway design for tight trail conditions and easy trailering
- Mounts directly to factory roll cage at the bolt location, works with windshields and doors

» 2881198  
XP 4 1000/TURBO '14-18, XP 1000/TURBO '14-18, 900 XC '15-17, S 900 '15-18, 900 '15-18, 4 900 '15-18, S 1000 '16-18

## CONVEX REARVIEW MIRROR TOP SELLER

- Installs easily: mount bolts into your choice of pre-designated mounting locations on vehicle frame
- Convex design provides broad, expanded view of what's behind or alongside the vehicle

» 2881540  
XP 4 1000/TURBO '14-18, XP 1000/TURBO '14-18, 900 XC '15-17, S 900 '15-18, 900 '15-18, 570 S '17, 570 '12-18, 4 900 '15-18, S 1000 '16-18



SCRATCH-RESISTANT  
GLASS MIRROR LENS

## REARVIEW MIRROR TOP SELLER

- Works with all roofs, soft tops and windshields

» 2877945  
XP 4 1000/TURBO '14-18, XP 1000/TURBO '14-18, 900 XC '15-17, S 900 '15-18, 900 '15-18, 570 S '17, 570 '12-18, 4 900 '15-18, S 1000 '16-18



CONVEX DESIGN DELIVERS  
WIDE REAR VIEW

## WIDE-ANGLE REARVIEW MIRROR

- Stamped steel frame and backing plate with large 6.4 cm x 36 cm convex mirror
- Up to 10 degrees of adjustability to adjust to rider height or view preference
- Easy over-structure installation with stamped steel mounts

» 2881199  
XP 4 1000/TURBO '14-18, XP 1000/TURBO '14-18, 900 XC '15-17, S 900 '15-18, 900 '15-18, 570 S '17, 570 '12-18, 4 900 '15-18, S 1000 '16-18



QUICK GLANCE, WIDE-ANGLE  
VIEWING FOR MAXIMUM VISIBILITY



# WINDSHIELDS

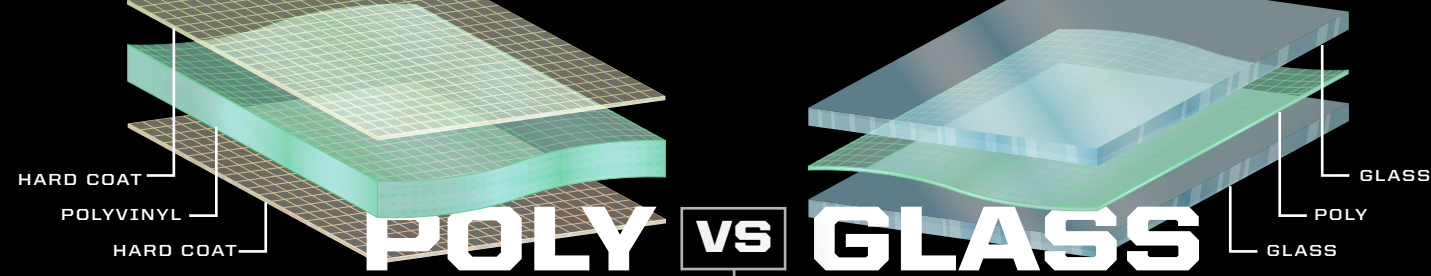

Lightweight and flexible material is **IMPACT-RESISTANT**, providing long-term value and protection. Guarantees a **TIGHT SEAL** to keep out rain and dust. **HARD COAT** provides **30x** more scratch resistance than regular poly.

Superior **OPTICAL CLARITY** for a clear view. Laminated safety glass **PROTECTS FROM SCRATCHES** and provides automotive-level visibility.

## HARD COAT POLY



### FLIP-DOWN WINDSHIELD - HARD COAT POLY

- Versatile, adjustable windshield lets you choose full protection or open-air running
- Easy to install and made of tough polycarbonate with scratch-resistant hard coat
- Two-position design can be adjusted quickly without the use of tools

» 2881616  
XP 4 1000/TURBO '14-18, XP 1000/TURBO '14-18, 900 XC '15-17, S 900 '15-18, 900 '15-18, 4 900 '15-18, S 1000 '16-18

### LOCK & RIDE VENTED WINDSHIELD - HARD COAT POLY **NEW**

- Impact-resistant polycarbonate windshield provides great visibility and protection from the elements
- Full windshield reduces driver fatigue and eye strain so you can ride longer and feel better when the ride is done
- New vents allow for temperature regulation
- Installs and removes in just minutes with new Lock & Ride® clamps

» 2883111  
XP 4 1000/TURBO '14-18, XP 1000/TURBO '14-18, 900 XC '15-17, S 900 '15-18, 900 '15-18, 4 900 '15-18, S 1000 '16-18

### LOCK & RIDE FULL WINDSHIELD - HARD COAT POLY **NEW** **TOP SELLER**

- Durable, optical-grade polycarbonate for maximum impact resistance
- Fully seals to cab frame and hood for optimized protection
- No frame for maximum visibility
- Installs and removes in just minutes with new Lock & Ride® clamps
- Integrates with all cab components

» 2883110  
XP 4 1000/TURBO '14-18, XP 1000/TURBO '14-18, 900 XC '15-17, S 900 '15-18, 900 '15-18, 4 900 '15-18, S 1000 '16-18

## GLASS



### LOCK & RIDE HALF WINDSHIELD - HARD COAT POLY **NEW** **TOP SELLER**

- Provides protection and delivers optimum airflow into the cab
- Lock & Ride® installs quickly and easily without tools
- Strong, durable, impact-resistant polycarbonate
- Fully-sealed lower section of windshield to hood

» 2883109  
XP 4 1000/TURBO '14-18, XP 1000/TURBO '14-18, 900 XC '15-17, S 900 '15-18, 900 '15-18, 4 900 '15-18, S 1000 '16-18

### VENTED WINDSHIELD - GLASS **NEW**

- 7.6 cm vent opens and closes with onehanded operation—provides immediate vent-out and increased cabin airflow
- Low profile steel frame minimizes obstruction to provide driver with maximum field of view
- Windshield is gasket-sealed to the frame to provide a leak- and whistle-free ride experience

» 2883112  
XP 4 1000/TURBO '14-18, XP 1000/TURBO '14-18, 900 XC '15-17, S 900 '15-18, 900 '15-18, 4 900 '15-18, S 1000 '16-18

### GLASS WINDSHIELD **TOP SELLER**

- Installs in minutes and integrates into a designated mounting position
- Windshield surface seals directly to the visor with no additional framework needed
- Laminated safety glass for excellent scratch resistance
- Increased visibility with a reduction of framework

» 2879447  
XP 4 1000/TURBO '14-18, XP 1000/TURBO '14-18, 900 XC '15-17, S 900 '15-18, 900 '15-18, 4 900 '15-18, S 1000 '16-18

### WINDSHIELD WIPER KIT

» 2879526  
XP 4 1000 '14-18, XP '14-18, S 1000 '16-18, ALL 900 '15-18

**NEW**

## LOCK & RIDE

Polaris® windshields feature Lock & Ride® technology, thanks to the **NEW** Lock & Ride® Cage Clamp. This innovative clamp allows for easy installation and easy removal of Polaris® poly windshields, eliminating fear of cracked trim when tightening.



## REAR PANELS

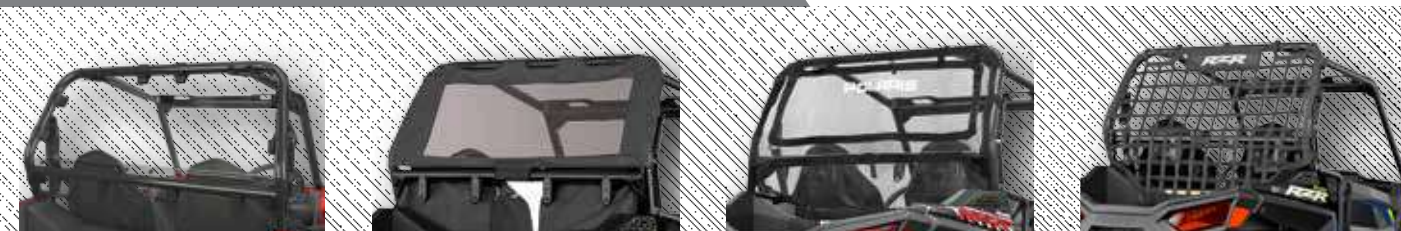

### LOCK & RIDE **TOP SELLER** REAR PANEL - POLY

» 2881613  
900 XC '15-17, S 900 '15-18, 900 '15-18, 4 900 '15-18, S 1000 '16-18

» 2881614  
XP 4 1000/TURBO '14-18, XP 1000/TURBO '14-18

» 2878752  
ALL 800 '14 MODELS

### REAR PANEL - CANVAS

• 23 oz. polyester canvas is mold-resistant for long-term performance and UV-stable to resist fading

» 2880608  
900 XC '15-17, S 900 '15-18, 900 '15-18, 4 900 '15-18, S 1000 '16-18

### REAR PANEL - MESH

» 2880409  
900 XC '15-17, S 900 '15-18, 900 '15-18, 4 900 '15-18, S 1000 '16-18

» 2879507  
XP 4 1000/TURBO '14-18, XP 1000/TURBO '14-18

### REAR RACE NET

» 2880408  
900 XC '15-17, S 900 '15-18, 900 '15-18, 4 900 '15-18, S 1000 '16-18

» 2879936  
XP 4 1000/TURBO '14-18, XP 1000/TURBO '14-18



# TAKE IT ALL STORE IT ALL

LOCK & RIDE

## COOLER BOX

- Strong one-piece rotomolded construction for extreme durability
- Lid locks securely in place with rubber latches to protect cargo. Heavy-duty hinges and a weatherproof seal block moisture and dust
- Extra thick walls with pressure-injected insulation for maximum ice retention
- Chest can keep food and beverages cool for 48 hours or longer, depending on conditions
- Cargo box is UV-resistant so it won't fade in the sun
- Lock & Ride™: Installs quickly and easily
- Integrated grab handles make easy to carry to and from your RZR™

- » 45 L  
2881555  
XP 4 1000/  
TURBO '14-18
- » 48 L  
2881556  
S 1000 '16-18,  
ALL 900 '15-18



### BED D-RINGS

- » 2877460  
XP 4 1000/TURBO '14-18, XP 1000/TURBO '14-18, 900 XC '15-17, S 900 '15-18, 900 '15-18, 570 '15-17, 570 '12-18, 4 900 '15-18, S 1000 '16-18



### D-RINGS

- » 2881544

### PLUNGER

- » 2876420

LOCK & RIDE

## CARGO BOX

TOP SELLER

- Integrated rear cargo box touting 65 liters of storage
- Secure latching lid with taut rubber strap tie-downs
- Lightweight design integrates seamlessly with RZR™ Rear Cargo Bed
- Includes all mounting hardware for complete installation

- » 2881193

XP 4 1000/TURBO '14-18, XP 1000/TURBO '14-18, 900 XC '15-17, S 900 '15-18, 900 '15-18, 4 900 '15-18, S 1000 '16-18

## UNDER-HOOD STORAGE BIN

- Perfect out of the way space for a tool kit, extra belt, tow straps corner knock-outs for bungee cords (not included) secures your cargo

- » 2882080

XP 4 1000 '14-18, XP 1000 '14-18, 900 XC '15-17, S 900 '15-18, 900 '15-18, 4 900 '15-18, S 1000 '16-18



### OVERHEAD BAG

- » 2879516  
XP 4 1000/TURBO '14-18, XP 1000/TURBO '14-18, 900 XC '15-17, S 900 '15-18, 900 '15-18, 4 900 '15-18, S 1000 '16-18



### UPPER DOOR STORAGE BAG

- » 2880612  
XP 4 1000/TURBO '14-18, XP 1000/TURBO '14-18, 900 XC '15-17, S 900 '15-18, 4 900 '15-18, S 1000 '16-18



### LOWER DOOR STORAGE BAG

- » 60" • 2880613  
XP 4 1000/TURBO '14-18, XP 1000/TURBO '14-18, 900 XC '15-17, S 900 '15-18, 4 900 '15-18, S 1000 '16-18. Requires lower door 2879509.
- » 50" • 2880616  
900 '15-18. Requires lower door 2880207.



28 LITER

57 LITER

99 LITER



## POLARIS NORTHSTAR® COOLERS

Polaris Northstar® coolers can survive just about anything—from extreme heat to a full-on bear attack. Ice will stay cold for hours on end, and anything inside will stay locked up tight.



ComfortCarry Handles



TravelLock System



EasyOut Drain System



NoSlip Rubber Feet



PolarWall Insulation



IceLock Seal

19 LITER

99 L **NEW**

- » GRAPHITE • 2883426
- » DESERT • 2883392

57 L

- » **NEW** GRAPHITE • 2883425
- » DESERT • 2881259

28 L

- » **NEW** GRAPHITE • 2883424
- » DESERT • 2881315

20 QT. (19 L) SOFTSIDE **NEW**

- » GRAPHITE • 2883390

TUMBLERS **NEW** **NOT SHOWN**

- » 887 ML • 2883394
- » 592 ML • 2883393

## POLARIS NORTHSTAR® COOLER ACCESSORIES



### WIRE BASKET

- » 56.8 L **SHOWN** • 2882185

- » 28.4 L • 2882438



### SEAT CUSHION

- » 2882179 **SHOWN** • 56.8 L
- » 2882507 • 28.4 L



### TIE-DOWN STRAPS

- » RED • 2859047-01
- » BLACK • 2859047-02



### COOLER WHEELS

- » 2882180 • 56.8 L



### BOTTLE OPENER

- » 2882183

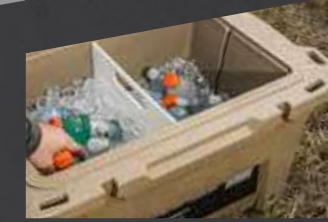

### DIVIDERS/ CUTTING BOARDS

- » 56.8 L **SHOWN** • 2882184

INCLUDES TWO

- » 28.4 L • 2882186

INCLUDES ONE



2 WAYS TO PARTITION

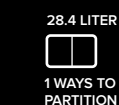

1 WAYS TO PARTITION

\*YETI is a registered trademark of YETI COOLERS, LLC



**HD** HEAVY DUTY SERIES

**4500 LB. (2041 KG) WINCH**



FAIRLEAD

**POLARIS® PRO HD 4500 LB (2041 KG) WINCH**

TOP SELLER

- 1 year warranty
- Auto-Stop technology stops winch at end of pull to prevent over-lifting
- Corded remote control
- 15 m of 6 mm premium, high-strength synthetic rope

» 2881672

ALL XP 1000 '14-18, ALL TURBO EPS '16-18, 1000 S EPS '16-18, ALL 900 '15-18

VISIT [POLARIS.COM/HARNESSES\\_GUIDE](http://POLARIS.COM/HARNESSES_GUIDE) FOR REQUIRED WIRING KITS.

**AUTO-STOP TECHNOLOGY**

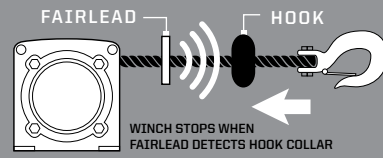

**HD** HEAVY DUTY SERIES

**3500 LB. (1588 KG) WINCH**

15 M OF .56 CM HIGH-STRENGTH STEEL CABLE

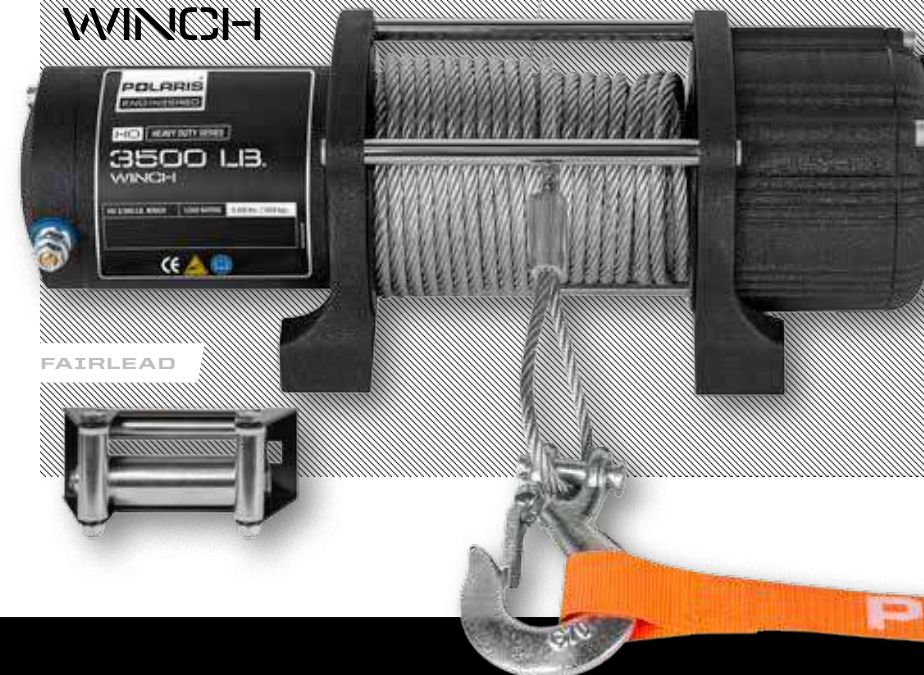

FAIRLEAD

**POLARIS® HD 3500 LB (1588 KG) WINCH**

TOP SELLER

- 1 year warranty
- Integrated design with quick-connect power—installs in minutes
- Fully sealed motor, contactor, and drivetrain
- 15 M of high-strength steel cable

» 2881671

ALL XP 1000 '14-18, ALL TURBO EPS '16-18, 1000 S EPS '16-18, ALL 900 '15-18

VISIT [POLARIS.COM/HARNESSES\\_GUIDE](http://POLARIS.COM/HARNESSES_GUIDE) FOR REQUIRED WIRING KITS.

DURABLE, CORROSION-RESISTANT FINISH

**WINCH ACCESSORIES**

**SOFT STEEL WINCH CABLE**

» 2878890  
1588 KG WINCH



**POLARIS® WIRELESS WINCH REMOTE**

» 2879316  
ALL WINCHES



**UPGRADE YOUR HD WINCH TO A PRO WINCH WITH THESE ACCESSORIES**

**POLARIS® PRO HD WINCH UPGRADE KIT**

» 2879149



**SYNTHETIC WINCH ROPE**

» 2041 KG • 2879187

» 1588 KG • 2878888  
USE WITH POLARIS® PRO HD WINCH UPGRADE KIT



**GLACIER® HD PLOW SYSTEM**



**CREATE YOUR GLACIER PRO PLOW SYSTEM**

To complete your Polaris® plow system, you will need four components: a mount, a push frame, a lift method and a blade.

**STEP 1: ADD A MOUNT**  
GLACIER PRO MOUNT

» 2880262  
900 XC '15-17, S 900 '15-18, 900 '15-18, 4 900 '15-18, S 1000 '16-18

**STEP 2: SELECT PUSH FRAME**  
GLACIER PRO PLOW FRAME

» 2880260

**GLACIER PRO PLOW EXTENSION**

» 2880267  
REQUIRED TO USE GLACIER PRO PLOW SYSTEM WITH TRACKS

**STEP 3: SELECT A LIFT METHOD**  
POLARIS® PRO HD 4500 LB. (2041 KG) WINCH

» 2881672  
ALL XP 1000 '14-18, ALL TURBO EPS '16-18, 1000 S EPS '16-18, ALL 900 '15-18

**POLARIS® HD 3500 LB. (1588 KG) WINCH**

» 2881671  
ALL XP 1000 '14-18, ALL TURBO EPS '16-18, 1000 S EPS '16-18, ALL 900 '15-18

**STEP 4: SELECT A BLADE**  
GLACIER PRO PLOW 168 CM STEEL BLADE

» 2880268

**GLACIER PRO PLOW 168 CM POLY BLADE**

» 2880269

**PLOW ACCESSORIES**

**PLOW BLADE SNOW DEFLECTOR**

» 2879866 • 168 CM

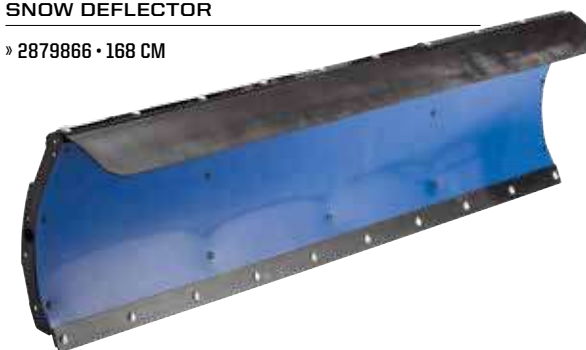

**STANDARD WEAR BAR**

» 2879867 • 168 CM

**HD WEAR BAR**

» 2879868 • 168 CM



- Dual bogie wheels manage weight properly and deliver a great ride and outstanding traction in snow
- Enhance traction, flotation and mobility in snow

**NON EPS MODEL**

» 2880757  
XP 900 MY13-14, CREW 900 MY14-16, NON EPS: 20 FRONT 18 REAR  
500 lbs maximum cargo load with tracks installed

» MOUNTS • 2880648  
900 '15-18'

**EPS MODEL**

» 2880758  
XP 900 MY13-14, CREW 900 MY14-16, EPS: 18 FRONT 18 REAR  
500 lbs maximum cargo load with tracks installed  
For use on models that come with factory-installed eps  
Works with glacier pro only

» MOUNTS • 2880649  
900 XC '15-17, S 900 '15-18, 4 900 '15-18, S 1000 '16-18



## CLICK-6 HARNESSSES

- Racing-quality premium construction for the greatest security and protection
- Six straps hold a driver securely in place in all riding conditions
- One-click, quick-release buckle releases straps, allows easy egress

### » DRIVER SIDE • 2882244

XP 1000/TURBO '14-18, 900 XC '15-17, S 900 '15-18, 900 '15-18, S 1000 '16-18

### » PASSENGER SIDE • 2882245

XP 1000/TURBO '14-18, 900 XC '15-17, S 900 '15-18, 900 '15-18, S 1000 '16-18



## RZR SUBZERO 4

### » 2882281

XP 1000/TURBO '14-18, 900 XC '15-17, S 900 '15-18, 900 '15-18, S 1000 '16-18

### » 2882282

XP 1000/TURBO '14-18, 900 XC '15-17, S 900 '15-18, 900 '15-18, S 1000 '16-18



## SEAT ADJUSTER KIT

### » 2877390

XP 4 1000/TURBO '14, 900 '14, 570 S '17, 570 '12-18



## SEAT SLIDER

### » 2879460

XP 4 1000/TURBO '14-18, XP 1000/TURBO '14-18, 900 XC '15-17, S 900 '15-18, 900 '15-18, 4 900 '15-18, S 1000 '16-18

## EPS KIT

### » 2879522



## TURBO HOOD

### » 2881467

ALL 900 '15-16



## LIMITED TIME OFFER

### RZR® NEON SIGN

### » 2882478



## RZR® WHIP FLAG

### » 2881468

XP 4 1000/TURBO '14-18, XP 1000/TURBO '14-18, 900 XC '15-17, S 900 '15-18, 900 '15-18, 570 S '17, 570 '12-18, 4 900 '15-18, S 1000 '16-18

## LOCK & RIDE FLAG MOUNT

### » 2877502

XP 4 1000/TURBO '14-18, XP 1000/TURBO '14-18, 900 XC '15-17, S 900 '15-18, 900 '15-18, 570 S '17, 570 '12-18, 4 900 '15-18, S 1000 '16-18



## HORN KIT

### » 2880416

XP 4 1000/TURBO '14-18, XP 1000/TURBO '14-18, 900 XC '15-17, S 900 '15-18, 900 '15-18, 4 900 '15-18, S 1000 '16-18

### » 2877788

XP 4 1000/TURBO '14, 900 '14, 570 S '17, 570 '12-18



## ALL WEATHER FLOOR MATS

### » FRONT 2880414

XP 4 1000/TURBO '14-18, XP 1000/TURBO '14-18, 900 XC '15-17, S 900 '15-18, 900 '15-18, S 1000 '16-18

### » FRONT & BACK 2880415

XP 4 1000/TURBO '14-18, 4 900 '15-18

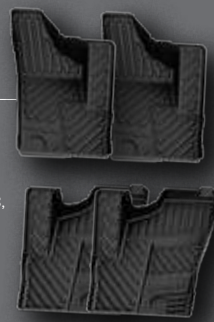

## OFF-ROAD JACK KIT

### » 2881201

XP 4 1000/TURBO '14-18, XP 1000/TURBO '14-18, 900 XC '15-17, S 900 '15-18, 900 '15-18, 570 S '17, 570 '12-18, 4 900 '15-18, S 1000 '16-18



## RIDE & REPAIR ESSENTIALS KIT

### » 2881207

XP 4 1000/TURBO '14-18, XP 1000/TURBO '14-18, 900 XC '15-17, S 900 '15-18, 900 '15-18, 570 S '17, 570 '12-18, 4 900 '15-18, S 1000 '16-18



# 570

## LOCK & RIDE SPORT ROOF

### » BLACK • 2878748

900 '14, 570 S '17, 570 '12-18

## HALF WINDSHIELD

### » 2879493

900 '14, 570 S '17, 570 '12-18

## LOCK & RIDE

## POLY WINDSHIELD

### » 2879492\*

900 '14, 570 S '17, 570 '12-18

## FRONT DELUXE BRUSHGUARD

### » 2878284

XP 4 1000/TURBO '14, 900 '14, 570 S '17, 570 '12-18

## POLARIS HD 3500 LB WINCH

### » 2879334



## REAR DELUXE BRUSHGUARD

### » 2878697

570 S '17, 570 '12-18

# 170

## HALF WINDSHIELD

- Provides protection from rain, debris and branches
- Installs easily and securely

- Retains open-air riding environment
- Adds sporty style

### » 2877684

170 '09-18



## FRONT BRUSHGUARD

- Strong, tough, and protective
- Styling and finish complement vehicle's look

- Protects front end of vehicle from impact
- Easy bolt-on installation

### » 2877813

170 '09-18



## SOFT TOP

- Adds sporty styling and offers protection
- Provides shade for riders

- Protects against rain, overhead branches, etc.
- Easy installation

### » 2877685

170 '09-18







## SPECIFIC NEEDS, SPECIFIC OILS

Polaris® invests millions in engine development, and part of that investment is making sure its lubricants—critical to engine performance—are the right formula for your specific engine. The amount of testing data and engineering resources used in developing Polaris® lubricants would overwhelm an aftermarket company. Therefore, the aftermarket must spec an oil to an industry-wide standard that must account for a variety of operating parameters.

PS-4 is designed specifically for Polaris® 4-cycle engines and has high film strength and wear protection under extreme loads and temperatures. Exclusive anti-wear additives protect engine parts with extra rust and corrosion protection.

### PS-4 FULL-SYNTHETIC OIL

- PS-4 is optimal for ambient operating temperatures of -40° C to 38° C
- » 1 L • 2876244
- » 3.8 L • 2876245
- » 61 L • 2876247
- » 208 L • 2876246
- » 1249 L • 2878814

### PS-4 OIL CHANGE KIT

- Contains the correct amount of oil for your vehicle and correct oil filter
- » 2202166  
SINGLE 570, TWIN 600, TWIN 700, TWIN 800
- » 2879323  
RANGER/RZR 900/1000
- » 2880913  
POLARIS ACE/ETX 325
- » 2877473  
330-500, SPORTSMAN 550/850/1000

### ORV MAINTENANCE KIT

- Includes: 1.4 L AGL, 1 L Angle Drive Fluid, .5 L Demand Drive Fluid, 89 ml tube of All-Season Grease
- » 2880425

### PS-4 EXTREME-DUTY FULL-SYNTHETIC OIL

- PS-4 Extreme Duty is optimal for ambient operating temperatures of -18° C to 53° C
- » 1 L • 2878920
- » 3.8 L • 2878919
- » 61 L • 2879003
- » 208 L • 2879002
- » 1249 L • 2879001

### PS-4 EXTREME-DUTY OIL CHANGE KIT

- Contains the correct amount of oil for your vehicle and correct oil filter
- » 2879004  
SINGLE 570, TWIN 600, TWIN 700, TWIN 800
- » 2878924  
330-500, SPORTSMAN 550/850/1000
- » 2879324  
RANGER/RZR 900/1000
- » 2881697  
RZR TURBO

## POLARIS® PS-4 VS THE COMPETITION

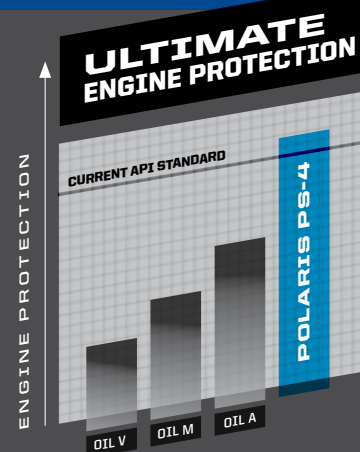

Polaris® PS-4 oils exceed the latest industry protection standard as set by the API, while the competition uses standards from years ago. Our proprietary additives clean and protect critical engine parts under high operating temperatures.

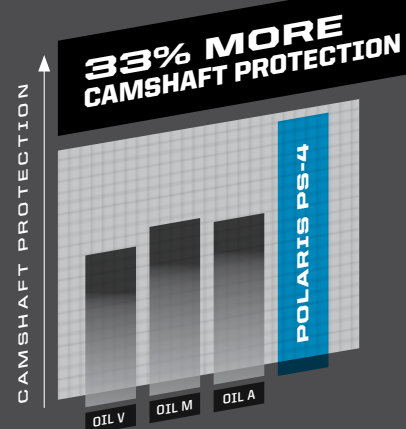

When tested against competitive oils, camshaft bearing races and lobes exhibit less wear when protected by Polaris® PS-4 oil.

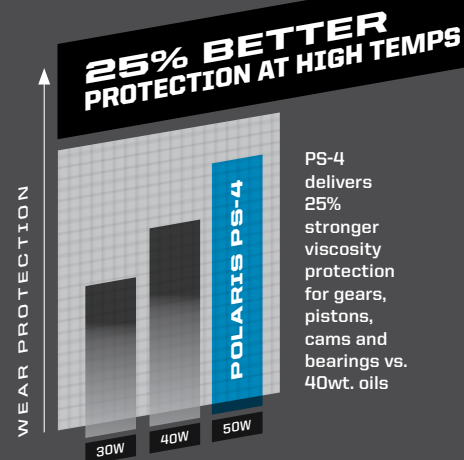

PS-4 delivers 25% stronger viscosity protection for gears, pistons, cams and bearings vs. 40wt. oils

**WHY VISCOSITY MATTERS:** Polaris® engines are designed to operate using oils rated at a specific viscosity. Viscosity is the measure of an oil's resistance to flow and shear and a way to gauge an oil's "film strength", which is a critical component in preserving engine life when an oil is subject to high heat or heavy loads.

## ENGINEERED TO MAXIMIZE THE LIFE OF YOUR RIDE

All Polaris® fluids—from anti-freeze to brake fluid—are developed for your vehicle. Trust the only fluids perfectly engineered for your needs.

### AGL

A proprietary blend of additives designed to optimize Polaris® ORV transmission life. Extreme pressure additives protect gears, drive chain, and bearings from scoring and wear. Unlike typical gear case oils, AGL's unique viscosity range allows instant flow and film protection in extreme cold or high heat environments

- » 1 L • 2878068
- » 3.8 L • 2878069
- » 9.5 L • 2878070
- » 208 L • 2879594

Proper lubricant application and timing will ensure optimal vehicle performance. Please refer to your owner's manual for lubricant change interval schedules.



### DOT 4 BRAKE FLUID

Polaris® DOT 4 Brake Fluid is a high-quality brake fluid designed for use in Polaris® hydraulic brakes. Superior high-temp characteristics plus anti-corrosive additives extend the life of brake system components and provide consistent, positive braking

» 355 ML • 2872189

### ANTI-FREEZE

Polaris® Extended Life Coolant contains organic acid technologies to prevent corrosion on metal components, eliminate scaling, and maximize cooling system performance

- » 1 L • 2880514
- » 3.8 L • 2880513
- » 208 L • 2880512

### DEMAND DRIVE FLUID

Engineered specifically for Polaris® ORV front drive systems. Provides positive 4WD engagement in extreme cold or high heat conditions. Unique friction additives protect internal components under heavy loads and promote positive engagement

- » 1 L • 2877922
- » 9.5 L • 2877923

### U-JOINT GREASE

Polaris® U-Joint Grease is a heavy-duty lubricant formulated with molybdenum disulfide to accept the high shock applications of Polaris® ATV shaft drive universal joints

- » 88.7 ML • 2871515
- » 414 ML • 2871551

## LUBE ACCESSORIES



### GREASE GUN KIT

- » 2871312  
FITS 2871322 ALL-SEASON AND 2871322 U-JOINT 89 ML

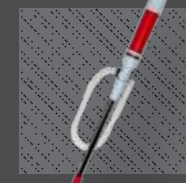

### 2D BATTERY-OPERATED SIPHON PUMP

- Liquid transfer pumps 5.7 L/min suctioning power.
- Use with gas, water, oil, and other non-corrosive liquids
- » 2830513



### FLEX SPOUT

- Convenient easy pour flex spout fits all Polaris® quart, gallon, and 9.5 Liter bottles
- » 2871285

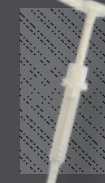

### PUMP

- » 2870465  
ATTACHES TO 3.8 LITER OR 9.5 LITER BOTTLE FOR EASY, NO-DRIP DISPENSING



### PREMIUM GAS SHOCK OIL

- » 1 L • 2870995
- » 9.5 L • 2872279  
FOX® REBUILDABLE SHOCKS



### 10WT GAS SHOCK OIL

- » 1 L • 2874124  
WALKER EVANS® REBUILDABLE SHOCKS



### ANGLE DRIVE FLUID

- » 1 L • 2876160
- » 9.5 L • 2872276  
SPORTSMAN, RANGER, RZR ANGLE DRIVE GEAR CASE SYSTEMS



### CHAIN LUBRICANT

- » 473 ML AEROSOL 2872348



### ALL-SEASON GREASE TUBE

- » 89 ML 2871322
- » 414 ML 2871423



### CARBON CLEAN

- Polaris® Carbon Clean prevents ethanol corrosion, stabilizes fuel, and cleans fuel injectors, piston ring lands, intake systems and combustion chambers. Helps maintain peak HP and improves fuel economy

- » 355 ML • 2881413



### ADVANCED FUEL TREATMENT

- Advanced Fuel Treatment prevents ethanol corrosion and stabilizes fuel for up to 2 years. Dual-antioxidant formula protects against gum and varnish for easy starting

- » 355 ML • 2881416
- » 9.5 L • 2881417



### SCENTED ADVANCED FUEL TREATMENT

- 29.5 ml pouch treats 18.9 Liters of fuel
- Scented formulas provide pleasant fragrance through the exhaust system
- Alcohol free: safe for all powerports applications

- » MINT • 2881418
- » STRAWBERRY • 2881419
- » UNSCENTED • 2881420
- » 25 - 29.5 ML POUCHES OF EACH FORMULA • 2881421



# FOR THE LIFE OF YOUR RIDE

## THE KEY TO KEEPING YOUR POLARIS® OFF-ROAD VEHICLE PERFORMING

as well as the day you brought it home is proper maintenance. Items like belts, filters and batteries represent only a few of these critical items engineered specifically by Polaris®.

CHECK OUT OUR [PARTS FINDER ON POLARIS.COM](https://www.polaris.com) FOR EASY PARTS LOOK-UP, PARTS IDENTIFICATION, VIEWS OF ASSEMBLIES AND MORE!

## POLARIS ENGINEERED™ DRIVE BELTS

Polaris Engineered™ belts deliver unmatched performance for your off-road vehicle. Our belts are developed and tested on all our engines for all environments and conditions. This ensures it doesn't merely fit your vehicle—it outperforms your expectations.



### TESTED, PERFECTED

We test each belt on the intended vehicle – we don't try to make an existing belt "just work." The tolerances are tighter than aftermarket alternatives, meaning less heat for your engine, and you won't have to recalibrate your clutch in order to run at the engine's optimal RPM. Aftermarket belts fluctuate in and out of the optimal power band, which means more wear on your clutch and more maintenance needed to maintain power.

### OUR INVESTMENT

We average **32,186 km** of field testing and **thousands of dyno hours** on each engine to ensure the Polaris® drive belt on your machine gives you peak performance with each and every ride.

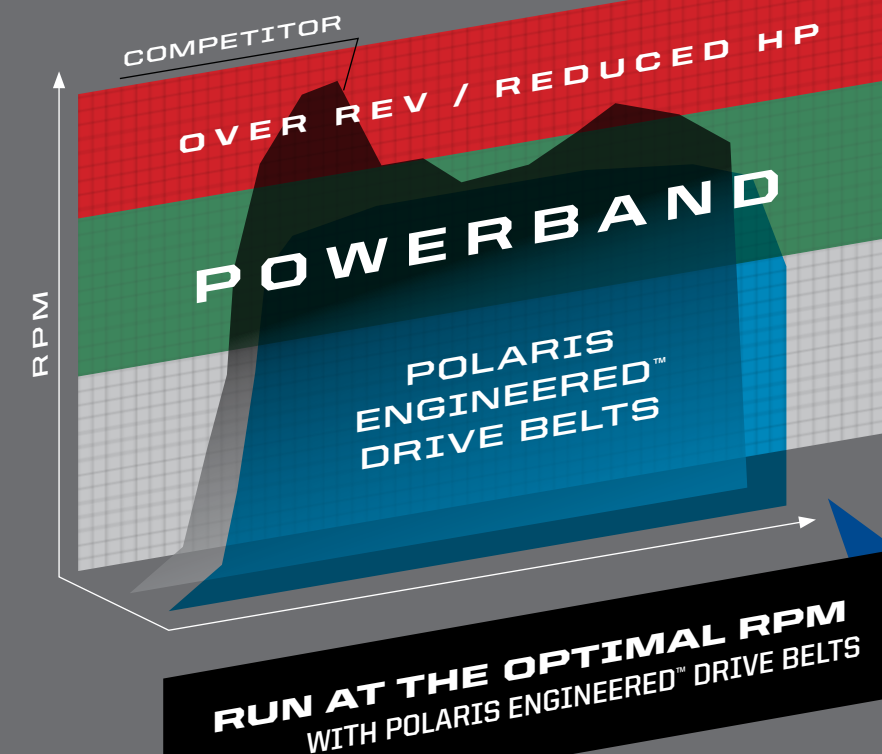

## MAINTENANCE SCHEDULE

CHECK YOUR OWNER'S MANUAL FOR ADDITIONAL RECOMMENDED SERVICE ITEMS AND VEHICLE SPECIFIC TIMING

25 HRS/805 KM	100 HRS/1610 KM	150 HRS/2414 KM	200 HRS/3219 KM	350 HRS/5633 KM	500 HRS/8047 KM
<b>BREAK-IN MAINTENANCE</b>	<b>12 MONTHS</b>	<b>18 MONTHS</b>	<b>24 MONTHS</b>	<b>30 MONTHS</b>	<b>36 MONTHS</b>
<b>ENGINE OIL:</b> CHANGE  <b>GENERAL LUBRICATION:</b> ALL FITTINGS, PIVOTS, CABLES, ETC.  <b>AIR FILTER:</b> INSPECT & CLEAN REPLACE AS NEEDED	<b>ENGINE OIL:</b> CHANGE  <b>DRIVE BELT:</b> INSPECT & ADJUST REPLACE AS NEEDED  <b>TRANSMISSION FLUID:</b> CHANGE	<b>ENGINE OIL:</b> CHANGE  <b>BATTERY:</b> TEST, CLEAN, & CHECK FLUID LEVEL REPLACE AS NEEDED  <b>DRIVE BELT:</b> INSPECT & ADJUST REPLACE AS NEEDED  <b>TIRES:</b> INSPECT CONDITION & PRESSURE	<b>ENGINE OIL:</b> CHANGE  <b>BRAKE PADS &amp; FLUID:</b> INSPECT & CLEAN REPLACE AS NEEDED  <b>SPARK PLUGS:</b> INSPECT REPLACE AS NEEDED	<b>ENGINE OIL:</b> CHANGE  <b>BATTERY:</b> TEST, CLEAN, & CHECK FLUID LEVEL REPLACE AS NEEDED  <b>DRIVE BELT:</b> INSPECT & ADJUST REPLACE AS NEEDED  <b>GENERAL LUBRICATION:</b> ALL FITTINGS, PIVOTS, CABLES, ETC.	<b>ENGINE OIL:</b> CHANGE  <b>AIR FILTER:</b> INSPECT, CLEAN REPLACE AS NEEDED  <b>COOLANT:</b> CHECK LEVEL REPLACE EVERY 2 YEARS  <b>GEARCASES:</b> CHECK OIL LEVEL



# POLARIS POWER®

**POWERFUL, PORTABLE, DURABLE.** These digital inverter generators are built to match your outdoor lifestyle, and are tested to the same rigorous standards as every Polaris® product. The 1000-watt generator is best for running a single device with low wattage requirements. The 2000-watt generator runs multiple devices with added surge protection and start-up wattage. The 3000-watt generator handles high-output needs and runs multiple devices. It also includes electric start for ease of use when needed.

## WHICH GENERATOR FITS YOUR NEEDS?

- 1 START** by adding up the running watts of everything you might power at the same time. (use the chart on below)
- 2 NEXT**, pick the device with the highest running watts, and add its starting watts to the previous total.
- 3 NOW** you have the total amount of watts you need from your generator. Select a generator with a slightly higher wattage.

	Startup Wattage	Running Wattage
140 CM LCD TV	0	150
CROCK POT	0	200
RADIO	0	50-200
LAPTOP	0	200-250
625W MICROWAVE	0	625
FRIDGE OR FREEZER	700	700
COFFEE MAKER	1300	800
SUMP PUMP: ½ HP	1300	800
BLENDER	1000	1000
ELECTRICAL GRIDDLE	0	1500
18.4 CM CIRCULAR SAW	1700	1400
AIR CONDITIONER	1500	1500



### POLARIS POWER® INVERTER GENERATORS

- » 1000 WATT • P136DGBNA
- » 2000 WATT • P136DGBNA
- » 3000 WATT • P136DGCNA



#### POLARIS POWER® CABLE KIT

- Use a parallel cable kit to easily connect two Polaris Power® generators together to increase the total power available to a load

» 3410281



#### POLARIS POWER® TIE-DOWN LEADS

- Secure your Polaris Power® Generator by inserting the Lock & Ride® Tie Down Leads into the handle and running a strap across to tie down the generator
- Secures Lock & Ride® accepting gear
- Safely provides a point for 2.5 cm wide tie down strap

» 2880959



#### POLARIS POWER® COLD WEATHER KIT

- Ensure smooth running of your Polaris® Generator in sub-zero temperatures
- Prevents ice blockage in the crankcase breather tube, which may lead to operational issues including oil leakage
- Installation required, no need to disconnect for warm weather operation
- Exclusively designed for use with Polaris® P1000i & P2000i inverter generators

» 2881433



#### POLARIS POWER® GENERATOR OIL

Corrosion inhibitors protect against rust and oxidation during long-term storage.

» 1 QUART • 2879383

#### POLARIS POWER® GENERATOR STORAGE COVERS

- Keep your generator looking like new with a strong, durable cover that is resistant to mold, mildew, tears and abrasions

» 1000 WATT COVER • 2686441

» 3000 WATT COVER • 2686443

» 2000 WATT COVER • 2686442



### POLARIS® FLEX JUMPSTARTER

12,000 mAh capacity. Two 5V/2.1A USB outputs, 200-lumen flashlight and a digital battery life monitor. Includes storage case, smart jumper cables, car charger, wall charger, and user guide. 1-year limited warranty.

» 2830495



Never let a dead vehicle battery slow you down again. The Polaris® Flex Jumpstarter is a compact solution that provides the power to get your ride started. Flex is small enough to be stored in your glovebox, and holds its charge so you can count on it when it's needed. In addition to being able to jumpstart ATVs, ORVs, snowmobiles, motorcycles, cars, & trucks, Flex can also charge any USB capable device through its dual USB outlets. Flex has the ability to jumpstart up to a 6.4L engine.

## BatteryMINDER®

Make sure your vehicle's battery is properly maintained and ready for when you need it the most with a BatteryMINDER®. A tired battery is waiting for the perfect time to ruin your day, so make sure it gets charged and cycled properly. Easily one of the most essential pieces of equipment every garage needs.



#### BATTERYMINDER® 1510 1.5-AMP

- Recovers weak batteries
- Ambient temperature sensor with wide operating range ensures the battery will never be overcharged or undercharged regardless of temperature extremes
- Extends battery life up to four times when compared to new batteries not being properly charged or maintained over their lifetime
- Automatic full-time high frequency (not high voltage) pulse type desulfation
- Reverse polarity, short circuit, and over temperature protection

» 2830404

#### BATTERYMINDER® 2012 AGM 2-AMP

- Designed for High-Performance Specialty AGM Sealed Batteries
- Guaranteed to never overcharge, regardless of how long connected
- Temperature compensation ensures proper charge in hot or cold environments
- Ambient temperature sensor with wide operating range ensures the battery will never be overcharged or undercharged regardless of temperature extremes
- Maximizes battery life and capacity, reconditions weak batteries

» 2830438

#### BATTERYMINDER® 1.5 AMP CONVERTIBLE

- BatteryMINDER® 1.5 AMP On-board or Benchtop Charger/Maintainer
- Complete with two mounting brackets for multiple vehicles/locations, fully-insulated battery clips, and ring terminal-assembly for permanent direct-to-battery attachment.
- Charges, Maintains, Recovers 12-volt batteries
- Maintains up to four batteries at a time
- Attaches to battery while in vehicle or for use on benchtop
- Guaranteed to never under- or overcharge
- Recovers and reconditions deeply discharged batteries automatically, using high-frequency pulse type desulfation circuitry
- Can extend battery life up to four times

» 2830511

#### BATTERYMINDER® EZ CONNECT

- Allows for quick and easy connecting and disconnecting of your BatteryMINDER®, includes a set of ring terminals

» 2830411

#### BATTERYMINDER® 3.65 M CABLE

- Made with heavy-duty 16 gauge black zip cord featuring automotive SAE bullet connectors

» 2830410

#### BATTERYMINDER® SPLITTER

- A simple, safe, and affordable way to connect two batteries simultaneously for easy battery maintenance, cap includes a set of ring terminals

» 2830409

#### BATTERYMINDER® RING TERMINAL

- Features 61 cm long 18-gauge wire
- Plug has standard .8 cm negative and .95 cm positive terminals
- Replaceable 15-amp in-line fuse for circuit protection
- Uses SAE quick connector and cap

» 2830437



# TOOL STORAGE SOLUTIONS

# 1

Give your tools a dedicated spot with a properly sized rolling base. Extra-deep drawers are great for storing power tools and bulky items.

## CHOOSE YOUR BASE

Raise-and-release drawer pulls keep drawers secure when moving

Drawers use roller-bearing glides

Full-width wrap-around aluminum drawer pulls



### POLARIS® 30" (76.2 CM) 5-DRAWER ROLLER CABINET

• 78 cm W x 104 cm H x 52 cm D  
» TEXTURED FINISH 2830406\*

Two extra-deep drawers allow storage of large and bulky tools



### POLARIS® 41" (104 CM) 11-DRAWER ROLLER CABINET

• 104 cm W x 105 cm H x 46 cm D  
» TEXTURED FINISH 2830408\*  
» HIGH-GLOSS FINISH 2830451\*



### POLARIS® 72" (183 CM) 19-DRAWER ROLLER CABINET

• 183 cm W x 120 cm H x 64 cm D  
» HIGH-GLOSS FINISH 2830492\*

Three extra-long drawers provide storage for tools of all shapes and sizes

# 2

Polaris® offers two types of tops: Portable and permanent.

## CHOOSE YOUR TOP



### POLARIS® 30" (76.2 CM) PORTABLE WORKSTATION

• 78 cm W x 52 cm H x 44.5 cm D  
» TEXTURED FINISH 2830405  
\* TOOLS NOT INCLUDED



### POLARIS® 41" (104 CM) PORTABLE WORKSTATION

• 104 cm W x 55 cm H x 45 cm D  
» TEXTURED FINISH 2830407  
\* TOOLS NOT INCLUDED



### POLARIS® 41" (104 CM) STANDARD TOP CHEST

• 103 cm W x 52 cm H x 50 cm D  
» HIGH-GLOSS FINISH 2830450\*



### POLARIS® 72" (183 CM) STAINLESS STEEL TOP

• 183 cm W x 2.5 cm H x 64 cm D  
» 2830496

\* Tools not included

## DON'T FORGET THE FINISHING TOUCHES

# 3

Complete the organizing with a strategically placed caddy.

## UPGRADE



### POLARIS POWER® TOOL CADDY

• Hangs from fence rail of roller tool cabinets  
» SILVER • 2830430  
\* Tools not included



### POLARIS® HAND TOOL CADDY

» SILVER • 2830431  
\* Tools not included



### POLARIS® BADGES

» RANGER® • 2830413  
» RZR® NOT SHOWN 2830412

## FINISH YOUR GARAGE



### POLARIS® MAGNETIC PARTS TRAY

» SILVER • 2830432

### POLARIS® 33" (84 CM) TELESCOPIC MAGNET

» BLACK • 2830435



### POLARIS® 12" (30.5 CM) HI-TORQUE RATCHETING DRIVER

» BLACK / BLUE • 2830434

### POLARIS® LED POCKET FLASHLIGHT

» BLACK • 2830436



### POLARIS® HEAVY-DUTY SCRUBBER WIPES

» 90 COUNT 2830441



### POLARIS® SHOP TOWELS

» 200 COUNT SHOP TOWEL ROLL WITH DISPENSER SHOWN 2830402  
» 200 COUNT REFILL 2830403  
» 64 COUNT SHOP TOWEL REFILL • 2830440

## NEW



## ROLL IT WHERE YOU NEED IT

Inspired by the carts that top racing teams use, this cart offers the best in storage and portability. Whether in the shop or out in the field, your tools go where you need them the most.

### TOOL CART

- Rolling design allows for maximum portability
  - Multiple-depth drawers securely hold hand tools, power tools and more
  - Large tires for performance in all types of terrain
  - Take your tools where you need them easily and securely
- » 79 CM WIDE X 49 CM DEEP X 100.3 CM HIGH 2830512



# ELEVATE YOUR WORK



## POLARIS® VEHICLE LIFT

- Get fast, easy access to the underside of your vehicle
- Manual and pneumatic operation available

» 547 KG  
2830424

- Raises vehicle up to 81 cm to make repairs & maintenance faster and easier
- Dual-locking safety latch for added safety

» 143 KG  
2830425

## POLARIS® VEHICLE LIFT ATTACHMENTS

- » RZR®/RANGER® 2830428
- » ATV/POLARIS ACE® 2830427
- » SNOWMOBILE 2830426



## POLARIS® X3 CREEPER

- Three positions: flat, 45-degree angle or seated work stool
- Helps you perform any repair with ease
- Stay dry and warm away from cold, wet cement floors
- Easily stores away when not in use

» BLACK • 2830429

## PREMIUM TIRE SEALANT

- Instantly seals and repairs rim, bead leaks, and punctures up to .62 cm on standard tires, and 1.91 cm on heavy ply tires
- Helps maintain air pressure for the life of the tire
- Helps seal the tire bead against the wheel
- 100% water soluble for easy cleanup.
- Will not rust, corrode, or pit wheels
- Creates permanent repair
- Remains fluid and effective in temperatures down to -43° C
- Easily installed through existing tire valve stem with valve core removed

» 946 ML • 2830484  
» 3.8 LITERS • 2830485  
» 18.9 LITERS • 2830486

» 18.9 LITER PUMP • 2830487  
» 208 LITER • 2830489  
» 1041 LITER • 2830488



## HOW IT WORKS

Tire sealant remains liquified inside your tire until a leak develops in the tire or wheel.

Once a leak occurs, the tire sealant rushes out of the tire and quickly creates a permanent solid plug.

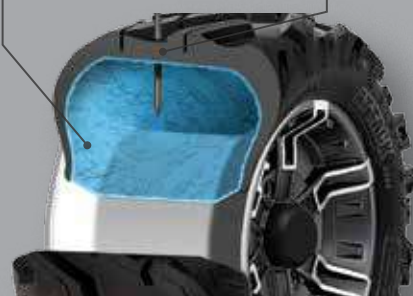

The sealant plug maintains the pressure of the tire so you can continue your ride.

# KEEP IT CLEAN

## PRE-TREAT

### MUD SHIELD® PRE-TREATMENT

- Inhibits the adhesion of dirt, mud, and snow, making cleaning your vehicle faster and easier.
- » 473 ML AEROSOL

### NEVER RUST SPRAY®

- Synthetic formula highly resistant to water protects against rust and corrosion while lubricating metal surfaces.
- » 473 ML AEROSOL

## CLEAN

### XP WASH®

- Foaming, highly-concentrated wash easily removes the most stubborn and intense dirt build-up.
- » 946 ML

### XP SPRAY WASH®

- Effortless biodegradable, high-performance wash ideal for removing dirt, oils and carbon—simply spray on, spray off and go.
- » 946 ML

### ALL-PURPOSE CLEANER

- Professional grade, non-streak, foam formula cuts through grease dirt and film leaving an invisible, dirt-resistant barrier for long-lasting results.
- » 473 ML

### GLASS CLEANER

- Heavy-duty foam non-streak formula cuts through grease, dirt, dried bugs and film leaving a crystal-clear dirt-resistant barrier for long-lasting results.
- » 473 ML

## SHINE

### POLARIS® POLISH

- Easy protection and shine—spray on, wipe off, and go. For ideal use on painted and plastic surfaces. Contains carnauba wax.
- » 473 ML

### INSTANT SHINE & DETAILER

- Spray and wipe formula—cleans, polishes, and protects plastic and painted surfaces.
- » 473 ML

## TRAILERING



### RampPro BY CALIBER®

- Designed for ATVs and UTVs up to 127 cm wide
- Integrated grip glides for ultimate traction
- Sides fold for compact transportation
- » 132 CM × 229 CM • 2883005

### ALUMINUM ARCHED LOADING RAMPS

- » 907 KG CAPACITY • 193 CM × 30 CM 2875384
- » 1,361 KG CAPACITY • 224 CM × 30 CM 2875386

### LIGHTWEIGHT TRI-FOLD RAMPS

- Ramp folds up for transport
- Capacity for up to 1,500 lbs (680.7 kg)
- Safety straps included
- » 183 CM × 130 CM • 2875385
- » 208 CM × 130 CM • 2875860

### FOLDING ALUMINUM ARCHED RAMPS

- Ramp folds up for transport
- Capacity up to 1,500 lbs (680.7 kg)
- Safety straps included
- » 224 CM × 30 CM • 2875387

### RECEIVER HITCH

- » 5 CM RECEIVER • 2875320
- » FRONT HITCH RECEIVER • 2878846



### TRAILER BALL 1.9 CM SHANK

- » 5.4 CM • 2877602
- » 5 CM • 2877603



### TIE-DOWN RATCHET STRAPS

- 3.8 cm shock-strap ratchet with safety strap
- » 2859047-01 • RED
- » 2859047-02 • BLACK



### RZR® COVERS

- » 2880327 •
- » 2880325 •
- » 2879373 • XP 1000
- » 2879407-067 •



## SHOP CLEANERS

### ALL-PURPOSE CLEANER PLUS

- Professional-grade formula removes built-up stains from shop floors, work benches, and other hard surfaces. VOC-free, environmentally-friendly, and biodegradable.
- » 3.8 L • 2830414
- » 19 L • 2830416

### VEHICLE & EQUIPMENT WASH

- Concentrated professional grade formula powers through vehicle buildup, dirt, and grease with a spot-free rinse. Treat up to 32 gals. Biodegradable.
- » 3.8 L • 2830417
- » 19 L • 2830422

### HD CLEANER & DEGREASER

- Professional-grade, biodegradable, high-foaming formula dissolves and removes tough stains and soils.
- » 3.8 L • 2830418
- » 19 L • 2830420



COOL



Moisture Wicking



Moisture Transportation



Regulated Evaporation

#### TENACITY HELMET

- Injection-molded plastic
- 1450 grams
- 14 intake and 8 exhaust vents for airflow
- DOT and ECE Certified
- » 2868624 • PINK XS-2XL

#### COOLING SHIRTS

- 100% Poly, chemical free patented fabric from CoolCore®
- Moisture wicking to keep you dry
- Moisture transportation to keep you cool
- UPF 45+
- » MEN'S • 2868753 GRAY/ORANGE • S-3XL
- » WOMEN'S • 2868755 GRAY/PINK • S-3XL

#### 509° KINGPIN GOGGLE

- Quick-change lens technology
- Contoured triple layer foam
- Premium anti-fog & anti-scratch coatings
- » 2868668 • ORANGE ONE SIZE

#### 509° ALTITUDE CARBON HELMET

- Carbon fiber shell
- 1100 grams
- Fidlock magnet closure
- 8 intake/exhaust vents for airflow
- DOT and ECE2205 Certified
- » 2867814 • BLACK MATTE S-4XL

#### MEN'S SOFTSHELL JACKET

- Lined with 280 grams of fleece for warmth
- Removable hood
- Pit zips for venting
- » 2868514 • BLACK S-3XL



STAY

KEEP YOUR



#### 509° ALTITUDE HELMET

- Thermo Poly alloy shell
- 1260 grams
- 8 intake/exhaust vents for airflow
- DOT and ECE2205 Certified
- » 2868539 • LIME S-4XL

#### ORV RIDING JERSEY

- 100% Poly
- Side mesh panels for venting
- » 2868711 • BLUE/LIME S-3XL

#### ORV RIDING GLOVES

- Lycra panels provide flexibility in grip
- Soft flex graphics on knuckles for protection
- Lightly padded palm for comfort
- Machine washable
- » 2868712 • BLUE/LIME S-3XL

#### FORCE HELMET

- Injection-molded plastic
- 1380 grams
- 11 intake and 4 exhaust vents for airflow
- DOT Certified
- » 2868839 • BLUE XS-2XL

#### MID LAYERS

- Flexible pill-resistant poly fleece
- Ideal for layering or on it's own
- » MEN'S • 2868512 BLACK • S-3XL
- » WOMEN'S • 2868516 BLACK • S-3XL



WARM



**WOMEN'S RZR® VAPOR HOODIE**

» 2868726 • BLUE  
S-3XL



**WOMEN'S RZR® FULL ZIP HOODIE**

» 2868722 • BERRY  
S-3XL  
AVAILABLE IN YOUTH

**WOMEN'S RZR® CHEEKY TEE**

» 2868774 • BURGUNDY HEATHER  
S-3XL

**MEN'S RZR® SOCIAL CAP**

» 2867892 • GRAY  
ONE SIZE

**MEN'S RZR® FULL ZIP HOODIE**

» 2868719 • GRAY  
S-3XL  
AVAILABLE IN YOUTH



**MEN'S RZR® CLASSIC TEE**

» 2868764 • RED  
S-3XL



**MEN'S RZR® MUD TEE**

» 2868766 • BLUE  
S-2XL

**MEN'S RZR® VAPOR HOODIE**

» 2868717 • BLUE  
S-3XL

**MEN'S RZR® DUNE TEE**

» 2868763 • BLUE  
S-3XL

**MEN'S RZR® MOUNTAIN SCENE CAP**

» 2868740 • BLACK • ONE SIZE



**WOMEN'S RZR® DUNE TEE**

» 2868775 • NAVY HEATHER • S-3XL

**MEN'S RZR® 4-SCENE TEE**

» 2868794 • CHARCOAL • S-3XL

**MEN'S RZR® LOGO CAP**

» 2867889 • RED  
S/M  
» 2867969 • RED  
L/XL

**MEN'S RZR® EDGE TEE**

» 2868762 CHARCOAL  
S-3XL

**WOMEN'S RZR® TRAIL TEE**

» 2868772 • NAVY HEATHER  
S-3XL



**WOMEN'S RZR® DUNE SCAPE HOODIE**

» 2867897 • BLACK • S-2XL



**RZR® PINT GLASSES**

» 2866266

**RZR® WATER BOTTLE**

» 2866313 • BLACK

**RZR® TOYS**

» 2866268 • BLUE  
» 2866269 • WHITE  
» 2868637 • ORANGE







**CAMO TRUCKER CAP**

» 2868750 • CAMO ONE SIZE •

**HUNTER HOODIE**

» MEN'S • 2868716 OLIVE HEATHER S-3XL  
 » WOMEN'S • 2868721 [NOT SHOWN] • OLIVE HEATHER S-3XL

**CAMO HOODIE**

» WOMEN'S • 2867898 • CAMO • S-3XL  
 » MEN'S • 2867879 [NOT SHOWN] CAMO • S-3XL



**'MERICA RETRO CAP**

» 2867757 • BLUE/RED • ONE SIZE

**MEN'S RETRO TEE**

» 2868571 • GRAY • S-3XL

**WOMEN'S RETRO CAP**

» 2868617 • GRAY • ONE SIZE

**WOMEN'S 3/4 BASEBALL TEE**

» 2868584 • GRAY/PINK • S-3XL



**MEN'S RETRO LOGO HOODIE**

» 2868577 • GRAY • S-3XL



**MEN'S ROSEAU HOODIE**

» 2868576 • OLIVE S-3XL

**WOMEN'S RETRO HOODIE**

» 2868592 • BERRY S-3XL



**WOMEN'S ASYMMETRICAL HOODIE**

» 2868596 • BERRY S-3XL

**WOMEN'S V-NECK SCRIPT TEE**

» 2868588 • GRAY S-3XL



**HEX CAP**

» 2867766 • BLACK • ONE SIZE

**MEN'S EST TEE**

» 2868570 • BLACK • S-3XL

**MEN'S HEX TEE**

» 2868568 • NAVY • S-3XL

**WOMEN'S SCRIPT CREW SWEATSHIRT**

» 2868603 • CHARCOAL • S-2XL



**WOMEN'S FULL ZIP RETRO HOODIE**

» 2868595 • CHARCOAL HEATHER S-3XL



**REVERSIBLE CAMO BEANIE**

» 2867756 • ORANGE/CAMO ONE SIZE

**MEN'S CAMO TEE**

» 2868757 • CAMO S-3XL

**MEN'S TEXTILE RIDING JACKET**

» 2867875 • COFFEE S-3XL



**CAMO WATER BOTTLE**

» 2867962

**CAMO COFFEE TRAVEL MUG**

» 2867961

**CAMO BOTTLE KOOZIE**

» 2867964

**CAMO CAN KOOZIE**

» 2867963

**CAMO STEERING WHEEL COVER**

» 2868663

**CAMO BOTTLE OPENER [NOT SHOWN]**

» 2867965



**RETRO CLOCK**

» 2868662

**PINT GLASS SET OF 2**

» 2866265



**WOMEN'S ROSEAU TEE**

» 2868586 • BLACK • S-3XL

**MEN'S MFG CO TEE**

» 2868776 • BLACK • S-3XL