



MY18 PGA GENERAL CAT-INTL - 9930406



POLARIS GENERAL 2018 ACCESSORIES + APPAREL

UNLESS NOTED, TRADEMARKS ARE THE PROPERTY OF POLARIS INDUSTRIES INC. 509 is a registered trademark of 509, Inc. Amara is a registered trademark of Kuraray Co. Ltd. of Japan. AP-360 is a registered trademark of TK. BatteryMinder is a registered trademark of VDC Electronics Inc. Bluetooth is a registered trademark of Bluetooth Sig. Inc. Break-Up is a registered trademark of Haas Outdoors, Inc. Camoplast is a registered trademark of Camoplast Solideal Inc. CREE is a registered trademark of Cree, Inc. FOX is a registered trademark of Fox Factory Inc. GoPro is a registered trademark of GoPro Inc. Homelink is a registered trademark of Johnson Controls Technology Inc. Kevlar is a registered trademark of E.I. du Pont de Nemours & Company. Kolpin is a registered trademark of Kolpin Outdoors, Inc. Maxxis is a registered trademark of Cheng Shin Rubber Ind. Co. Ltd. MB Quart is a registered trademark of Maxxsonics USA Inc. Moose Utility Division is a registered trademark of LeMans Corporation. Mossy Oak is a registered trademark of Haas Outdoors, Inc. MTX is a registered trademark of Mitek Corporation. OGI is a registered trademark of Onjo International, Inc. Rigid is a registered trademark of Rigid Hitch, Inc. Velcro is a registered trademark of Velcro Industries B.V. Ltd Co, Netherlands. Walker Evans is a registered trademark of Walker Evans Enterprises Corp. WARN is the registered mark of Warn Industries, Inc. Yeti is a registered trademark of Yeti Coolers, LLC. YKK is a registered trademark of YKK Corporation. Pro Armor is a registered trademark of Polaris Industries Inc. Prices and availability are subject to change at any moment. Copyright © 2017 Polaris Industries. All rights reserved.

BORN TO OWN
**ANY TASK.
 ANY TRAIL.**



POLARIS
GENERAL

**NO-COMPROMISE
 PERFORMER**

The Polaris GENERAL is a no-compromise breed of side-by-side from the world leader in off-road innovation. You know RANGER® as the world's best-selling utility machines. You know RZR® as the undisputed leader in high performance. We combined the best of both in a single, comfortable machine to make the ultimate rec/utility side-by-side.

POLARIS GENERAL 1000 EPS INDY RED

BASE



- 100 HP PROSTAR® ENGINE
- STANDARD HALF DOORS
- ELECTRONIC POWER STEERING (EPS)
- ENGINE BRAKING SYSTEM (EBS)
- POLARIS® LOCK & RIDE® COMPATIBLE
- VERSATRAC TURF MODE

POLARIS GENERAL 1000 EPS RADAR BLUE

PREMIUM



- BASE PLUS:**
- AUTOMOTIVE PAINT
 - MATTE BLACK CAST ALUMINUM WHEELS
 - 27" MAXXIS® CORONADO TIRES
 - SPORT LOW PROFILE FRONT BUMPER
 - POLARIS® HD 4500 LB (2014 KG) WINCH

POLARIS GENERAL 1000 EPS TITANIUM METALLIC

DELUXE



- PREMIUM PLUS:**
- FOX® PODIUM X 2.0 QS3 SHOCKS
 - POLARIS® LOCK & RIDE® SPORT ROOF
 - MTX® PREMIUM SOUNDBAR
 - CONVEX REAR VIEW MIRROR

POLARIS GENERAL 4 1000 EPS RIDE COMMAND® EDITION BLACK PEARL

PREMIUM



- PREMIUM PLUS:**
- 4 SEATS
 - PREMIUM WALKER EVANS® BULB SHOCKS
 - 27" DIRT COMMANDER 8-PLY TIRES
 - FOX® PODIUM 2.0 QS3 SHOCKS

POLARIS GENERAL 1000 EPS HUNTER EDITION

PREMIUM



- PREMIUM PLUS:**
- LOCK & RIDE® GUN MOUNT/SCABBARDS

POLARIS GENERAL 1000 EPS RIDE COMMAND® MATTE SUNSET RED

PREMIUM



- PREMIUM PLUS:**
- RIDE COMMAND® SYSTEM
 - FOX® PODIUM X 2.0 QS3 SHOCKS
 - POLARIS® LOCK & RIDE® SPORT ROOF
 - MTX® PREMIUM SOUNDBAR
 - CONVEX REAR VIEW MIRROR

POLARIS GENERAL 1000 EPS LE

PREMIUM



- PREMIUM PLUS:**
- CUSTOM MATTE SAGEBRUSH GREEN PAINT / GRAPHICS
 - CUSTOM CUT & SEW SEATS
 - POLARIS® LOCK & RIDE® HEADACHE RACK

**2018
 POLARIS GENERAL
 ACCESSORIES**

- 02 WORK & PLAY
- 12 CAB ACCESSORIES, RIDE COMMAND® & AUDIO
- 18 STORAGE & POLARIS NORTHSTAR® COOLER
- 28 OIL & LUBRICANTS
- 04 POLARIS ENGINEERED™
- 14 LIGHTING
- 20 WHEELS & TIRES
- 30 GARAGE
- 08 WINDSHIELDS & REAR PANELS
- 16 PROTECTION & STORAGE
- 26 WINCHES & PLOWS
- 38 APPAREL
- 10 ROOFS & DOORS

SEE POLARIS ENGINEERED™ VIDEOS AT POLARIS.COM/GENERAL





WORK FASTER

BUILT FOR THOSE WHO TAKE PRIDE IN BEING READY FOR ANYTHING. The Polaris GENERAL is the most do-it-all side-by-side in the industry, and with Polaris Engineered Accessories™ designed to meet your every need, the best gets even better. Build it to suit your needs, and work faster.



RIDE HARDER

THE ULTIMATE REC/UTILITY SIDE-BY-SIDE. The Polaris GENERAL is ready for adventure and to devour the toughest of trails. Before you head out to your favorite trail-head, equip yourself with Polaris Engineered Accessories™ to make a day on the trail even better.

ACCESSORIES ON MACHINE

- A LOCK & RIDE SPORT ROOF - POLY P. 10
- B LOCK & RIDE REAR PANEL - POLY P. 09
- C LOCK & RIDE FULL WINDSHIELD - HARD COAT POLY P. 08
- D ZIP WINDOW UPPER DOORS - CANVAS P. 10
- E LOCK & RIDE CARGO BOX P. 18
- F LOCK & RIDE BED EXTENDER P. 17
- G PRO ARMOR® DUAL-THREAT TIRES P. 20-21

ACCESSORIES ON MACHINE

- A HINGED WINDOW FULL DOORS - POLY P. 11
- B LOCK & RIDE REAR PANEL - GLASS P. 09
- C LOCK & RIDE FULL WINDSHIELD - GLASS P. 08
- D LOCK & RIDE PREMIUM ROOF - POLY P. 10
- E LOCK & RIDE BED EXTENDER P. 17
- F RIGID® 25 cm LIGHT BAR P. 14
- G LOW PROFILE STEEL ROCK SLIDERS P. 16

PERFORMANCE STEMS FROM **INTEGRATION** AT THE START

Ensuring Polaris Engineered Accessories™ fit and work in sync with your machine is the most critical phase of testing and validation. With seamless integration, you can trust that any Polaris® accessory you install will enhance your interaction beyond your expectations.

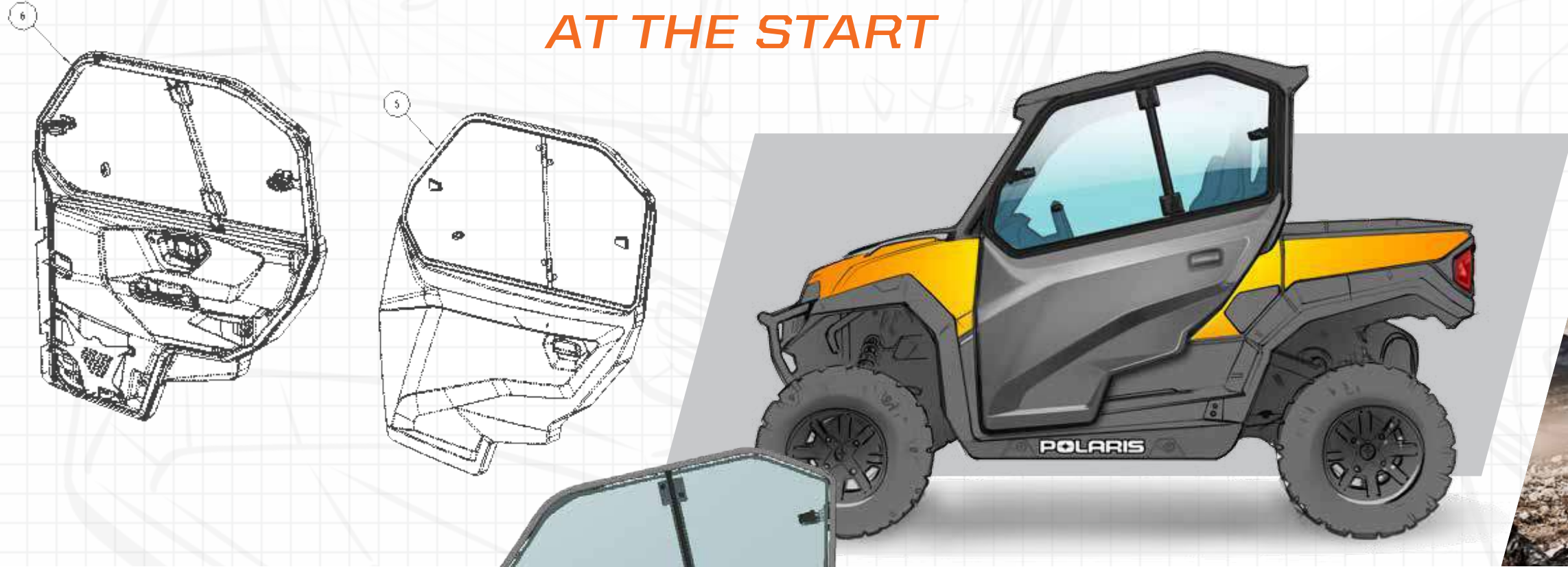

DESIGNED

Only Polaris Engineered Accessories™ are conceived, designed, and fabricated in lockstep with the Polaris GENERAL development process. As the vehicle progresses from concept to production, so do the accessories – this ensures a perfect fit and optimal performance.

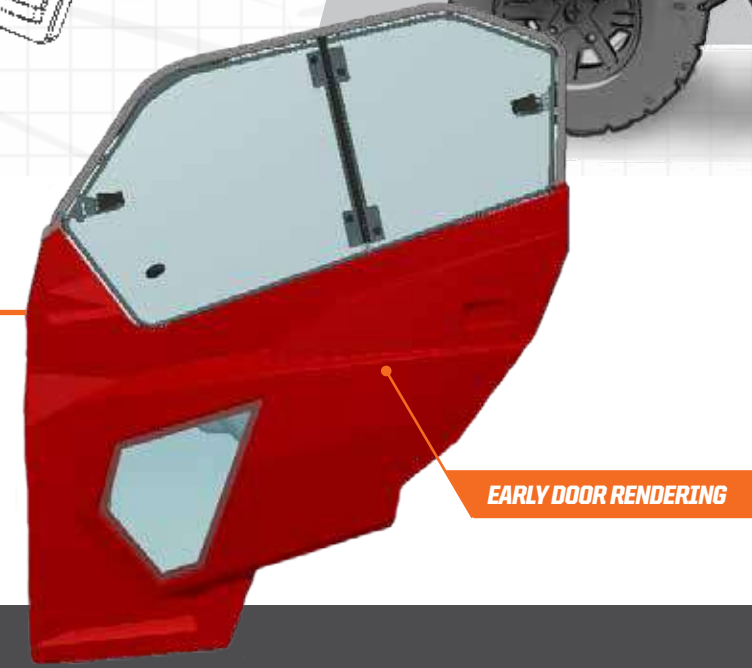

EARLY DOOR RENDERING

TESTED

The Polaris® testing process is rigorous and unforgiving. We put every vehicle and accessories through extreme-use conditions both in the lab and in the field – in all environments, in locations spanning the continent. If it doesn't pass our standards, it's not ready for your Polaris® vehicle. Only the best accessories make it to production.

TRUSTED

Developing the best, most premium accessories in the industry is our passion. Only Polaris® can combine decades of industry-leading experience, innovation, and off-road expertise. You can have confidence in your Polaris Engineered Accessories™, because we know the lifestyle and live it every day.

POLARIS® PARTNERS WITH THE BEST

We choose our partners carefully, selecting only the best in off-road. Every accessory is rigorously tested and validated at Polaris® standards, to ensure seamless integration and performance.



KOLPIN
OUTDOORS
HUNTING ACCESSORIES p.18



PRO ARMOR
WHEELS & TIRES p.20
LED LIGHTS p.14

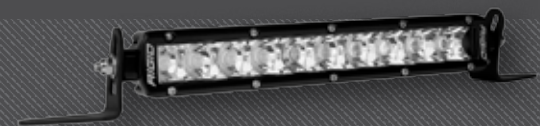

RIGID
LED LIGHTS p.14

ENGINEERED TO TAKE ON THE ELEMENTS

Polaris Engineered™ cab systems keep the outside out. Period. Our cab has 11x better dust sealing than the competition. The exclusive profile tube design of the Polaris GENERAL allows the cab to fit together perfectly, and full 360° gasket seals integrate seamlessly into the frame. Add to this our exclusive Lock & Ride® capability, and you have a cab that outperforms the competition and keeps you comfortable, regardless of the conditions.

TESTED & PROVEN



POLARIS GENERAL CABS PROVIDE THE INDUSTRY'S TIGHTEST SEAL

BUILD YOUR CAB SYSTEM STARTING ON P. 08



PROFILE TUBE DESIGN

Contours built into the cage deliver the best sealing surface in the industry.



PERFECT FIT, PERFECT SEAL

A 360° gasket seal provides the tightest-sealing cab in the industry.



LOCK & RIDE

EASY ON & EASY OFF

Adapt your Polaris GENERAL to your needs and environment with exclusive tool-less, easy-on, easy-off Lock & Ride® components.



A LUXURY OFF-ROAD EXPERIENCE

Our cab components create an experience-enhancing interior, offering supreme comfort to your vehicle.



SHIELD THE FRONT

ATTACK THE SWIRL

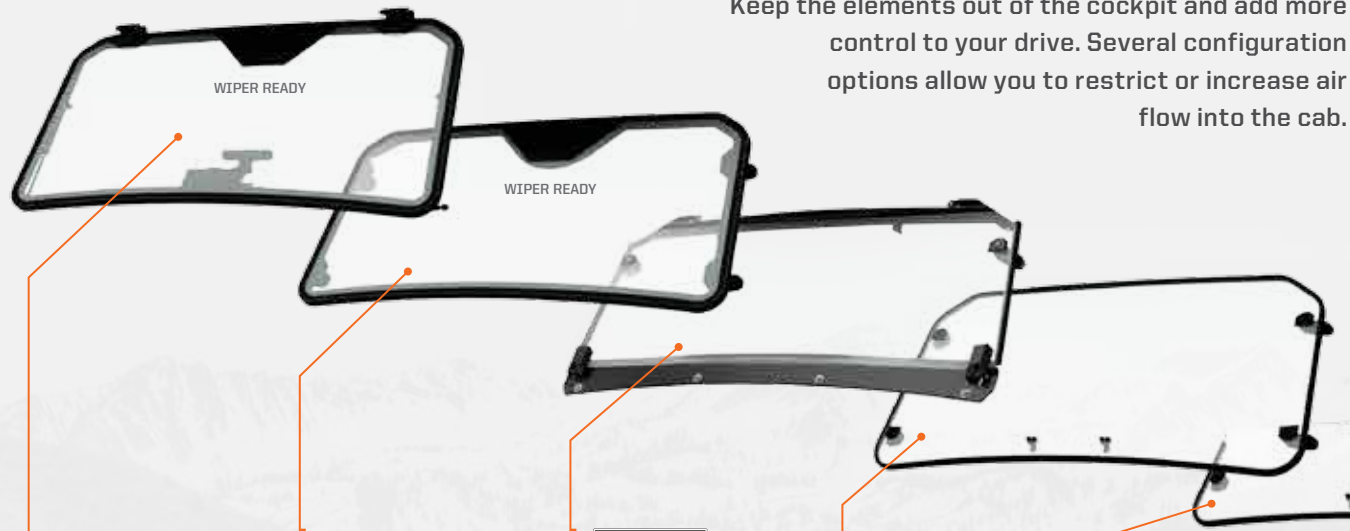

Keep the elements out of the cockpit and add more control to your drive. Several configuration options allow you to restrict or increase air flow into the cab.

Add a windshield to your Polaris GENERAL and experience the airflow changing around the vehicle. For example, turbulent air will form above the cargo bed and behind the cab. This swirl can carry dirt, dust, leaves, and rain into the cab. Eliminate this phenomenon and attack the swirl by mounting a rear panel.

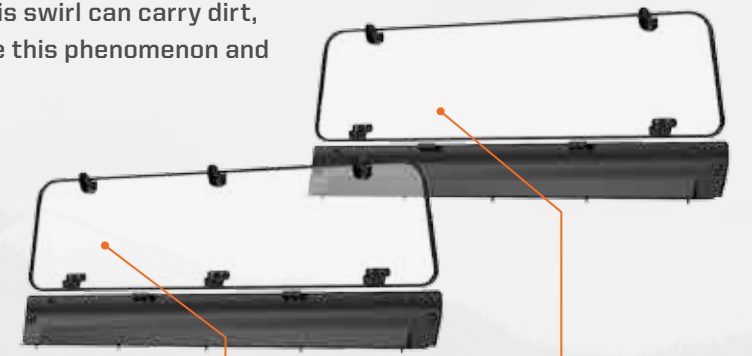

TIP-OUT WINDSHIELD - GLASS

» 2881108
POLARIS GENERAL '16-18,
POLARIS GENERAL 4 '17-18

LOCK & RIDE FULL WINDSHIELD - GLASS TOP SELLER

» 2881109
POLARIS GENERAL '16-18,
POLARIS GENERAL 4 '17-18

LOCK & RIDE FLIP-DOWN WINDSHIELD - HARD COAT POLY

» 2882174
POLARIS GENERAL '16-18,
POLARIS GENERAL 4 '17-18

LOCK & RIDE FULL WINDSHIELD - HARD COAT POLY

» 2881110
POLARIS GENERAL '16-18,
POLARIS GENERAL 4 '17-18

LOCK & RIDE HALF WINDSHIELD - POLY

» 2881111
POLARIS GENERAL '16-18,
POLARIS GENERAL 4 '17-18

LOCK & RIDE REAR PANEL - GLASS TOP SELLER

» 2881113
POLARIS GENERAL '16-18,
POLARIS GENERAL 4 '17-18

LOCK & RIDE REAR PANEL - POLY

» 2881112
POLARIS GENERAL '16-18,
POLARIS GENERAL 4 '17-18



TIP-OUT WINDSHIELD - GLASS



The three-position adjustment system easily opens, providing in-cab ventilation to your preference.

FLIP-DOWN WINDSHIELD - HARD COAT POLY



Offers fully-sealed or flipped-down venting options. Upper half detaches to maintain protection with maximum ventilation.

WINDSHIELD WIPER & WASHER SYSTEM



Add for convenience to wiper ready windshields (2881090).



ADD A REAR PANEL TO REDUCE THE DUST SWIRL

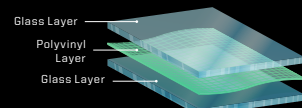

GLASS VS POLY

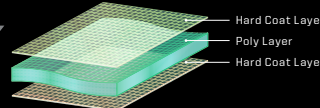

Superior **OPTICAL CLARITY** for a clear view. Laminated safety glass **PROTECTS FROM SCRATCHES** and provides automotive-level visibility.

Curved to fit, seals tight, and is ready for windshield wipers

Lightweight and flexible, POLY is **IMPACT-RESISTANT**, providing long-term value and protection. Guarantees a tight seal to keep out rain and dust.

Available with a hard-coating layer on both sides of the poly, which provides **30X MORE** scratch resistance than regular poly windshields.



AIRTIGHT GASKET SEAL

Our windshields and rear panels feature 360° airtight gasket seals to keep drafts and moisture out of your cab.



LOCK & RIDE

REVOLUTIONARY INSTALLATION

Windshields and rear panels install easily and lock securely in place using Polaris® Lock & Ride® technology. Once installed, it removes easily and can be reinstalled without the need for any tools.

COVERAGE FOR YOUR CAB

A roof represents your best defense against the heat of the scorching sun or a relentless and driving rain, and it is one of the most essential items to mount on your vehicle. Choose from poly or aluminum construction in both 2- and 4-seat configurations.

2-SEAT ROOFS

LOCK & RIDE
PREMIUM ROOF - POLY

» 2881104
POLARIS GENERAL '16-18

INCLUDES
PREMIUM
ROOF LINER

LOCK & RIDE
SPORT ROOF - POLY **TOP SELLER**

» 2881103
POLARIS GENERAL '16-18

ROOF - ALUMINUM

» 2881105
POLARIS GENERAL '16-18



2-SEAT DOORS

ZIP WINDOW UPPER DOORS - CANVAS **NEW**

- Added protection and comfort for all riders
- Durable, rugged canvas stitched over a robust steel frame
- Lightweight, UV-resistant construction
- Retention straps for increased strength
- Zipper windows for increased venting options
- Mounts easily by drilling into stock doors (drill hole plugs included)

» 2882548
POLARIS GENERAL '18
Fall Availability

4-SEAT ROOFS

LOCK & RIDE
SPORT ROOF - POLY

» 2881974
POLARIS GENERAL 4 '17-18

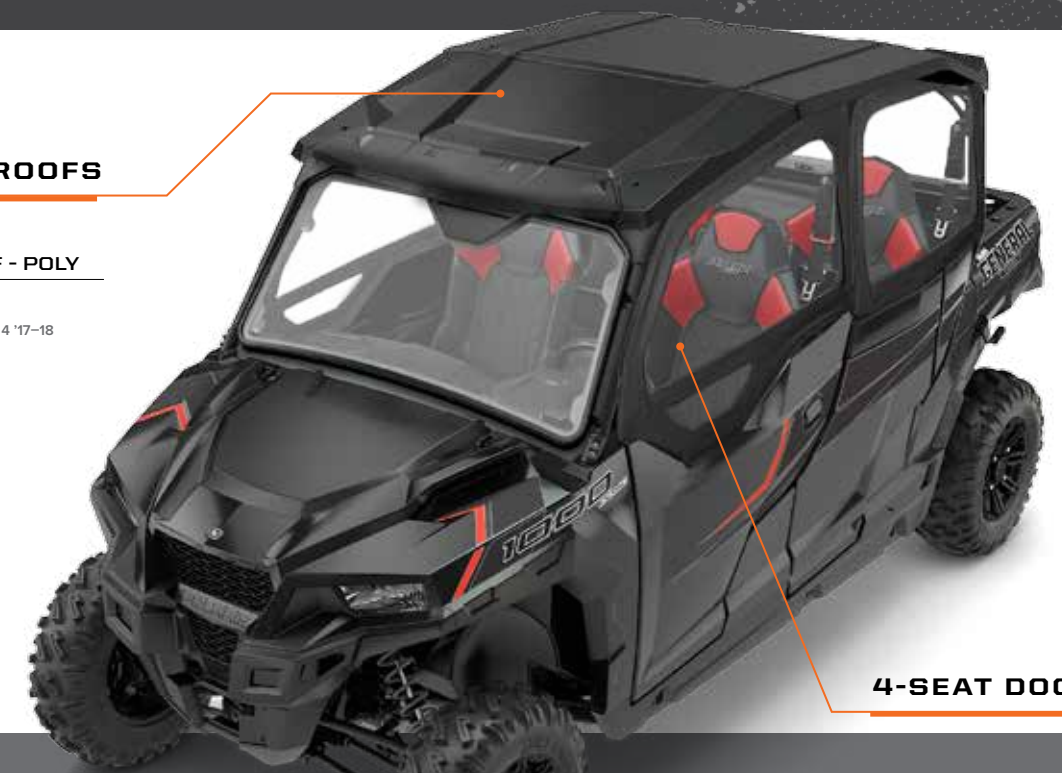

4-SEAT DOORS

ZIP WINDOW UPPER DOORS - CANVAS

- Added protection and comfort for all riders
- Durable, rugged canvas stitched over a robust steel frame
- Lightweight, UV-resistant construction
- Zipper windows for increased venting options
- Mounts easily by drilling into stock doors (drill hole plugs included)

» 2883453
NEW Available Fall 2018
POLARIS GENERAL 4 '18
INCLUDES DOOR
RETENTION STRAPS

» 2882349
POLARIS GENERAL 4 '17

HINGED WINDOW FULL DOORS - POLY **NEW**

- Replaces existing half-door
- Six-way glass window adjustability
- Impact and scratch-resistant tempered glass
- Fully-sealed design keeps elements out for a premium in-cab environment
- 1,500+ Design hours
- 1,200+ On-vehicle validation miles
- Soft-touch interior liner

» 2882528
POLARIS GENERAL '16-18



A PERFECT FIT FOR THE PERFECT SEAL

Polaris Engineered™ cab components nest perfectly into the contours of the cab frame with a 360° degree gasket seal.



KEEP MOISTURE MOVING

Keep precipitation moving with integrated channels that direct water away



TAKE COMPLETE COMMAND

TOMORROW'S OFF-ROAD SOLUTION IS HERE

- KEEP TRACK OF YOUR FRIENDS ON THE TRAIL
- HOLD A CONVERSATION WITHOUT HAVING TO SHOUT
- MONITOR YOUR PHONE WHILE KEEPING IT STOWED
- CONTROL YOUR GOPRO EVEN IF IT'S OUT OF REACH
- TOTAL CONTROL RIGHT AT YOUR FINGERTIPS
- SHARE YOUR RIDE WITH YOUR FRIENDS

POLARIS RIDECOMMAND®

RIDE COMMAND® 7" DISPLAY **NEW**

- Everything you need at the touch of your finger
- Fuel level, coolant temp, battery voltage
- MPH/Km/hr
- Trip 1 / Trip 2
- Buddy Tracking
- Full GPS Capability (w/GPS Puck)
- Bluetooth® Connectivity & AM/FM Stereo Tuner
- Preset Station & Genre
- Save tracks/trails (import/export) via USB or Bluetooth®
- Front and Rear (IR-Lit) Cameras (sold separately)
- GoPro® Integration
- Missed Call/Text Message Icons
- Cell Phone Battery Life Icon
- Cell Phone Signal Strength

» 2882900

POLARIS GENERAL '16-18, POLARIS GENERAL 4 '17-18
▲ Requires a Battery Connection Cable. See pg 13.

RIDE COMMAND® 7" DISPLAY MOUNTING KIT **NEW**

- Mount Ride Command® seamlessly into the dash for perfect fit & finish
- Comes with wiring harnesses needed for Polaris GENERAL and accessory components
- Includes front and rear cameras

» 2882933 • WITH MTX® SOUNDBAR OPTIMIZED FOR RIDE COMMAND®

» 2882934 • WITHOUT MTX® SOUNDBAR OPTIMIZED FOR RIDE COMMAND®

POLARIS GENERAL '16-18, POLARIS GENERAL 4 '17-18

AUDIO

MTX® PREMIUM SOUNDBAR

- Fully-sealed, injection-molded enclosure with marine-grade components
- 100-WATT
- 8 Speakers
- Bluetooth® connections
- Not compatible with Ride Command®

» 2881115

POLARIS GENERAL '16-18, POLARIS GENERAL 4 '17-18
▲ Requires a Battery Connection Cable. See below.

WATCH. RECORD. SHARE.



SIMPLE MENU NAVIGATION

USE THE NAVIGATION BUTTONS TO EASILY CHANGE SETTINGS FOR PHOTOS, VIDEO RESOLUTIONS, EXPOSURE, WHITE BALANCE AND MORE.



INFRARED LIGHTING AT NIGHT PROVIDES INCREASED VISIBILITY



1080P FRONT AND BACK VIDEO CAMERAS

DVR MIRROR

- Installs easily: Mount bolts right into the ROPS of your vehicle
- Neck-saving rear view camera keeps riders in view or assists when backing up
- Hard-mounted wide-angle front camera is adjustable to accommodate viewing height
- Fully-functioning mirror with behind-glass display
- High resolution screen is easy to see in high and low light conditions

» 2881229

POLARIS GENERAL '16-18, POLARIS GENERAL 4 '17-18
▲ Requires a Battery Connection Cable. See below.

» 2879388

POLARIS GENERAL '16-18

» 2879685

POLARIS GENERAL 4 '17-18

▲ A Battery Connection Cable is required for Polaris GENERAL models that do not come stock with a winch for the installation of a winch, and is needed to supply power to the accessory busbar.

8-VENT HEATER & DEFROST SYSTEM

» 2881316

POLARIS GENERAL '16-18, POLARIS GENERAL 4 '17-18
▲ Requires a Battery Connection Cable. See below.

WINDSHIELD WIPER & WASHER SYSTEM

» 2881090

POLARIS GENERAL '16-18, POLARIS GENERAL 4 '17-18
▲ Requires a Battery Connection Cable. See below.

CONVEX REAR VIEW MIRROR

» 2881540

POLARIS GENERAL '16-18, POLARIS GENERAL 4 '17-18

DOME LIGHT

» 2879270

POLARIS GENERAL '16-18, POLARIS GENERAL 4 '17-18

Only fits: Lock & Ride® Roofs (2881103, 2881104 or 2881974)

▲ Requires a Battery Connection Cable. See below.

FLOOR MATS

» 2881934

POLARIS GENERAL '16-18, POLARIS GENERAL 4 '17-18

POLARIS® REMOTE GARAGE DOOR OPENER BY HOMELINK®

» 2882082

POLARIS GENERAL '16-18, POLARIS GENERAL 4 '17-18

▲ Requires a Battery Connection Cable. See below.

INTRODUCING

RIGID®

ADVANCED TECH

Rigid® lights are driven by Aluminum PCB Smart Boards™ with copper thermal conductive pads, gold-plated electrical contacts, 6063-T5 aircraft aluminum extruded housings treated with Alodine® corrosion preventive, and Tiger Drylac® UV protection polyester powder coating.

EXCLUSIVE OPTICS

RIGID® hand-selects the brightest high-tech LEDs from the best manufacturers. The LEDs shine through patented optics that maximize total light output and efficiency. RIGID® lights feature impact-resistant polycarbonate lenses for a 100% water/dustproof seal.

RIGID® LIMITED LIFETIME WARRANTY BREAK YOUR LIGHT AND RIGID® WILL REPLACE OR REPAIR IT FOR LIFE

ADAPT LED LIGHT BARS **NEW**

Adjust the lighting pattern for your needs via the in-dash controller. As your speed changes, you can dial in the light from spot to flood.



MATCH YOUR STYLE

Choose from any color in the spectrum to reflect your style or current mood.

CONTROL FROM THE DASH

A backlit, molded dash controller allows you to control the beam pattern and color.

SR-SERIES LED LIGHT BARS **NEW**

These single-row LED light bars provide a sleek, powerful, low-profile lighting solution that measures less than 5 cm tall. The SR-Series is designed to project light at extreme distances while consuming very little power. Rugged, durable, and ready for anything.

D-SERIES **NEW**

These lights produce extremely high output while consuming very little power. The compact size and shape allow the D-Series LED light to fit almost anywhere and be used for virtually any lighting application.

PRO ARMOR®



LIGHTING

RUGGED STYLING DURABLE CONSTRUCTION

Pro Armor® lights are designed to be big and beefy with an aggressive style all their own. Housed in IP67 marine-grade rated UV Polyester powder-coated with precision-cast end panels and oversized, extruded aluminum heat sinks to keep the temperature down.

MASSIVELY BRIGHT

Counting up to 66 3-5 watt CREE® LEDs pushing over 11,000 lumens, Pro Armor® lights are some of the brightest in the industry. All that power is directed through heat-dissipating aluminum printed circuit boards for streamlined heat management.

DUAL-ROW LED LIGHT BARS

For the most spread and the farthest illumination downrange, Pro Armor® Dual-Row Light Bars are easy to mount and perform beyond expectations. Choose from several lengths and configurations.

SINGLE-ROW LED LIGHT BARS

Powerful and compact, these low-profile light bars look sleek and let you light up the night. Choose from several lengths and configurations to extend your ride.

CUBE LED LIGHTS

Small and powerful, these cube lights can be mounted in strategic locations for added lighting.

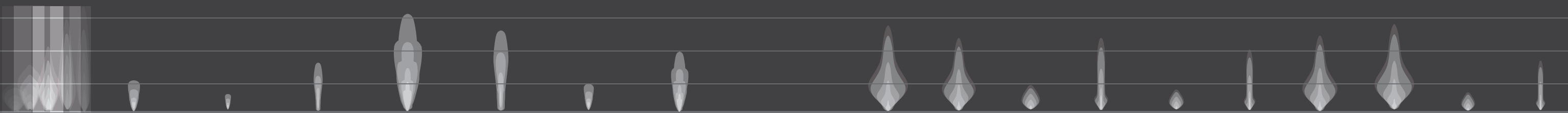

25 cm ADAPT	D-SERIES DRIVING	D-SERIES FLOOD	D-SERIES SPOT	SR-SERIES 81 cm	SR-SERIES 25 cm SPOT	SR-SERIES 25 cm FLOOD	SR-SERIES 25 cm COMBO	DUAL-ROW 76 cm COMBO	DUAL-ROW 51 cm COMBO	DUAL-ROW 25 cm FLOOD	DUAL-ROW 25 cm SPOT	SINGLE-ROW 28 cm FLOOD	SINGLE-ROW 28 cm SPOT	SINGLE-ROW 84 cm COMBO	SINGLE-ROW 102 cm COMBO	DUAL-ROW CUBE FLOOD	DUAL-ROW CUBE SPOT	
RAW LUMENS: 7360	RAW LUMENS: 4752	RAW LUMENS: 3168	RAW LUMENS: 3168	RAW LUMENS: 2064		RAW LUMENS: 7920	RAW LUMENS: 7920	RAW LUMENS: 7920	RAW LUMENS: 11250	RAW LUMENS: 9000	RAW LUMENS: 3020	RAW LUMENS: 3060	RAW LUMENS: 1660	RAW LUMENS: 1600	RAW LUMENS: 5350	RAW LUMENS: 7000	RAW LUMENS: 1300	RAW LUMENS: 3060
2883125	2883128	2883126	2883127	2883124	2883121	2883122	2883123	2882074	2883107	2882311	2882075	2882313	2882078	2882077	2882763	2882312	2882076	
Available Fall 2018	Comes in a pair	Comes in a pair	Comes in a pair															

TRAILBLAZER HEADLIGHT COLORED BEZEL

POLARIS GENERAL® '16-18,
POLARIS GENERAL 4 '17-18

COLOR 2-PACK*

RED (SHOWN)	2882479-293
WHITE	2882479-133
RAW	2882479
BLUE	2882479-689



TRAILBLAZER LED HEADLIGHTS

- Adjustable beam pattern (outer two lights) allows for customized light patterns, from spot to flood, based on riding style and preference
- Integrated LED daytime running light
- 6,000 Lumen total output; 20-watt CREE® XHP LED Chips
- Durable construction is waterproof, dustproof, and fade resistant

» BLACK BEZEL • 2882073
POLARIS GENERAL® '16-18, POLARIS GENERAL 4 '17-18

WIRING HARNESSES REQUIRED FOR RIGID® & PRO ARMOR® LIGHT INSTALLATION

- Add a Battery Connection Cable (2879388 Polaris GENERAL or 2879685 Polaris GENERAL 4) for Polaris GENERAL models that do not come stock with a winch
- For each light with a switch, add 2879859 (LED Light Bar Harness)
- To power two LED Lights from one switch, add 2879860 (Y-harness adapter) to 2879859



INTEGRATED WIRING CHANNELS

With channels and mounting locations designed into the cab frame, installation is a snap, and your wiring stays clean and protected.

* If RIGID® determines, in its sole discretion, that your product is defective in material or workmanship, RIGID® will honor your warranty claim. In some cases the product will be replaced, depending on the specific timeframe of the purchase. If the product is repaired, all parts, labor, and return shipping may be covered by RIGID®.

TAKE ON THE TERRAIN

Arm your Polaris GENERAL with these essential accessories and take on all challenges with Polaris Engineered™ bumpers and guards. Engineered for easy, secure installation; providing added protection for lights, bodywork and suspension.



BUMPERS

A SPORT LOW PROFILE FRONT BUMPER

» 2881094
POLARIS GENERAL '16-18,
POLARIS GENERAL 4 '17-18

B SPORT UPPER FRONT BUMPER

» 2881525
POLARIS GENERAL '16-18,
POLARIS GENERAL 4 '17-18

SPORT REAR BUMPER

» 2881095
POLARIS GENERAL '16-18,
POLARIS GENERAL 4 '17-18

A-ARM GUARDS

HMW A-ARM GUARDS - FRONT

» 2880274
POLARIS GENERAL '16-18,
POLARIS GENERAL 4 '17-18

HMW A-ARM GUARDS - REAR

» 2880171
POLARIS GENERAL '16-18,
POLARIS GENERAL 4 '17-18

ROCK SLIDERS / NERF BARS

EXTREME KICK-OUT STEEL NERF BARS

» 2-SEAT • 2881101
POLARIS GENERAL '16-18

» 4-SEAT • 2881992
POLARIS GENERAL 4 '17-18

LOW PROFILE STEEL ROCK SLIDERS NOT SHOWN

» 2881102
POLARIS GENERAL '16-18

EXPANSION ANCHOR MOUNTS

TOUGH EXPANSION ANCHOR MOUNTS DESIGNED FOR POLARIS GENERAL ALLOW FOR QUICK INSTALL OF ROCK SLIDERS AND BUMPERS WITHOUT DAMAGING THE VEHICLE'S FRAME.

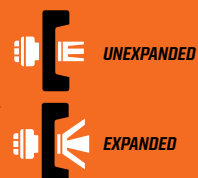

UNEXPANDED

EXPANDED

LOCK AND LOAD IT ALL

PROTECTION & STORAGE



FRONT HOOD STORAGE RACK

» 2882149
POLARIS GENERAL '16-18,
POLARIS GENERAL 4 '17-18

LOCK & RIDE
BED EXTENDER

» 2881547
POLARIS GENERAL '16-18, POLARIS
GENERAL 4 '17-18

LOCK & RIDE
TIP-DOWN
HEADACHE RACK

» 2882144
POLARIS GENERAL '16-18,
POLARIS GENERAL 4 '17-18

CARGO BED MAT

» 2881933
POLARIS GENERAL '16-18, POLARIS
GENERAL 4 '17-18



LOCK & RIDE SPARE TIRE CARRIER

» 2881529
POLARIS GENERAL '16-18, POLARIS GENERAL 4 '17-18



BEHIND SEAT STORAGE BAG

» 2882164
POLARIS GENERAL '16-18



IN-DASH STORAGE BAG

» 2882165
POLARIS GENERAL '16-18,
POLARIS GENERAL 4 '17-18

FIRE EXTINGUISHER HOLDER NOT SHOWN

» 2882158
POLARIS GENERAL '16-18,
POLARIS GENERAL 4 '17-18
Fits most Bcm fire extinguishers
(not included)



WITH THE FLIP OF A LEVER, LOCK & RIDE™ PLUNGERS USE DOWNWARD PRESSURE TO EXPAND FOR A SECURE FIT.

LOCK & RIDE™

AVAILABLE ON ALL POLARIS® VEHICLES, LOCK & RIDE™ ACCESSORIES ALLOW FOR A QUICK RECONFIGURATION BETWEEN WORK AND ADVENTURE





Ample storage with multiple openings for ease & convenience



For customizable storage add a Softside Cooler, Trail, or Tool Bag into the XL Storage Box



A LOCK & RIDE CARGO BOX

» 2881527
POLARIS GENERAL '16-18,
POLARIS GENERAL 4 '17-18

B LOCK & RIDE XL STORAGE BOX

» 2881128-070
POLARIS GENERAL '16-18,
POLARIS GENERAL 4 '17-18

C LOCK & RIDE D-RINGS

» 2881545
ALL POLARIS GENERAL MODELS

D XL TOOL BAG

» 2881129
ALL POLARIS GENERAL MODELS

E XL SOFTSIDE COOLER

» 2881428

F XL TRAIL BAG

» 2881130

G XL POLARIS PURSUIT® CAMO RANGE BAG

» 2881131

H LOCK & RIDE DUAL-GUN SCABBARD MOUNT

» 2881528
POLARIS GENERAL '16-18,
POLARIS GENERAL 4 '17-18

LOCK & RIDE SINGLE-GUN SCABBARD MOUNT (NOT SHOWN)

» 2881747
POLARIS GENERAL '16-18,
POLARIS GENERAL 4 '17-18

I POLARIS® GUN BOOT® BY KOLPIN®

» 2872677 • BLACK
POLARIS GENERAL '16-18,
POLARIS GENERAL 4 '17-18
» 2872677-419 • CAMO
POLARIS GENERAL '16-18,
POLARIS GENERAL 4 '17-18

J POLARIS® SXS CAMO FIELD COVER

» 2882160
POLARIS GENERAL '16-18,
POLARIS GENERAL 4 '17-18

K RATCHETING RHINO GRIP® BY KOLPIN®

» 2881575
ALL POLARIS GENERAL MODELS

L RHINO GRIP® XL BY KOLPIN®

» 2881574
ALL POLARIS GENERAL MODELS

M RUBBER STRAPS

» 2881621

N TIE-DOWN RATCHET STRAPS

» RED • 2859047-01
» BLACK • 2859047-02

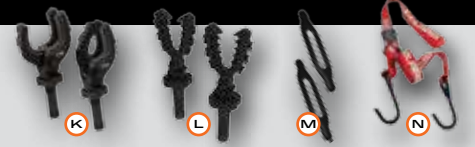

KEEP IT ICE COLD

Polaris Northstar® coolers survive just about anything - from extreme heat to a full-on bear attack. Ice will stay cold for hours on end, and anything inside will stay locked up tight.



28, 57, 99
LITER FEATURES

ComfortCarry Handles	TravelLock System	EasyOut Drain System	NoSlip Rubber Feet	PolarWall Insulation 5 CM	IceLock Seal
Carry a fully loaded cooler with comfort and ease	Integrated tie-down cleats easily secure to any off-road vehicle, boat, or truck	Large, easy-to-open plug for rapid draining	Firm placement on any surface	Thick 5 cm insulation ensures premium cooling	Airtight gasket along the lid keeps cold air in

POLARIS NORTHSTAR® COOLER

- 99 LITER
» GRAPHITE • 2883426
» DESERT • 2883392
- 57 LITER
» GRAPHITE • 2883425
» DESERT • 2881259
- 28 LITER
» GRAPHITE • 2883424
» DESERT • 2881315
- 19 LITER
» GRAPHITE • 2883390
- TUMBLERS
» 887 ml • 2883394
» 591 ml • 2883393

POLARIS NORTHSTAR® COOLER ACCESSORIES



WIRE BASKET
» 2882185 • 58 LITER • **SHOWN**
» 2882438 • 28 LITER

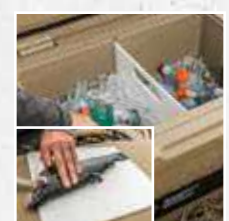

DIVIDERS
» 2882184 • 58 LITER
SHOWN
COMES WITH TWO DIVIDERS
» 2882186 • 28 LITER
COMES WITH ONE DIVIDER



Divider doubles as a cutting board



SEAT CUSHION
» 2882179 • 58 LITER • **SHOWN**
» 2882507 • 28 LITER



COOLER WHEELS
» 2882180 • 58 LITER



BOTTLE OPENER
» 2882183
ALL COOLERS



LOCK & RIDE QUICKSTRAP
» 2882187
ALL COOLERS, POLARIS GENERAL CARGO BOXES



TIE-DOWN STRAPS
» 2859047-01 • RED
ALL COOLERS
» 2859047-02 • BLACK
ALL COOLERS



Polaris® and Pro Armor® developed a deep partnership thanks to having similar histories and passion for producing products that enhance vehicle performance. Each wheel and tire Pro Armor® designs and engineers for Polaris® off-road vehicles perform perfectly in the intended environment for its intended use. Developed, tested, and produced in partnership so you can tackle the terrain ahead.

10-PLY

Pro Armor® builds the toughest tires to keep you running when the terrain turns tough. A higher ply rating means added protection. Choose your tire and ply rating based on use and overall performance needs.

DUAL COMPOUNDS

You don't ride or drive in the same terrain, so Pro Armor® builds certain tires with multiple wear zones. A dual-durometer design allows the tire to wear better with softer outer lugs and harder inner lugs.

4,828 KM RATED

Pile on the miles with Pro Armor® tires. Every tire is designed and constructed with longevity in mind. With ratings of 4,828 kilometers and beyond, you are assured long life and performance.

KNOW YOUR TIRES

DIMENSIONS	TREAD DEPTH	WEIGHT	PLY RATING	SIDEWALL BELTS	LOAD RATING	PADDLE DEPTH
28" x 9" R14 <small>TIRE HEIGHT TIRE WIDTH WHEEL DIAMETER</small>	A deeper tread means more grip and cleaner performance	A lighter tire makes for improved vehicle performance	Indicates the overall load capability of the tire	Sidewall belts increase your resistance to sidewall punctures	Tires with higher load ratings can handle more weight	Increases grip and performance in the sand



TIRE: **DUAL-THREAT** WHEEL: **BUCKLE ACCENT**



PRO ARMOR® DUAL-THREAT **NEW**

- Dual-compound technology and radial construction offer performance in all terrains.
- Softer durometer rubber on outer edge for overall superior grip and feel.
- Harder durometer rubber in the middle for increased traction during acceleration and longer tread life.

- 14" **26" x 9" R14** - FRONT 5416340
- 14" **26" x 11" R14** - REAR 5416341
- 14" **29" x 9" R14** - FRONT 5416342
- 14" **29" x 11" R14** - REAR 5416343

		TREAD DEPTH	TIRE WEIGHT	PLY RATING	SIDEWALL BELTS	LOAD RATING
26R14	FRONT	16mm	12 kg	10	3	413 kg
	REAR		14 kg			503 kg
29R14	FRONT	16mm	14 kg	10	3	503 kg
	REAR		16 kg			599 kg

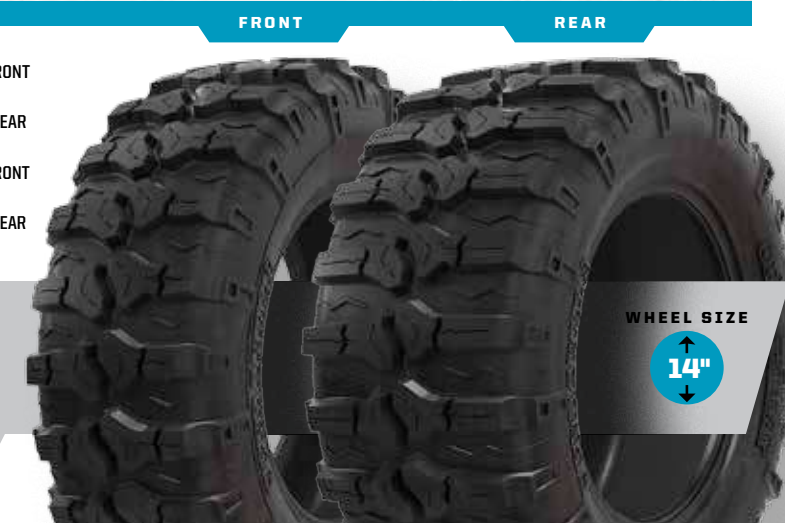

WHEEL SIZE **14"**



PRO ARMOR® ATTACK 2.0 **NEW**

- Engineered for excellent hard-pack performance
- Dual-compound technology and radial construction offer performance in all terrains.
- Tight thread pattern for quieter ride

15" **28" x 10" R15** - FRONT/REAR • 5416344

	TREAD DEPTH	TIRE WEIGHT	PLY RATING	SIDEWALL BELTS	LOAD RATING
FRONT	25mm	15 kg	10	3	504 kg
REAR					



TREAD PATTERN



WHEEL SIZE **15"**

ATTACK 2.0 VS. ATTACK

- **Tighter Tread Pattern** = Better traction in hard pack
- **Dual-Durometer Lug** = Increased grip & traction in rough terrain, smoother ride in all terrain
- **10-Ply Rated** = increased durability
- **Larger size offering in 28"** = more ground clearance & trail traction



PRO ARMOR® ATTACK

- The best all-purpose tire for all-season traction in any terrain
- Unique, full-face tread design
- Harder durometer lugs promote extended wear, increasing tire life
- Wider spaced lugs provide more grip in softer terrain

14" **26" x 9" R14** - FRONT • 5415613
14" **26" x 11" R14** - REAR • 5415614

	TREAD DEPTH	TIRE WEIGHT	PLY RATING	SIDEWALL BELTS	LOAD RATING
FRONT	23mm	13 kg	8	3	413 kg
REAR		15 kg			599 kg



TREAD PATTERN



WHEEL SIZE **14"**

ROCK



FRONT / REAR

PRO ARMOR® CRAWLER XR

- Wanna race? This tire grips it all from the trail to the rocks
- Square block profile for even surface contact
- A tougher durometer than the XG to take on the toughest the trail has to offer

14" 28" x 10" R14 • FRONT/REAR • 5415536

	TREAD DEPTH	WEIGHT	PLY RATING	SIDEWALL BELTS	LOAD RATING	
FRONT	28"R14	16mm	15 kg	8	3	517 kg
REAR						



WHEEL SIZE

14"

SINGLE-DUROMETER

Smaller lug height and single-durometer give this high-speed tire added construction and lateral stability when cornering. Its unique lug design excels in hard-packed, fast terrain.



UTILITY



WHEEL SIZE

14" 12"



PRO ARMOR HARVESTER

- All-around work horse with tread life of 8047 km
- Tread pattern designed to withstand anything from the farm yard, to the pastures to the trail
- With 10-Ply it can carry the load day-in and day-out

14" 28" x 10" R14 **NEW** • FRONT/REAR • 5416347 •
 27" x 10" R14 • FRONT/REAR • 5415965 •
 12" 26" x 10" R12 • FRONT • 5415966 •
 12" 26" x 8" R12 **NEW** • REAR • 5416396 •



WHEEL SIZE

14" 12"



PRO ARMOR PRESERVE **NEW**

- Turf-friendly for areas where low-impact tire tread is needed
- Rounded profile and special tread pattern to limit footprint

14" 27" x 10" R14 • FRONT/REAR • 5416348 •
 12" 26" x 10" R12 • REAR • 5416402 •
 12" 26" x 8" R12 • FRONT • 5416403 •



WHEEL SIZE

12"



PRO ARMOR XD-K

- 26" Aramid fiber-belted tire to tackle any terrain
- Unique full-face tread design
- Harder durometer lugs promotes for extended wear increasing tire life

12" 26" x 9" R12 • 5415756 •
 12" 26" x 11" R12 • 5415757 •



FRONT / REAR

NEW PRO ARMOR® CRAWLER XG

- Big or small, these tires crawl them all
- A soft, sticky compound makes this tire ideal for both rock crawling and desert running
- 8-ply, triple-belted ballistic sidewalls resist punctures

15" 28" x 10" R15 • FRONT/REAR • 5416346

	TREAD DEPTH	WEIGHT	PLY RATING	SIDEWALL BELTS	LOAD RATING	
FRONT	28"R15	20mm	15 kg	8	3	517 kg
REAR						



WHEEL SIZE

15"

DUAL-DUROMETER

With its taller lug height and dual-durometer construction, this tire has the perfect balance between high-speed performance and durability and flex in order to grip slick rock.

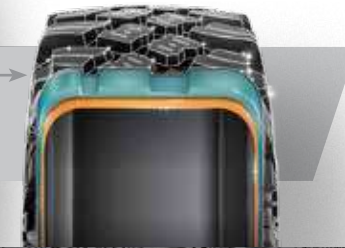

	TREAD DEPTH	WEIGHT	PLY RATING	SIDEWALL BELTS	LOAD RATING
26R12	FRONT	11 kg			388 kg
	REAR	15 kg			599 kg
27R14	FRONT/REAR	15 kg	10	3	599 kg
28R14	FRONT/REAR	15 kg			599 kg

	TREAD DEPTH	WEIGHT	PLY RATING	SIDEWALL BELTS	LOAD RATING
26R12	FRONT	11 kg			388 kg
	REAR	12 kg	10	3	599 kg
27R14	FRONT/REAR	13 kg			599 kg

	TREAD DEPTH	WEIGHT	PLY RATING	SIDEWALL BELTS	LOAD RATING
FRONT	31.7mm	13 kg	8	3/1 Aramid	424 kg
REAR		15 kg			499 kg

DUNES



FRONT

REAR

PRO ARMOR® DUNES

- Lightweight 12-paddle rear tires tout a flexible sidewall for flotation and acceleration
- Three-tiered front tire design delivers hard turning bite and straight-line tracking

14" 28" x 9" R14 • FRONT • 5415533 •
 28" x 11" R14 • REAR • 5415534 •

	TREAD DEPTH	WEIGHT	PLY RATING	SIDEWALL BELTS	LOAD RATING
FRONT	12.8mm	9 kg	8	2	288 kg
REAR	31mm				438 kg



WHEEL HEIGHT

14"

MUD



FRONT

REAR

PRO ARMOR® DAGGER

- From the trails to the pits, this tire gets you through it all
- Deep, self-cleaning lug and wide tire design for exceptional mud pit performance
- Rounded profile and full lug pattern for on-trail comfort

14" 27" x 9" R14 • FRONT • 5415617 •
 27" x 11" R14 • REAR • 5415618 •

	TREAD DEPTH	WEIGHT	PLY RATING	SIDEWALL BELTS	LOAD RATING
FRONT	38mm	15 kg	8	3	499 kg
REAR		18 kg			531 kg



WHEEL SIZE

14"



14" FORGED BEADLOCK RINGS

- Only used on REBLR wheels
- BEADLOCK rings sold individually

- » VOOODOO BLUE 1522244-619
- » MACHINED 1522244-266
- » WHITE 1522244-133
- » INDY RED 1522244-293
- » ORANGE CRUSH 1522244-589

15" FORGED BEADLOCK RINGS

- Only used on HEXLR wheels
- Beadlock rings sold individually

- » BRIGHT WHITE 1522240-133
- » MACHINED 1522240-266
- » INDY RED 1522240-293
- » ORANGE CRUSH 1522240-589
- » VOOODOO BLUE 1522240-619

REPLACEMENT FORGED BEADLOCK RINGS - BLACK

- Only used on combat and halo wheels
- » 14" • 1523146-458
- » 15" • 1523147-458

14" SETS

TIRES	ATTACK 26"	DAGGER 27"	DUAL-THREAT 26"	DUAL-THREAT 29"	DUNES 28"	PRESERVE 27"	HARVESTER 27"	HARVESTER 28"	CRAWLER XR 28"
AMPLIFY Accent	2882390	2882392	2883138	2883146	2882400	2883208	2882388	2883225	2882394
AMPLIFY Matte Black	2882391	2882393	2883139	2883147	2882401	2883209	2882389	2883226	2882395
BUCKLE Accent	2881335	2881337	2883140	2883148	2881345	2883203	2882383	2883220	2881343
BUCKLE Matte Black	2881336	2881338	2883141	2883149	2881346	2883204	2882384	2883221	2881344
COMBAT Accent *BEADLOCKS PRE-MOUNTED			2883217	2883219					2883213
COMBAT Matte Black *BEADLOCKS PRE-MOUNTED			2883216	2883218					2883212
REBLR Matte Black *BEADLOCKS SOLD SEPARATELY	2881381	2881383			2881387				2881386
SHACKLE Accent	2881347	2881349	2883142	2883150	2881357	2883205	2882385	2883222	2881355
SHACKLE Matte Black	2881348	2881350	2883143	2883151	2881358	2883206	2882386	2883223	2881356
SIXR Luster	2881359	2881362							2881371
SIXR Matte Black	2881360	2881363	2883144	2883152	2881375	2883207	2882387	2883224	2881372
SPLIT Matte Black	2881404	2881405	2883145	2883153	2881407				

15" SETS

TIRES	ATTACK 2.0 28"	CRAWLER XG 28"
CYCLONE Accent	2883160	2883188
CYCLONE Matte Black	2883159	2883187
FLARE Accent	2883158	2883186
FLARE Matte Black	2883157	2883185
HALO Accent *BEADLOCKS PRE-MOUNTED	2883162	2883190
HALO Matte Black *BEADLOCKS PRE-MOUNTED	2883161	2883189
HEXLR MATTE BLACK *BEADLOCKS SOLD SEPARATELY	2883154	2883182
WYDE Accent	2883156	2883184
WYDE Matte Black	2883155	2883183

TRACKS

PROSPECTOR PRO® TRACK SYSTEM

- Polaris® exclusive optimized hub geometry that minimizes feedback and eases steering effort
- Flexible lug design provides the highest level of deep snow performance by lifting up in deep snow as opposed to digging down
- Lightweight design with slight weight reduction over Camoplast® kit provides for better flotation, eases steering effort, and provides better vehicle control



PROSPECTOR PRO® TRACK MOUNTS

- Install this track system mounting hardware in place of tires and wheels. Tracks sold separately
- » 2880649 POLARIS GENERAL, POLARIS GENERAL-4

PROSPECTOR PRO® TRACK

- » 2880758 POLARIS GENERAL, POLARIS GENERAL-4

If using Glacier Pro Plow System with tracks, Track Plow Extension is required (2880267)

A AMPLIFY

ACCENT: FRONT 14" x 7" • 1522956-266
REAR 14" x 8" • 1522957-266
MATTE BLACK: FRONT 14" x 7" • 1522956-458
REAR 14" x 8" • 1522957-458

B BUCKLE

ACCENT: FRONT 14" x 7" • 1522544-266
REAR 14" x 8" • 1522545-266
MATTE BLACK: FRONT 14" x 7" • 1522544-458
REAR 14" x 8" • 1522545-458

C COMBAT **NEW**
(BEADLOCK RINGS INCLUDED)

ACCENT: 14" x 7" • 1523284
MATTE BLACK: 14" x 7" • 1523283

D CYCLONE **NEW**

ACCENT: 15" x 7" • 1523184-266
MATTE BLACK: 15" x 7" • 1523184-458

E FLARE **NEW**

ACCENT: 15" x 7" • 1523102-266
MATTE BLACK: 15" x 7" • 1523102-458

F HALO **NEW** (BEADLOCK RINGS INCLUDED)

ACCENT: 15" x 7" • 1523282
MATTE BLACK: 15" x 7" • 1523266

G HEXLR (BEADLOCK RINGS INCLUDED)

MATTE BLACK: 15" x 7" • 1522435-458

H REBLR (REQUIRES BEADLOCK RINGS)

MATTE BLACK: FRONT 14" x 7" • 1522238-458
REAR 14" x 8" • 1522239-458

I SIXR

MATTE BLACK: FRONT 14" x 7" • 1521507-521
REAR 14" x 8" • 1521508-521
LUSTER: FRONT 14" x 7" • 1521507-410
REAR 14" x 8" • 1521508-410

J SHACKLE

ACCENT: FRONT 14" x 7" • 1522546-266
REAR 14" x 8" • 1522547-266
MATTE BLACK: FRONT 14" x 7" • 1522546-458
REAR 14" x 8" • 1522547-458

K SPLIT

MATTE BLACK: FRONT 14" x 6" • 1522542-458
REAR 14" x 8" • 1522543-458

L WYDE

ACCENT: 15" x 7" • 1522550-266
MATTE BLACK: 15" x 7" • 1522550-458

LUGS

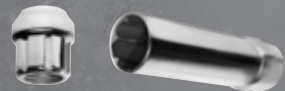

12MM x 1.5 SPLINED LUG NUTS

- » 2879332 • 16 SPLINED LUG NUTS WITH WRENCH ADAPTER
- » 2879331 • 4 SPLINED LUG NUTS WITHOUT WRENCH
- » 2204966 • 12MM X 1.5 SPLINED LUG WRENCH

ALL Polaris GENERAL Models

REPLACEMENT CAPS

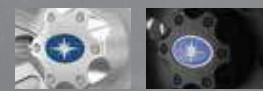

POLARIS® CAPS

- » 1521509-410 • LUSTER
- » 1521509-521 • MATTE BLACK
- AMPLIFY, BUCKLE, COMBAT, CYCLONE, FLARE, HALO, REBLR, SHACKLE, SIXR, SPLIT, WHITEOUT
- » 1522243-410 • LUSTER
- » 1522243-458 • MATTE BLACK
- HEXLR



PRO ARMOR® CAPS

- » 5453209-410 • LUSTER
- » 5453209-458 • MATTE BLACK
- AMPLIFY, BUCKLE, COMBAT, CYCLONE, FLARE, HALO, REBLR, SHACKLE, SIXR, SPLIT, WHITEOUT
- » 1523015-410 • LUSTER
- » 1523015-458 • MATTE BLACK
- HEXLR

DEPENDABLE. TOUGH. BUILT FOR THE OFF-ROAD.

- ✔ Tested **1,200+** pulls at max load, so it works when you need it to
- ✔ Built to withstand **-29° C** temperatures
- ✔ Sealed motor & heavy duty gears
OPERATE FULLY SUBMERGED UNDERWATER
- ✔ **MILITARY** tested & approved

PRO PRO HEAVY DUTY SERIES

Sealed Permanent Magnet Motor

Cut Steel Gears & Sealed Drivetrain

Premium Synthetic Rope

- Superior Flexibility
- Great Strength
- Lightweight & Easy to Handle

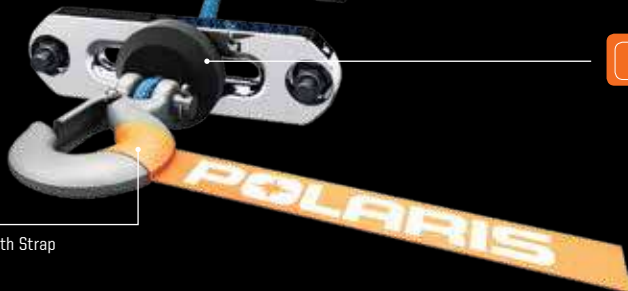

AUTO STOP TECHNOLOGY

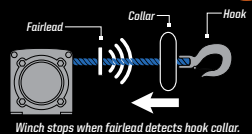

PRO PRO HEAVY DUTY SERIES

POLARIS® PRO HD 4500 LB (2041 KG) WINCH

- » 2881255
- POLARIS GENERAL '16-18, POLARIS GENERAL 4 '17-18
- ⚠ Requires a Battery Connection Cable. See pg 27.

HD HEAVY DUTY SERIES

POLARIS® HD WINCH

- » 4500 LB (2041 KG) • 2881099
- POLARIS GENERAL '16-18, POLARIS GENERAL 4 '17-18
- ⚠ Requires a Battery Connection Cable. See pg 27.
- » 3500 LB (1588 KG) • 2881098
- POLARIS GENERAL '16-18, POLARIS GENERAL 4 '17-18
- ⚠ Requires a Battery Connection Cable. See pg 27.



UPGRADE YOUR HD WINCH WITH THESE ACCESSORIES

POLARIS AUTO-STOP WINCH UPGRADE KIT

- » 4500 LB (2041 KG) • 2881288
- FITS 2881099
- » 3500 LB (1588 KG) • 2881289
- FITS 2881098

SYNTHETIC WINCH ROPE

- » 4500 LB (2041 KG) • 2879187
- » **NEW** 3500 LB (1588 KG) • 2878888

*Woven hook included

POLARIS WIRELESS WINCH REMOTE

- » 2881287
- POLARIS GENERAL '16-18, POLARIS GENERAL 4 '17-18

PUSH FOR MORE

With GLACIER PRO HD Plow Systems, you can attach blades easily and quickly without tools or the need to take your gloves off, thanks to Lock & Ride® technology. Now, you can clear the driveway and get back to what you were doing.



GLACIER PRO HD PLOW SYSTEM

FOR HEAVY-DUTY SNOW REMOVAL

- Heavy-duty cast steel frame for maximum durability
- Lock & Ride®: Install or remove the plow blade quickly and easily
- Manual angle with shear pin design protects plow in high-impact contact
- Manual angle adjustment is easily accessible, prevents digging into snow to change angle
- Auto-retracting kickstand folds in as you drive away

CREATE YOUR GLACIER PRO PLOW SYSTEM

STEP 1 SELECT A MOUNT

- GLACIER PRO HD MOUNT
- » 2881763
- ALL POLARIS GENERAL MODELS

STEP 2 SELECT PUSH FRAME

- GLACIER PRO HD PLOW FRAME
- » 2880260
- ALL POLARIS GENERAL MODELS

PLOWING WITH TRACKS?

- GLACIER PRO HD PLOW EXTENSION
- » 2880267
- REQUIRED TO USE GLACIER PRO PLOW SYSTEM WITH TRACKS

STEP 3 SELECT A LIFT METHOD

- POLARIS® PRO HD 4500 LB (2041 KG) WINCH
- see page 26 for details

- POLARIS® HD 4500 LB (2041 KG) WINCH

- POLARIS® HD 3500 LB (1588 KG) WINCH

STEP 4 SELECT A BLADE

- GLACIER PRO PLOW 168 cm POLY BLADE
- » 2880269
- ALL POLARIS GENERAL MODELS

- GLACIER PRO PLOW 168 cm STEEL BLADE
- » 2880268
- ALL POLARIS GENERAL MODELS

- GLACIER PRO PLOW 183 cm STEEL BLADE
- » **NEW** 2880270
- ALL POLARIS GENERAL MODELS

MAXIMIZE YOUR PLOWING WITH THESE ACCESSORIES

BATTERY CONNECTION CABLE ⚠

- » 2879388
- POLARIS GENERAL '16-18

- » 2879685
- POLARIS GENERAL 4 '17-18

STANDARD WEAR BAR

- » 2879867 • 168 CM
- ALL POLARIS GENERAL MODELS

HD WEAR BAR

- » 2879868 • 168 cm
- ALL POLARIS GENERAL MODELS

- » 2879875 • 183 cm
- ALL POLARIS GENERAL MODELS

⚠ A Battery Connection Cable is required for Polaris General models that do not come stock with a winch for the installation of a winch, and is needed to supply power to the accessory busbar.

- » 2879388
- POLARIS POLARIS GENERAL

- » 2879685
- POLARIS POLARIS GENERAL - 4



SPECIFIC NEEDS, SPECIFIC OILS

Polaris invests millions in engine development, and part of that investment is making sure its lubricants—critical to engine performance—are the right formula for your specific engine. The amount of testing data and engineering resources used in developing Polaris' lubricants would overwhelm an aftermarket company. Therefore, the aftermarket must spec an oil to an industry-wide standard that must account for a variety of operating parameters.

PS-4 is designed specifically for Polaris' 4-cycle engines and has high film strength and wear protection under extreme loads and temperatures. Exclusive anti-wear additives protect engine parts with extra rust and corrosion protection.

PS-4 FULL-SYNTHETIC OIL

• PS-4 is optimal for ambient operating temperatures of -40° C to 38° C

- » 1 L • 2876244
- » 4 L • 2876245
- » 61 L • 2876247
- » 208 L • 2876246
- » 1249 L • 2878814

PS-4 OIL CHANGE KIT

• Contains the correct amount of oil for your vehicle and correct oil filter

- » 2202166 SINGLE 570, TWIN 600, TWIN 700, TWIN 800
- » 2877473 RANGER /RZR 900/1000
- » 2880913 POLARIS ACE /ETX 325
- » 2877473 330-500, SPORTSMAN 550/850/1000

ORV MAINTENANCE KIT

• Includes: 1.4 L AGL, 1 L Angle Drive Fluid, 473 ml Demand Drive Fluid, 384 ml tube of All-Season Grease

- » 2880425

PS-4 EXTREME-DUTY FULL-SYNTHETIC OIL

• PS-4 Extreme Duty is optimal for ambient operating temperatures of -18° C to 54° C

- » 1 L • 2878920
- » 4 L • 2878919
- » 61 L • 2879003
- » 208 L • 2879002
- » 1249 L • 2879001

PS-4 EXTREME-DUTY OIL CHANGE KIT

• Contains the correct amount of oil for your vehicle and correct oil filter

- » 2879004 SINGLE 570, TWIN 600, TWIN 700, TWIN 800
- » 2878924 330-500, SPORTSMAN 550/850/1000
- » 2879324 RANGER /RZR 900/1000
- » 2881697 RZR TURBO

POLARIS® PS-4 VS THE COMPETITION

ULTIMATE ENGINE PROTECTION

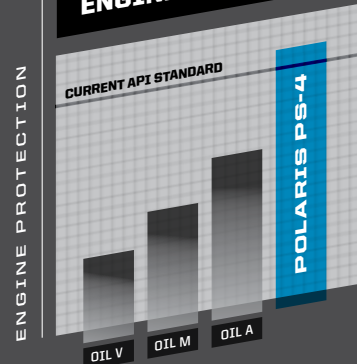

Polaris® PS-4 oils exceed the latest industry protection standard as set by the API, while the competition uses standards from years ago. Our proprietary additives clean and protect critical engine parts under high operating temperatures.

ENGINEERED TO MAXIMIZE THE LIFE OF YOUR RIDE

All Polaris® fluids—from anti-freeze to brake fluid—are developed for your vehicle. Trust the only fluids perfectly engineered for your needs.

AGL

A proprietary blend of additives designed to optimize Polaris® ORV transmission life. Extreme pressure additives protect gears, drive chain, and bearings from scoring and wear. Unlike typical gear case oils, AGL's unique viscosity range allows instant flow and film protection in extreme cold or high heat environments

- » 1 L • 2878068
- » 4 L • 2878069
- » 9.5 L • 2878070
- » 208 L • 2879594



DOT 4 BRAKE FLUID

Polaris® DOT 4 Brake Fluid is a high-quality hydraulic brake designed for use in Polaris® hydraulic brakes. Superior high-temp characteristics plus anti-corrosive additives extend the life of brake system components and provide consistent, positive braking

- » 355 ml • 2872189

ANTI-FREEZE

Polaris® Extended Life Coolant contains organic acid technologies to prevent corrosion on metal components, eliminate scaling, and maximize cooling system performance

- » 1 L • 2880514
- » 4 L • 2880513
- » 208 L • 2880512

DEMAND DRIVE FLUID

Engineered specifically for Polaris® ORV front drive systems. Provides positive 4WD engagement in extreme cold or high heat conditions. Unique friction additives protect internal components under heavy loads and promote positive engagement

- » 1 L • 2877922
- » 9.5 L • 2877923

U-JOINT GREASE

Polaris® U-Joint Grease is a heavy-duty lubricant formulated with molybdenum disulfide to accept the high shock applications of Polaris® ATV shaft drive universal joints

- » 89 ml • 2871515
- » 414 ml • 2871551

Proper lubricant application and timing will ensure optimal vehicle performance. Please refer to your owner's manual for lubricant change interval schedules.

33% MORE CAMSHAFT PROTECTION

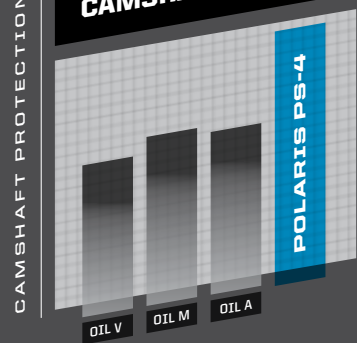

When tested against competitive oils, camshaft bearing races and lobes exhibit less wear when protected by Polaris® PS-4 oil.

LUBE ACCESSORIES



GREASE GUN KIT

- » 2871312

FITS 2871322 ALL-SEASON AND 2871322 U-JOINT 89 ml.

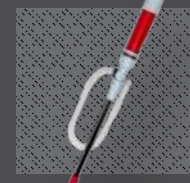

2D BATTERY-OPERATED SIPHON PUMP

• Liquid transfer pumps 5-6 liters/min suctioning power.

• Use with gas, water, oil, and other non-corrosive liquids

- » 2830513



FLEX SPOUT

• Convenient easy pour flex spout fits all Polaris® quart, gallon, and 9.5 liters bottles

- » 2871285



PUMP

- » 2870465

ATTACHES TO 4- OR 9.5-LITERS BOTTLE FOR EASY, NO-D RIP DISPENSING



PREMIUM GAS SHOCK OIL

- » 1 L • 2870995
- » 9.5 L • 2872279

FOX® REBUILDABLE SHOCKS



10WT GAS SHOCK OIL

- » 1 L • 2874124

WALKER EVANS® REBUILDABLE SHOCKS



ANGLE DRIVE FLUID

- » 1 L • 2876160
- » 9.5 L • 2872276

SPORTSMAN®, RANGER®, RZR® ANGLE DRIVE GEAR CASE SYSTEMS



CHAIN LUBRICANT

- » 473 ml AEROSOL 2872348



ALL-SEASON GREASE TUBE

- » 89 ml 2871322
- » 414 ml 2871423

25% BETTER PROTECTION AT HIGH TEMPS

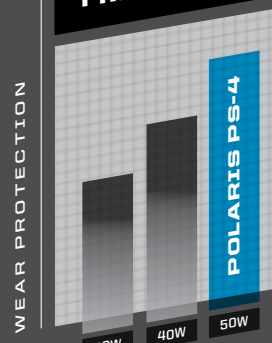

PS-4 delivers 25% stronger viscosity protection for gears, pistons, cams and bearings vs. 40wt. oils

WHY VISCOSITY MATTERS: Polaris® engines are designed to operate using oils rated at a specific viscosity. Viscosity is the measure of an oil's resistance to flow, and shear, and is a way to gauge an oil's "film strength", which is a critical component in preserving engine life when an oil is subject to high heat or heavy loads.



CARBON CLEAN

Polaris® Carbon Clean prevents ethanol corrosion, stabilizes fuel, and cleans fuel injectors, piston ring lands, intake systems, and combustion chambers. Helps maintain peak HP and improves fuel economy

- » 355 ml • 2881413



ADVANCED FUEL TREATMENT

Advanced Fuel Treatment prevents ethanol corrosion and stabilizes fuel for up to 2 years. Dual-antioxidant formula protects against gum and varnish for easy starting

- » 355 ml • 2881416
- » 9.5 L • 2881417



SCENTED ADVANCED FUEL TREATMENT

• 30 ml pouch treats 19 liters of fuel
• Scented formulas provide pleasant fragrance through the exhaust system
• Alcohol free: safe for all powerports applications

- » MINT • 2881418
- » STRAWBERRY • 2881419
- » UNSCENTED • 2881420
- » 25 - 30 ml POUCHES OF EACH FORMULA • 2881421

FOR THE LIFE OF YOUR RIDE

THE KEY TO KEEPING YOUR POLARIS® OFF-ROAD VEHICLE PERFORMING

as well as the day you brought it home is proper maintenance. Items like belts, filters, and batteries represent only a few of these critical items engineered specifically by Polaris®.

CHECK OUT OUR [PARTS FINDER ON POLARIS.COM](https://www.polaris.com) FOR EASY PARTS LOOK-UP, PARTS IDENTIFICATION, VIEWS OF ASSEMBLIES, AND MORE!

POLARIS ENGINEERED™ DRIVE BELTS

Polaris Engineered™ belts deliver unmatched performance for your off-road vehicle. Our belts are developed and tested on all our engines for all environments and conditions. This ensures it doesn't merely fit your vehicle—it outperforms your expectations.



TESTED, PERFECTED

We test each belt on the intended vehicle – we don't try to make an existing belt "just work." The tolerances are tighter than aftermarket alternatives, meaning less heat for your engine, and you won't have to recalibrate your clutch in order to run at the engine's optimal RPM. Aftermarket belts fluctuate in and out of the optimal power band, which means more wear on your clutch and more maintenance needed to maintain power.

OUR INVESTMENT

We average **32,187 km** of field testing and **thousands of dyno hours** on each engine to ensure the Polaris® drive belt on your machine gives you peak performance with each and every ride.

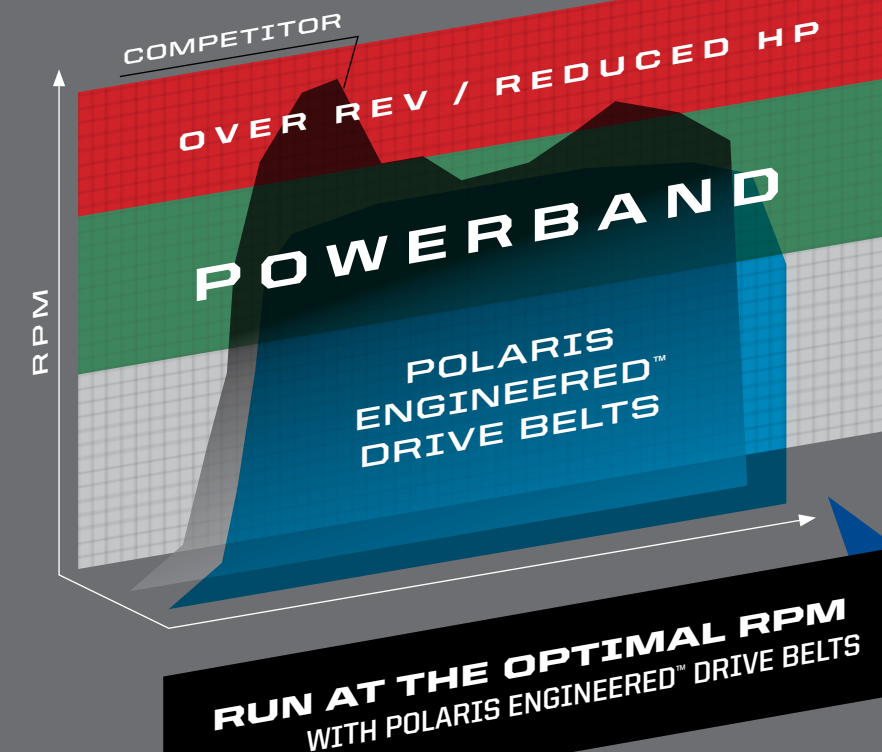

MAINTENANCE SCHEDULE

CHECK YOUR OWNER'S MANUAL FOR ADDITIONAL RECOMMENDED SERVICE ITEMS AND VEHICLE-SPECIFIC TIMING

25 HRS/805 km	100 HRS/1609 km	150 HRS/2414 km	200 HRS/3219 km	350 HRS/5633 km	500 HRS/8047 km
BREAK-IN MAINTENANCE	12 MONTHS	18 MONTHS	24 MONTHS	30 MONTHS	36 MONTHS
ENGINE OIL: CHANGE GENERAL LUBRICATION: ALL FITTINGS, PIVOTS, CABLES, ETC. AIR FILTER: INSPECT & CLEAN REPLACE AS NEEDED	ENGINE OIL: CHANGE DRIVE BELT: INSPECT & ADJUST REPLACE AS NEEDED TRANSMISSION FLUID: CHANGE	ENGINE OIL: CHANGE BATTERY: TEST, CLEAN, & CHECK FLUID LEVEL REPLACE AS NEEDED DRIVE BELT: INSPECT & ADJUST REPLACE AS NEEDED TIRES: INSPECT CONDITION & PRESSURE	ENGINE OIL: CHANGE BRAKE PADS & FLUID: INSPECT & CLEAN REPLACE AS NEEDED SPARK PLUGS: INSPECT REPLACE AS NEEDED	ENGINE OIL: CHANGE BATTERY: TEST, CLEAN, & CHECK FLUID LEVEL REPLACE AS NEEDED DRIVE BELT: INSPECT & ADJUST REPLACE AS NEEDED GENERAL LUBRICATION: ALL FITTINGS, PIVOTS, CABLES, ETC.	ENGINE OIL: CHANGE AIR FILTER: INSPECT, CLEAN REPLACE AS NEEDED COOLANT: CHECK LEVEL REPLACE EVERY 2 YEARS GEARCASES: CHECK OIL LEVEL

POLARIS POWER®

POWERFUL, PORTABLE, DURABLE. These digital inverter generators are built to match your outdoor lifestyle, and are tested to the same rigorous standards as every Polaris® product. The 1000-watt generator is best for running a single device with low wattage requirements. The 2000-watt generator runs multiple devices with added surge protection and start-up wattage. The 3000-watt generator handles high-output needs and runs multiple devices. It also includes electric start for ease of use when needed.

WHICH GENERATOR FITS YOUR NEEDS?

- 1 START** by adding up the running watts of everything you might power at the same time. (use the chart on the left)
- 2 NEXT**, pick the device with the highest running watts, and add its starting watts to the previous total.
- 3 NOW** you have the total amount of watts you need from your generator. Select a generator with a slightly higher wattage.

	Startup Wattage	Running Wattage
140 cm LCD TV	0	150
CROCK POT	0	200
RADIO	0	50-200
LAPTOP	0	200-250
625W MICROWAVE	0	625
FRIDGE OR FREEZER	700	700
COFFEE MAKER	1300	800
SUMP PUMP: ¼ HP	1300	800
BLENDER	1000	1000
ELECTRIC GRIDDLE	0	1500
18 cm CIRCULAR SAW	1700	1400
AIR CONDITIONER	1500	1500



POLARIS POWER® INVERTER GENERATORS

- » 1000 WATT • P136DGNANA
- » 2000 WATT • P136DGBNA
- » 3000 WATT • P136DGCNA



POLARIS POWER® CABLE KIT

- Use a parallel cable kit to easily connect two Polaris Power® generators together to increase the total power available to a load

» 3410281



POLARIS POWER® TIE-DOWN LEADS

- Secure your Polaris Power® Generator by inserting the Lock & Ride® Tie Down Leads into the handle and running a strap across to tie down the generator
- Secures Lock & Ride® accepting gear
- Safely provides a point for 1" wide tie-down strap

» 2880959



POLARIS POWER® COLD WEATHER KIT

- Ensure smooth running of your Polaris® Generator in sub-zero temperatures
- Prevents ice blockage in the crankcase breather tube, which may lead to operational issues including oil leakage
- Installation required, no need to disconnect for warm weather operation
- Exclusively designed for use with Polaris® P1000i & P2000i inverter generators

» 2881433



POLARIS POWER® GENERATOR OIL

Corrosion inhibitors protect against rust and oxidation during long-term storage.

» 1 LITER • 2879383

POLARIS POWER® GENERATOR STORAGE COVERS

- Keep your generator looking like new with a strong, durable cover that is resistant to mold, mildew, tears, and abrasions

» 1000 WATT COVER • 2686441

» 3000 WATT COVER • 2686443

» 2000 WATT COVER • 2686442



POLARIS® FLEX JUMPSTARTER

12,000 mAh capacity. Two 5V/2.1A USB outputs, 200-lumen flashlight and a digital battery life monitor. Includes, storage case, smart jumper cables, car charger, wall charger and user guide. 1-year limited warranty.

» 2830495



Never let a dead vehicle battery slow you down again. The Polaris® Flex Jumpstarter is a compact solution that provides the power to get your ride started. Flex is small enough to be stored in your glovebox and holds its charge so you can count on it when it's needed. In addition to being able to jumpstart ATVs, ORVs, snowmobiles, motorcycles, cars, & trucks, Flex can also charge any USB capable device through its dual USB outlets. Ability to jumpstart up to a 6.4L engine.

BatteryMINDER®

Make sure your vehicle's battery is properly maintained and ready for when you need it the most with a BatteryMINDER®. A tired battery is waiting for the perfect time to ruin your day, so make sure it gets charged and cycled properly. Easily one of the most essential pieces of equipment every garage needs.



BATTERYMINDER® 1510 1.5-AMP

- Recovers weak batteries
- Ambient temperature sensor with wide operating range ensures the battery will never be overcharged or undercharged regardless of temperature extremes
- Extends battery life up to four times when compared to new batteries not being properly charged or maintained over their lifetime
- Automatic full-time high frequency (not high voltage) pulse type desulfation
- Reverse polarity, short circuit and over temperature protection

» 2830404

BATTERYMINDER® 2012 AGM 2-AMP

- Designed for High-Performance Specialty AGM Sealed Batteries
- Guaranteed to never overcharge, regardless of how long connected
- Temperature compensation ensures proper charge in hot or cold environments
- Ambient temperature sensor with wide operating range ensures the battery will never be overcharged or undercharged regardless of temperature extremes
- Maximizes battery life and capacity, reconditions weak batteries

» 2830438

BATTERYMINDER® 1.5 AMP CONVERTIBLE

- BatteryMINDER® 1.5 AMP On-board or Benchtop Charger/Maintainer
- Complete with two mounting brackets for multiple vehicles/locations, fully-insulated battery clips, ring terminal-assembly for permanent direct-to-battery attachment.
- Charges, maintains, recovers 12-volt batteries
- Maintains up to four batteries at a time
- Attaches to battery while in vehicle or for use on benchtop
- Guaranteed to never under or overcharge
- Recovers and reconditions deeply discharged batteries automatically, using high-frequency pulse type desulfation circuitry
- Can extend battery life up to four times

» 2830511

BATTERYMINDER® EZ CONNECT

- Allows for quick and easy connecting and disconnecting of your BatteryMINDER, includes a set of ring terminals

» 2830411

BATTERYMINDER® 4 METER CABLE

- Made with heavy-duty 16 gauge black zip cord featuring automotive SAE bullet connectors

» 2830410

BATTERYMINDER® SPLITTER

- A simple, safe, and affordable way to connect two batteries simultaneously for easy battery maintenance

» 2830409

BATTERYMINDER® RING TERMINAL

- Features 61 cm long 18-gauge wire
- Plug has standard .8 cm negative and .95 cm positive terminals
- Replaceable 15-amp in-line fuse for circuit protection
- Uses SAE quick connector and cap

» 2830437

TOOL STORAGE SOLUTIONS

1

Give your tools a dedicated spot with a properly sized rolling base. Extra-deep drawers are great for storing power tools and bulky items.

CHOOSE YOUR BASE

Raise-and-release drawer pulls keep drawers secure when moving

Drawers use roller-bearing glides

Full-width wrap-around aluminum drawer pulls



POLARIS® 76 cm 5-DRAWER ROLLER CABINET

• 78 cm W × 104 cm H × 52 cm D
» TEXTURED FINISH 2830406*

Two extra-deep drawers allow storage of large and bulky tools



POLARIS® 104 cm 11-DRAWER ROLLER CABINET

• 104 cm W × 105 cm H × 46 cm D
» TEXTURED FINISH 2830408*
» HIGH-GLOSS FINISH 2830451*



POLARIS® 183 cm 19-DRAWER ROLLER CABINET

• 183 cm W × 119 cm H × 64 cm D
» HIGH-GLOSS FINISH 2830492*

Three extra-long drawers provide storage for tools of all shapes and sizes

2

Polaris® offers two types of tops: Portable and permanent.

CHOOSE YOUR TOP



POLARIS® 76 cm PORTABLE WORKSTATION

• 78 cm W × 52 cm H × 44 cm D
» TEXTURED FINISH 2830405*



POLARIS® 104 cm PORTABLE WORKSTATION

• 104 cm W × 55 cm H × 44 cm D
» TEXTURED FINISH 2830407*



POLARIS® 104 cm STANDARD TOP CHEST

• 103 cm W × 52 cm H × 50 cm D
» HIGH-GLOSS FINISH 2830450*



POLARIS® 183 cm STAINLESS STEEL TOP

• 183 cm W × 1.3 cm H × 64 cm D
» 2830496

DON'T FORGET THE FINISHING TOUCHES

3

Complete the organizing with a strategically placed caddy.

UPGRADE



POLARIS POWER® TOOL CADDY

• Hangs from fence rail of roller tool cabinets
» SILVER • 2830430*



POLARIS® HAND TOOL CADDY

» SILVER • 2830431*



POLARIS® BADGES

» RANGER® SHOWN 2830413
» RZR® • 2830412

FINISH YOUR GARAGE



POLARIS® MAGNETIC PARTS TRAY

» SILVER • 2830432

POLARIS® 84 cm TELESCOPIC MAGNET

» BLACK • 2830435

POLARIS® 30 cm HI-TORQUE RATCHETING DRIVER

» BLACK / BLUE • 2830434

POLARIS® LED POCKET FLASHLIGHT

» BLACK • 2830436



POLARIS® HEAVY-DUTY SCRUBBER WIPES

» 90 COUNT 2830441



POLARIS® SHOP TOWELS

» 200 COUNT SHOP TOWEL ROLL WITH DISPENSER SHOWN

2830402 SHOWN
» 200 COUNT REFILL 2830403

» 64 COUNT SHOP TOWEL REFILL • 2830440

NEW



ROLL IT WHERE YOU NEED IT

Inspired by the carts that top racing teams use, this cart offers the best in storage and portability. Whether in the shop or out in the field, your tools go where you need them the most.

TOOL CART

- Rolling design allows for maximum portability
- Multiple-depth drawers securely hold hand tools, power tools, and more
- Large tires for performance in all types of terrain
- Take your tools where you need them easily and securely
- » 79 CM WIDE X 48.6 CM DEEP X 100 CM HIGH 2830512

*Tools not included

ELEVATE YOUR WORK



POLARIS® VEHICLE LIFT

- Get fast, easy access to the underside of your vehicle
- Manual and pneumatic operation available

» 1205 LB (567 KG) 2830424

- Raises vehicle up to 81 cm to make repairs & maintenance faster and easier
- Dual-locking safety latch for added safety

» 2300 LB (1043 KG) 2830425

POLARIS® VEHICLE LIFT ATTACHMENTS

- » RZR / RANGER 2830428
- » ATV/POLARIS ACE 2830427
- » SNOWMOBILE 2830426



POLARIS® X3 CREEPER

- Three positions: flat, 45-degree angle, or seated work stool
- Helps you perform any repair with ease
- Stay dry and warm away from cold, wet cement floors
- Easily stores away when not in use

» BLACK • 2830429

PREMIUM TIRE SEALANT

- Instantly seals and repairs rim, bead leaks, and punctures up to .64 cm on standard tires, and 1.9 cm on heavy ply tires
- Helps maintain air pressure for the life of the tire
- Helps seal the tire bead against the wheel
- 100% water soluble for easy cleanup.
- Will not rust, corrode, or pit wheels
- Creates permanent repair
- Remains fluid and effective in temperatures down to -43° C
- Easily installed through existing tire valve stem with valve core removed

» 1 LITER • 2830484
» 4 LITER • 2830485
» 19 LITER • 2830486

» 19 LITER PUMP • 2830487
» 208 LITER • 2830489
» 1041 LITER • 2830488

HOW IT WORKS

Tire sealant remains liquified inside your tire until some sort of leak develops in the tire or wheel.

Once a leak occurs, the tire sealant rushes out of the tire and quickly creates a permanent solid plug.

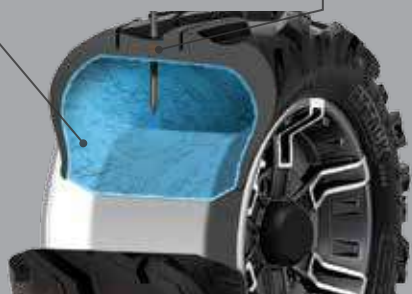

The sealant creates a permanent solid plug and maintains the pressure of the tire so you can continue your ride.

KEEP IT CLEAN

PRE-TREAT

MUD SHIELD® PRE-TREATMENT

- Inhibits the adhesion of dirt, mud, and snow, making cleaning your vehicle faster and easier.
- » 473 ml AEROSOL • 2830208

NEVER RUST SPRAY®

- Synthetic formula highly resistant to water protects against rust and corrosion while lubricating metal surfaces.
- » 473 ml AEROSOL • 2830209

CLEAN

XP WASH®

- Foaming, highly-concentrated wash easily removes the most stubborn and intense dirt build-up.
- » 946 ml

XP SPRAY WASH®

- Effortless biodegradable, high-performance wash ideal for removing dirt, oils and carbon—simply spray on, spray off and go.
- » 946 ml

ALL-PURPOSE CLEANER

- Professional grade, non-streak, foam formula cuts through grease dirt and film leaving an invisible, dirt-resistant barrier for long-lasting results.
- » 473 ml • 2830205

GLASS CLEANER

- Heavy-duty foam non-streak formula cuts through grease, dirt, dried bugs and film leaving a crystal clear dirt-resistant barrier for long-lasting results.
- » 473 ml

SHINE

POLARIS® POLISH

- Easy protection and shine—spray on, wipe off, and go. For ideal use on painted and plastic surfaces. Contains carnauba wax.
- » 473 ml

INSTANT SHINE & DETAILER

- Spray and wipe formula—cleans, polishes, and protects plastic and painted surfaces.
- » 473 ml • 2830204

TRAILERING

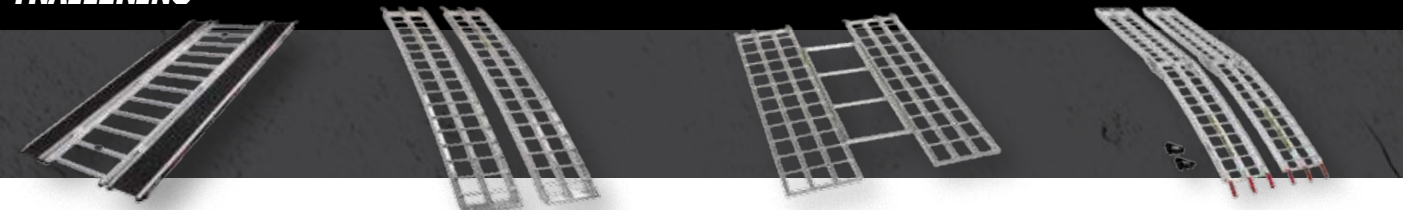

RAMP PRO BY CALIBER®

- Designed for ATVs and UTVs up to 127 cm wide
- Integrated grip glides for ultimate traction
- Folding sides for easy transportation & storing
- » 224 cm x 30 cm • 2883005

ALUMINUM ARCHED LOADING RAMPS

- » 193 cm x 30 cm 2000 LB (907.2 KG) • 2875384
- » 193 cm x 30 cm 3,000 LB (1361 KG) • 2875386

LIGHTWEIGHT TRI-FOLD RAMPS

- Ramp folds up for transport
- Capacity for up to 1500 LB (680.7 KG)
- Safety straps included
- » 183 cm x 130 cm • 2875385
- » 208 cm x 130 cm • 2875860

FOLDING ALUMINUM ARCHED RAMPS

- Ramp folds up for transport
- Capacity for up to 1500 LB (680.7 KG)
- Safety straps included
- » 224 cm x 30 cm • 2875387

RECEIVER HITCH

- » 5 cm RECEIVER • 2875320
- » FRONT HITCH RECEIVER • 2878846



TRAILER BALL 1.9 cm SHANK

- » 5.4 cm • 2877602
- » 5 cm • 2877603



TIE-DOWN RATCHET STRAPS

- 3.8 cm shockstrap ratchet with safety strap
- » 2859047-01 • RED
- » 2859047-02 • BLACK



TRAILERABLE COVER BY POLARIS®

» 2881841 POLARIS GENERAL 4 '17-18

» 2881787 • 4-SEAT POLARIS GENERAL '16-18



SHOP CLEANERS

ALL-PURPOSE CLEANER PLUS

- Professional-grade formula removes built-up stains from shop floors, work benches, and other hard surfaces. VOC-free, environmentally-friendly, and biodegradable.

» 4 L • 2830414 » 19 L • 2830416

VEHICLE & EQUIPMENT WASH

- Concentrated professional grade formula powers through vehicle buildup, dirt, and grease with a spot-free rinse. Treat up to 121 L Biodegradable.

» 4 L • 2830417 » 19 L • 2830422

HD CLEANER & DEGREASER

- Professional-grade, biodegradable, high-foaming formula dissolves and removes tough stains and soils.

» 4 L • 2830418 » 19 L • 2830420

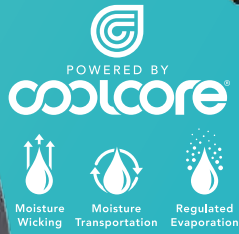

TENACITY HELMET

- Injection molded plastic
- 1450 grams
- 14 intake and 8 exhaust vents for airflow
- DOT and ECE Certified
- » 2868624 • PINK XS-2XL

COOLING SHIRTS

- 100% Poly, chemical-free patented fabric from CoolCore®
- Moisture wicking to keep you dry
- Moisture transportation to keep you cool
- UPF 45+
- » MEN'S • 2868753 GRAY/ORANGE • S-3XL
- » WOMEN'S • 2868755 GRAY/PINK • S-3XL

509° KINGPIN GOGGLE

- Quick-change lens technology
- Contoured triple layer foam
- Premium anti-fog & anti-scratch coatings
- » 2868668 • ORANGE ONE SIZE

509° ALTITUDE CARBON HELMET

- Carbon Fiber shell
- 1100 grams
- Fidlock magnet closure
- 8 intake/exhaust vents for airflow
- DOT and ECE2205 Certified
- » 2867814 • BLACK MATTE S-4XL

MEN'S SOFTSHELL JACKET

- Lined with 280 grams of fleece for warmth
- Removable hood
- Pit zips for venting
- » 2868514 • BLACK/ORANGE S-3XL

STAY WARM

509° ALTITUDE HELMET

- Thermo Poly alloy shell
- 1260 grams
- 8 intake/exhaust vents for airflow
- DOT and ECE2205 Certified
- » 2868539 • LIME S-4XL

ORV RIDING JERSEY

- 100% Poly
- Side mesh panels for venting
- » 2868711 • BLUE/LIME S-3XL

ORV RIDING GLOVES

- Lycra panels provide flexibility in grip
- Soft flex graphics on knuckles for protection
- Lightly padded palm for comfort
- Machine washable
- » 2868712 • BLUE/LIME S-3XL



FORCE HELMET

- Injection molded plastic
- 1380 grams
- 11 intake and 4 exhaust vents for airflow
- DOT Certified
- » 2868839 • BLUE XS-2XL

MID LAYERS

- Flexible pill resistant poly fleece
- Ideal for layering or on its own
- » WOMEN'S • 2868516 BLACK • S-3XL
- » MEN'S • 2868512 • BLACK • S-3XL



KEEP YOUR COOL



CAMO TRUCKER CAP

» 2868750 • CAMO • ONE SIZE

HUNTER HOODIE

» MEN'S • 2868716 • OLIVE HEATHER S-3XL
 » WOMEN'S • 2868721 [NOT SHOWN] OLIVE HEATHER • S-3XL

CAMO HOODIE

» WOMEN'S • 2867898 • CAMO S-3XL
 » MEN'S • 2867879 [NOT SHOWN] CAMO • S-3XL

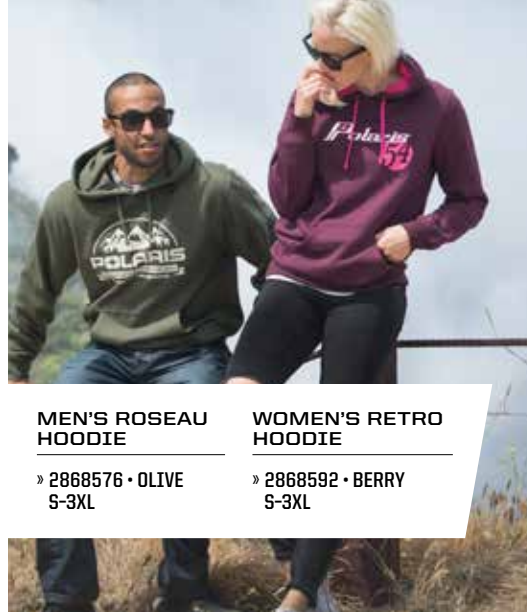

MEN'S ROSEAU HOODIE

» 2868576 • OLIVE S-3XL

WOMEN'S RETRO HOODIE

» 2868592 • BERRY S-3XL



'MERICA RETRO CAP

» 2867757 • BLUE/RED • ONE SIZE

MEN'S RETRO TEE

» 2868571 • GRAY • S-3XL

WOMEN'S RETRO CAP

» 2868617 • GRAY • ONE SIZE

WOMEN'S 3/4 BASEBALL TEE

» 2868584 • GRAY/PINK • S-3XL



MEN'S RETRO LOGO HOODIE

» 2868577 • GRAY • S-3XL



POLARIS GENERAL CAP

» 2868748 • GRAY S/M
 » 2868749 • GRAY L/XL

MEN'S POLARIS GENERAL TEE

» 2868767 • GRAY S-3XL



WOMEN'S ASYMMETRICAL HOODIE

» 2868596 • BERRY S-3XL

WOMEN'S V-NECK SCRIPT TEE

» 2868588 • GRAY S-3XL



HEX CAP

» 2867766 • BLACK • ONE SIZE

MEN'S EST TEE

» 2868570 • BLACK • S-3XL

MEN'S HEX TEE

» 2868568 • NAVY • S-3XL

WOMEN'S SCRIPT CREW SWEATSHIRT

» 2868603 • CHARCOAL • S-2XL



WOMEN'S FULL ZIP RETRO HOODIE

» 2868595 • CHARCOAL HEATHER S-3XL



REVERSIBLE CAMO BEANIE

» 2867756 • ORANGE/CAMO ONE SIZE

MEN'S CAMO TEE

» 2868757 • CAMO S-3XL

MEN'S TEXTILE RIDING JACKET

» 2867875 • COFFEE S-3XL



CAMO WATER BOTTLE

» 2867962

CAMO COFFEE TRAVEL MUG

» 2867961

CAMO BOTTLE KOOZIE

» 2867964

CAMO CAN KOOZIE

» 2867963

CAMO STEERING WHEEL COVER

» 2868663

CAMO BOTTLE OPENER [NOT SHOWN]

» 2867965



RETRO CLOCK

» 2868662

PINT GLASS SET OF 2

» 2866265

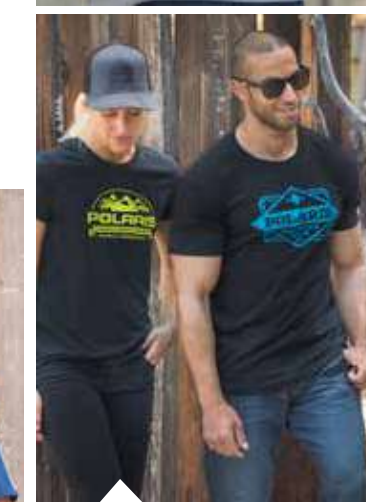

WOMEN'S ROSEAU TEE

» 2868586 • BLACK • S-3XL

MEN'S MFG CO TEE

» 2868776 • BLACK • S-3XL