

# 2010 PURE POLARIS

OFF-ROAD VEHICLE ACCESSORIES & APPAREL



# **2010 PURE POLARIS**

**OFF-ROAD VEHICLE ACCESSORIES & APPAREL**







# 2010 PURE POLARIS

OFF-ROAD VEHICLE ACCESSORIES & APPAREL

**MAKE WORK EASIER AND RIDING MORE FUN.** Right off the showroom – Polaris® Off-Road Vehicles (ORV) are the hardest working and the smoothest riding. But buying your new Polaris RANGER®, RANGER RZR® or ATV is just the beginning. Pure Polaris® accessories are designed specifically for your Polaris vehicle – they install easily, fit right and enhance functionality to make work easier and make recreational riding more fun.

In this catalog is the largest, most comprehensive collection of accessories and apparel. Customize your Polaris for the way you work, play, hunt or ride. And gear up with Pure Polaris apparel, choosing from top-quality helmets, jackets, gloves, T's, caps and more.



CAB SELECTOR **NEW**  
PG. 06 - 07

CABS **NEW**  
PG. 08 - 31

RANGER 400 **NEW**  
PG. 32 - 41

CAB COMPONENTS  
PG. 42 - 43

CAB ACCESSORIES  
PG. 44 - 45

WINCHES  
PG. 46 - 47

LIFT + CARRY  
PG. 48 - 49

PLOWS / SUSPENSION  
PG. 50 - 53

BOX ACCESSORIES  
PG. 54 - 55

STORAGE/RACKS  
PG. 56 - 58

COVERS  
PG. 58 - 59

HUNTING  
PG. 60

LIGHTING  
PG. 61

PROTECTION  
PG. 62 - 65

COMFORT / STYLE  
PG. 66 - 67

TRACKS / WHEELS  
PG. 68 - 73

FIRE + RESCUE **NEW**  
PG. 74 - 75

FIT CHARTS  
PG. 190 - 203



**MAKE WORK EASIER.** The Polaris RANGER is the hardest working, smoothest riding SxS. And with Pure Polaris accessories, it's also the best hunting, hauling, carrying, dumping, grappling and plowing SxS out there. There are cabs, plows, brushguards and winches that install easily, fit right and make work easier. Take your Polaris RANGER as far as you want.



# RANGER® CAB SELECTOR

>>>

## HOW TO SELECT THE CAB THAT IS RIGHT FOR ME.

Choosing cab components for your RANGER® is easy as 1-2-3:

1. What type of cab fits your needs and climate?
2. Which cab components fit your RANGER?
3. Which cab components do you need today?

You can purchase cab components along with your RANGER, and also add components later. It's as easy as 1-2-3.

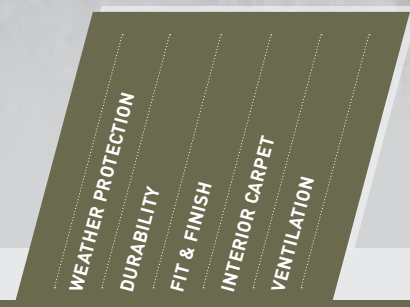

	RANGER MODELS:	KEY FEATURES:	FEATURE COMPARISONS:
<b>FIBERGLASS</b>	<input type="checkbox"/> RANGER 4x4 <input type="checkbox"/> RANGER XP <input type="checkbox"/> RANGER HD <input type="checkbox"/> RANGER 6x6 <b>NEW 2010</b> <b>RANGERWARE BY POLARIS</b> » BEST FOR: TRAIL, SPORT & HUNT	» Automotive-quality fit & finish with color options » Fully carpet-lined for sound dampening » Lockable doors » Maximum ventilation with tip-out windshield & easy-on/easy-off vented doors	W D F I V 5 4 3 2 1
<b>STEEL</b>	<input type="checkbox"/> RANGER 4x4 <input type="checkbox"/> RANGER XP <input type="checkbox"/> RANGER HD <input type="checkbox"/> RANGER 6x6 <input type="checkbox"/> RANGER CREW <input type="checkbox"/> RANGER 400, EV <b>NEW 2010</b> » BEST FOR: WORK & HEAVY-DUTY USE	» Strong, tough, durable & protective » Insulated carpet for sound dampening » Maximum ventilation with tip-out windshield & vented, easy-on/easy-off doors	W D F I V 5 4 3 2 1
<b>POLY</b>	<input type="checkbox"/> RANGER 4x4 <input type="checkbox"/> RANGER XP <input type="checkbox"/> RANGER HD » MULTI-PURPOSE USE	» Durable and lightweight » Versatile year-round comfort » Best value hard cab » Maximum ventilation with easy-on/easy-off doors	W D F I V 5 4 3 2 1
<b>CANVAS</b>	<input type="checkbox"/> RANGER 4x4 <input type="checkbox"/> RANGER XP <input type="checkbox"/> RANGER HD <input type="checkbox"/> RANGER 6x6 <input type="checkbox"/> RANGER CREW <input type="checkbox"/> RANGER 400, EV » BASIC USE	» Lightweight, easy-on/off » Ideal for warm-weather use » Outstanding value » Maximum ventilation with zip down windows & easy-on/easy-off doors	W D F I V 5 4 3 2 1

## BUILD YOUR CAB

Buy Some Now, Add Some Later

**STAGE 1 WINDSHIELD**

- » First element of every cab
- » Blocks wind, rain and debris
- » Ensures visibility
- » Easy to install

---

**STAGE 2 ROOF**

- » Overhead protection
- » Blocks sun, rain, branches
- » Fit securely to vehicle frame
- » Easily integrates with Windshield

---

**STAGE 3 REAR PANEL**

- » Reduce low pressure & dust behind Windshield
- » Blocks shifting cargo in box
- » Rear window for better visibility
- » Easily integrates with Windshield and Roof

---

**STAGE 4 DOORS**

- » Create interior environment
- » Added security & protection
- » Easy to put on and off with lift-off hinge
- » Easily integrates with Windshield, Roof and Rear Panel

---

**STAGE 5 ACCESSORIES**

- » For comfort, add a fan, heater, stereo & more

PAGE NO.
SEE THE RANGERWARE CABS ON PAGES: 08-11
SEE THE STEEL CABS ON PAGES: 12-15, 23-29 (CREW), 32-33 (400, EV)
SEE THE POLY CABS ON PAGES: 16-19
SEE THE CANVAS CABS ON PAGES: 22, 30-31 (CREW), 34-35 (400, EV)

CAB SELECTOR <b>NEW</b> PG. 06 - 07
CABS <b>NEW</b> PG. 08 - 31
RANGER 400 <b>NEW</b> PG. 32 - 41
CAB COMPONENTS PG. 42 - 43
CAB ACCESSORIES PG. 44 - 45
WINCHES PG. 46 - 47
LIFT + CARRY PG. 48 - 49
PLOWS / SUSPENSION PG. 50 - 53
BOX ACCESSORIES PG. 54 - 55
STORAGE / RACKS PG. 56 - 58
COVERS PG. 58 - 59
HUNTING PG. 60
LIGHTING PG. 61
PROTECTION PG. 62 - 65
COMFORT / STYLE PG. 66 - 67
TRACKS / WHEELS PG. 68 - 73
FIRE + RESCUE <b>NEW</b> PG. 74 - 75
FIT CHARTS PG. 190 - 203

Note: For cab component fitment on pre-model year 2010 RANGERS, refer to component descriptions in this catalog or consult your local Polaris dealer.

# RANGERWARE™ BY POLARIS

>>>

**SUPERIOR STYLE AND PROTECTION.** RANGERWARE™ By Polaris is perfect for the RANGER owner who wants both a trick custom look and rugged, modular components. This all-new system features fiberglass construction for strength and durability, and is available in color-matched components of your choice in solar red, sage green or black. This cab includes a roof and rear panel, with optional fiberglass doors that lock and windshields to build your ideal RANGERWARE cab.

**NEW  
2010**

» **BEST FOR: TRAIL, SPORT & HUNT**

» **KEY FEATURES**

» **WEATHER PROTECTION**

- Components form tight seal
- Doors seal & latch securely
- Accessories (heater, fan) add comfort

» **DURABILITY**

- Premium hand-laid fiberglass construction
- Will withstand any weather
- Tough enough for sport, trail & hunt

» **FIT & FINISH**

- Automotive-quality fit & finish
- Premium, color-matched gloss finish
- Oversized windows for maximum visibility

» **INTERIOR CARPET**

- Commercial-grade carpet insulation
- Dampens sound for rider comfort
- Cushions interior surfaces for ride

» **VENTILATION**

- Sliding glass windows in doors
- Doors remove easily when not needed
- Tip-out windshield optional

High-intensity LED lighting brightens up the interior, and has low-amp draw.

Stylish, fiberglass construction.



◀ RANGERWARE BY POLARIS CAB IS AVAILABLE IN SOLAR RED, SAGE GREEN OR BLACK

Two rear work lights for night visibility.

Featuring a glass rear window, the rear panel offers interior sound insulation and a polished fiberglass exterior finish.



Sliding-glass windows offer additional cab ventilation.

» **BUILD YOUR RANGERWARE CAB**

Buy Some Now, Add Some Later

1. Choose the components that provide the look, comfort & protection you need.
2. Add RANGERWARE Cab components that fit your budget.
3. Add cab accessories that let you control the environment inside the cab.



**STAGE 1**

**SELECT A WINDSHIELD**  
To add dust and wind protection.



**STAGE 2**

**SELECT A ROOF/REAR PANEL**  
For rain and sun protection.



**STAGE 3**

**SELECT DOORS**  
To create a full cab enclosure.

**STAGE 4**

Add cab accessories that let you control the environments.

**ORDER NOW!**

Turn the page for part numbers, fitment and component information.

CAB SELECTOR **NEW**  
PG. 06 - 07

CABS **NEW**  
PG. 08 - 31

RANGER 400 **NEW**  
PG. 32 - 41

CAB COMPONENTS  
PG. 42 - 43

CAB ACCESSORIES  
PG. 44 - 45

WINCHES  
PG. 46 - 47

LIFT + CARRY  
PG. 48 - 49

PLOWS / SUSPENSION  
PG. 50 - 53

BOX ACCESSORIES  
PG. 54 - 55

STORAGE / RACKS  
PG. 56 - 58

COVERS  
PG. 58 - 59

HUNTING  
PG. 60

LIGHTING  
PG. 61

PROTECTION  
PG. 62 - 65

COMFORT / STYLE  
PG. 66 - 67

TRACKS / WHEELS  
PG. 68 - 73

FIRE + RESCUE **NEW**  
PG. 74 - 75

FIT CHARTS  
PG. 190 - 203



# RANGERWARE COMPONENTS

>>>

**ADD IT AS YOU NEED IT.** Start creating your RANGERWARE by Polaris cab with a windshield, then add the components that provide the style, protection and comfort you need.

- » There's no deadline, no timetable. Add the Roof/Rear Panel and Doors when you need them.
- » With a complete RANGERWARE by Polaris cab, you'll have the ultimate in RANGER style and comfort.

**NEW  
2010**

Commercial grade carpeting for excellent sound dampening.

High-intensity LED lighting brightens up the interior.

Sliding-glass windows offer additional cab ventilation.



## BUILD YOUR CAB Buy Some Now, Add Some Later

### STAGE 1 WINDSHIELD



- » First element of every cab
- » Blocks wind, rain and debris
- » Ensures visibility

### STAGE 2 ROOF



- » Overhead protection
- » Blocks sun, rain, branches
- » Fits securely to vehicle frame

### REAR PANEL



- » Reduces dust behind windshield
- » Blocks shifting cargo in box
- » Window enhances visibility

### STAGE 3 DOORS



- » Create interior environment
- » Added security & protection
- » Easy to install & remove

### STAGE 4 ACCESSORIES

- » Add cab accessories that let you control the environment inside the cab.

### CUSTOM-BUILD YOUR RANGER ONLINE

VISIT [WWW.BUILDMYRANGER.COM](http://WWW.BUILDMYRANGER.COM) & use the RANGER custom configurator. Choose a model & equip it with your choice of Pure Polaris accessories. Create it, save it, print it out & bring it to your Polaris dealer to get the real thing!



RANGERWARE BY POLARIS CAB IS AVAILABLE IN SOLAR RED, SAGE GREEN OR BLACK



## ORDERING IS EASY

### STEP 1 SELECT A WINDSHIELD

#### A. RANGERWARE WINDSHIELD

PART NO. 2878014-070 | BLACK

PART NO. 2878014-342 | SOLAR RED

PART NO. 2878014-498 | SAGE GREEN

PART NO. 2878015-070 | BLACK | TIP-OUT\*

PART NO. 2878015-342 | SOLAR RED | TIP-OUT\*

PART NO. 2878015-498 | SAGE GREEN | TIP-OUT\*

FITMENT MY 09 4x4, XP, HD, MY 10 4x4, XP, HD, 6x6

\*Fall Availability

### STEP 2 SELECT A ROOF / REAR PANEL

#### B. RANGERWARE ROOF / REAR PANEL

PART NO. 2878017-070 | BLACK

PART NO. 2878017-342 | SOLAR RED

PART NO. 2878017-498 | SAGE GREEN

FITMENT MY 09 4x4, XP, HD, MY 10 4x4, XP, HD, 6x6

### STEP 3 SELECT DOORS

#### C. RANGERWARE DOORS

PART NO. 2878016-070 | BLACK\*

PART NO. 2878016-342 | SOLAR RED\*

PART NO. 2878016-498 | SAGE GREEN\*

FITMENT MY 09 4x4, XP, HD, MY 10 4x4, XP, HD, 6x6

\*Fall Availability

### ATTENTION

Adding a Windshield to any open air vehicle causes a low pressure area behind the Windshield that attracts dust to this area. To minimize this effect, Polaris recommends the use of the Pure Polaris Rear Panel any time a Windshield is installed. Polaris does not recommend combining other components for other cabs.

#### CUSTOMIZE YOUR RIDE WITH THESE ADDITIONAL ACCESSORIES SHOWN:

- EXTREME NERF BARS PG. 65
- EXTREME FRONT BRUSHGUARD PG. 63
- POLARIS 2,041 KG WINCH PG. 46
- NEW SIX RIMS W/ MAXXIS BIGHORNS PG. 70

CAB SELECTOR NEW PG. 06 - 07

CABS NEW PG. 08 - 31

RANGER 400 NEW PG. 32 - 41

CAB COMPONENTS PG. 42 - 43

CAB ACCESSORIES PG. 44 - 45

WINCHES PG. 46 - 47

LIFT + CARRY PG. 48 - 49

PLOWS / SUSPENSION PG. 50 - 53

BOX ACCESSORIES PG. 54 - 55

STORAGE / RACKS PG. 56 - 58

COVERS PG. 58 - 59

HUNTING PG. 60

LIGHTING PG. 61

PROTECTION PG. 62 - 65

COMFORT / STYLE PG. 66 - 67

TRACKS / WHEELS PG. 68 - 73

FIRE + RESCUE NEW PG. 74 - 75

FIT CHARTS PG. 190 - 203

# STEEL CAB

>>>

**INDUSTRIAL-STRENGTH PROTECTION.** For tough jobs and rough terrain, nothing beats a Polaris RANGER wrapped in steel. Our new Steel Cab is ideal for anyone who needs maximum protection working or riding off-road. It delivers excellent visibility in all directions, and features sound-dampening insulation to minimize interior noise. Windshields are made of automotive-quality safety glass. The rear panel window is polycarbonate in a rugged steel frame. Doors lift on and off without tools.

## » BEST FOR: WORK & HEAVY-DUTY USE

## » KEY FEATURES

### » WEATHER PROTECTION

- Components form tight seal
- Doors seal & latch securely
- Accessories (heater, fan) add comfort

### » DURABILITY

- Strongest, toughest cab materials
- 16-gauge steel roof & rear panel
- 14-gauge steel doors

### » FIT & FINISH

- Components install securely
- No-sag, flush-mounted latches
- Large windows for visibility

### » INTERIOR CARPET

- Commercial-grade, foam-backed insulation
- Dampens sound for rider comfort
- Cushions interior surfaces for riders

### » VENTILATION

- Doors remove easily when not needed
- Tip-out Windshield available
- Doors available with sliding windows

A top quality roof that functions with or without the windshield, rear panel or doors.

The universal windshield is constructed on a steel frame and features interior sound insulation and laminated automotive quality safety glass.

New slider windows for additional ventilation.

Durable steel cab doors offer a textured exterior finish, interior sound insulation and paddle handles and latches for a low profile that won't catch on exterior brush. Tool-less removal delivers the ultimate in convenience.

**NEW  
2010**



## » BUILD YOUR STEEL CAB Buy Some Now, Add Some Later

1. Choose the components that provide the look, comfort & protection you need.
2. Add Steel Cab components that fit your budget.
3. Add cab accessories that let you control the environment inside the cab.



**STAGE 1**

**SELECT A WINDSHIELD**  
To add dust and wind protection.



**STAGE 2**

**SELECT A ROOF**  
For rain and sun protection.



**STAGE 3**

**SELECT A REAR PANEL**  
To prevent dust swirl behind windshield.



**STAGE 4**

**SELECT DOORS**  
To create a full cab enclosure.

**STAGE 5**

Add cab accessories that let you control the environments.

**ORDER NOW!**

High quality interior sound-insulating materials line the inside of the cab system.

Slider door windows for added cab ventilation when you need more of the outdoors.

**2010 RANGER**

- CAB SELECTOR **NEW**  
PG. 06 - 07
- CABS **NEW**  
PG. 08 - 31
- RANGER 400 **NEW**  
PG. 32 - 41
- CAB COMPONENTS  
PG. 42 - 43
- CAB ACCESSORIES  
PG. 44 - 45
- WINCHES  
PG. 46 - 47
- LIFT + CARRY  
PG. 48 - 49
- PLOWS / SUSPENSION  
PG. 50 - 53
- BOX ACCESSORIES  
PG. 54 - 55
- STORAGE / RACKS  
PG. 56 - 58
- COVERS  
PG. 58 - 59
- HUNTING  
PG. 60
- LIGHTING  
PG. 61
- PROTECTION  
PG. 62 - 65
- COMFORT / STYLE  
PG. 66 - 67
- TRACKS / WHEELS  
PG. 68 - 73
- FIRE + RESCUE **NEW**  
PG. 74 - 75
- FIT CHARTS  
PG. 190 - 203



# STEEL CAB COMPONENTS

>>>

**ADD IT AS YOU NEED IT.** Start creating your Steel Cab with a windshield, then add the components that provide the style, protection and comfort you need.

- » There's no deadline, no timetable. Add the Roof/Rear Panel and Doors when you need them.
- » With a complete Steel Cab, you'll have the ultimate in RANGER protection.

**NEW  
2010**

A top quality Roof that functions with or without the Windshield, Rear Panel or Doors.

Durable Steel Cab Doors offer a textured exterior finish, interior sound insulation and paddle handles and latches for a low profile that won't catch on exterior brush.

Tool-less removal delivers the ultimate in convenience.



This tip-out automotive glass Windshield can be operated in three different positions including closed, vented and fully extended.

## BUILD YOUR CAB Buy Some Now, Add Some Later

### STAGE 1 WINDSHIELD



- » First element of every cab
- » Blocks wind, rain and debris
- » Ensures visibility

### STAGE 2 ROOF



- » Overhead protection
- » Blocks sun, rain, branches
- » Fits securely to vehicle frame

### STAGE 3 REAR PANEL



- » Reduces dust behind windshield
- » Blocks shifting cargo in box
- » Window enhances visibility

### STAGE 4 DOORS



- » Create interior environment
- » Added security & protection
- » Easy to install & remove

### STAGE 5 ACCESSORIES

- » Add cab accessories that let you control the environment inside the cab.

### CUSTOM-BUILD YOUR RANGER ONLINE

VISIT [WWW.BUILDMYRANGER.COM](http://WWW.BUILDMYRANGER.COM) & use the RANGER custom configurator. Choose a model & equip it with your choice of Pure Polaris accessories. Create it, save it, print it out & bring it to your Polaris dealer to get the real thing!

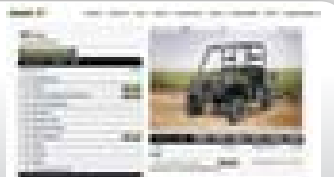

## ORDERING IS EASY

### STEP 1 SELECT A WINDSHIELD

#### A. STEEL FIXED GLASS WINDSHIELD

PART NO. 2876954-067

FITMENT MY 09-10 4x4, XP, HD

#### STEEL TIP-OUT GLASS WINDSHIELD

PART NO. 2877948-067

FITMENT MY 09-10 4x4, XP, HD, 6x6

### STEP 2 SELECT A ROOF

#### B. STEEL ROOF

PART NO. 2876951-067

FITMENT MY 09 4x4, XP, HD

PART NO. 2877827

FITMENT MY 10 4x4, XP, HD, 6x6

### STEP 3 SELECT A REAR PANEL

#### C. STEEL REAR PANEL

PART NO. 2876952-067

FITMENT MY 09 4x4, XP, HD (Required for doors)

PART NO. 2877828

FITMENT MY 10 4x4, XP, HD, 6x6 (Required for doors)

### STEP 4 SELECT DOORS

#### D. STEEL DOOR KIT

PART NO. 2876953-067

FITMENT MY 09 4x4, XP, HD

PART NO. 2877949

FITMENT MY 10 4x4, XP, HD, 6x6, MY 10 6x6

#### STEEL DOOR KIT W/SLIDER WINDOW

PART NO. 2877830-067

FITMENT MY 09-10 4x4, XP, HD

#### STEEL FIXED WIPER KIT (NOT SHOWN)

PART NO. 2876969

FITMENT Windshield 2877948-067

#### STEEL TIP-OUT WIPER KIT (NOT SHOWN)

PART NO. 2877489

FITMENT Windshield 2876955-067

### ATTENTION

Adding a Windshield to any open air vehicle causes a low pressure area behind the Windshield that attracts dust to this area. To minimize this effect, Polaris recommends the use of the Pure Polaris Rear Panel any time a Windshield is installed. Polaris does not recommend combining other components for other cabs.

### CUSTOMIZE YOUR RIDE WITH THESE ADDITIONAL ACCESSORIES SHOWN:

- NERF BARS PG. 65
- PRE-RUNNER REAR BRUSHGUARD PG. 62
- PRE-RUNNER FRONT BRUSHGUARD PG. 62
- PIAA LIGHTS PG. 61

CAB SELECTOR NEW  
PG. 06 - 07

CABS NEW  
PG. 08 - 31

RANGER 400 NEW  
PG. 32 - 41

CAB COMPONENTS  
PG. 42 - 43

CAB ACCESSORIES  
PG. 44 - 45

WINCHES  
PG. 46 - 47

LIFT + CARRY  
PG. 48 - 49

PLOWS / SUSPENSION  
PG. 50 - 53

BOX ACCESSORIES  
PG. 54 - 55

STORAGE / RACKS  
PG. 56 - 58

COVERS  
PG. 58 - 59

HUNTING  
PG. 60

LIGHTING  
PG. 61

PROTECTION  
PG. 62 - 65

COMFORT / STYLE  
PG. 66 - 67

TRACKS / WHEELS  
PG. 68 - 73

FIRE + RESCUE NEW  
PG. 74 - 75

FIT CHARTS  
PG. 190 - 203

# POLY CAB

>>>

**QUALITY PROTECTION. AFFORDABLE PRICE.** The RANGER Poly Cab is ideal for anyone who wants rugged, long-lasting, solid protection and excellent visibility. It's made of tough polyethylene, with a sealed perimeter and a textured finish that perfectly matches the stock RANGER. Choose from three windshields in your choice of glass or poly.

## » MULTI-PURPOSE USE

## » KEY FEATURES

### » WEATHER PROTECTION

- Components provide full coverage, year round
- Doors close & latch securely
- Accessories (heater, fan) add comfort

### » DURABILITY

- Strong, light-weight polyethylene construction
- Withstands rigorous off-road action
- Delivers all-season protection

### » FIT & FINISH

- Clean, finished styling with textured surface
- Low-profile roof design
- Full windows for visibility

### » VENTILATION

- Doors lift off easily without tools
- Outstanding airflow with doors removed



A stylish low-profile, no-fuss cab roof is comprised of textured polyethylene finish and features a sealed perimeter.



Tool-less removable Doors delivers the ultimate in convenience.



Shown here with easy-on, easy-off doors removed for maximum ventilation.

## » BUILD YOUR POLY CAB

Buy Some Now, Add Some Later

1. Choose the components that provide the look, comfort & protection you need.
2. Add Poly Cab components that fit your budget.
3. Add cab accessories that let you control the environment inside the cab.



**STAGE 1**  
**SELECT A WINDSHIELD**  
 To add dust and wind protection.



**STAGE 2**  
**SELECT A ROOF**  
 For rain and sun protection.



**STAGE 3**  
**SELECT A REAR PANEL**  
 To prevent dust swirl behind windshield.



**STAGE 4**  
**SELECT DOORS**  
 To create a full cab enclosure.

**STAGE 5**  
 Add cab accessories that let you control the environments.

**ORDER NOW!**

CAB SELECTOR **NEW**  
 PG. 06 - 07

CABS **NEW**  
 PG. 08 - 31

RANGER 400 **NEW**  
 PG. 32 - 41

CAB COMPONENTS  
 PG. 42 - 43

CAB ACCESSORIES  
 PG. 44 - 45

WINCHES  
 PG. 46 - 47

LIFT + CARRY  
 PG. 48 - 49

PLOWS / SUSPENSION  
 PG. 50 - 53

BOX ACCESSORIES  
 PG. 54 - 55

STORAGE / RACKS  
 PG. 56 - 58

COVERS  
 PG. 58 - 59

HUNTING  
 PG. 60

LIGHTING  
 PG. 61

PROTECTION  
 PG. 62 - 65

COMFORT / STYLE  
 PG. 66 - 67

TRACKS / WHEELS  
 PG. 68 - 73

FIRE + RESCUE **NEW**  
 PG. 74 - 75

FIT CHARTS  
 PG. 190 - 203



# POLY CAB COMPONENTS

>>>

**ADD IT AS YOU NEED IT.** Start creating your RANGER Poly Cab with a windshield, then add the components that provide the style, protection and comfort you need.

- » There's no deadline, no timetable. Add the Roof/Rear Panel and Doors when you need them.
- » With a complete Poly Cab, you'll have the ultimate in RANGER protection.

A stylish low-profile, no-fuss cab Roof is comprised of textured polyethylene finish and features a sealed perimeter.

Textured polyethylene finish, this modular Rear Panel features a sealed perimeter to create a tight, low profile appearance. It attaches to the roof and includes a fixed polycarbonate rear window.



Fixed automotive-quality laminate glass Windshield on a steel frame.

Tool-less removable Doors delivers the ultimate in convenience.

## BUILD YOUR CAB

Buy Some Now, Add Some Later

### STAGE 1 WINDSHIELD



- » First element of every cab
- » Blocks wind, rain and debris
- » Ensures visibility

### STAGE 2 ROOF



- » Overhead protection
- » Blocks sun, rain, branches
- » Fits securely to vehicle frame

### STAGE 3 REAR PANEL



- » Reduces dust behind windshield
- » Blocks shifting cargo in box
- » Window enhances visibility

### STAGE 4 DOORS



- » Create interior environment
- » Added security & protection
- » Easy to install & remove

### STAGE 5 ACCESSORIES

- » Add cab accessories that let you control the environment inside the cab.

### CUSTOM-BUILD YOUR RANGER ONLINE

VISIT [WWW.BUILDMYRANGER.COM](http://WWW.BUILDMYRANGER.COM) & use the RANGER custom configurator. Choose a model & equip it with your choice of Pure Polaris accessories. Create it, save it, print it out & bring it to your Polaris dealer to get the real thing!



## ORDERING IS EASY

### STEP 1 SELECT A WINDSHIELD

#### A. POLY GLASS WINDSHIELD

PART NO. 2877392-067

FITMENT MY 09 4x4, XP, HD, MY 10 4x4, XP, HD, 6x6

#### POLY WINDSHIELD (GENERAL PURPOSE)

PART NO. 2876958

FITMENT MY 09 4x4, XP, HD, MY 10 4x4, XP, HD, 6x6

#### POLY WINDSHIELD (HARD COAT)

PART NO. 2876959

FITMENT MY 09 4x4, XP, HD, MY 10 4x4, XP, HD, 6x6

### STEP 2 SELECT A ROOF

#### B. POLY ROOF

PART NO. 2876956-067

FITMENT MY 09 4x4, XP, HD (Includes 2877391-067)

PART NO. 2878048

FITMENT MY 10 4x4, XP, HD (Includes 2878050)

### STEP 3 SELECT A REAR PANEL

#### C. POLY REAR PANEL

PART NO. 2878049

FITMENT MY 09-10 4x4, XP, HD (Required for doors)

### STEP 4 SELECT DOORS

#### D. POLY DOOR KIT

PART NO. 2878047

FITMENT MY 10 4x4, XP, HD, MY 09 4x4, XP, HD

MY 10 4x4, XP, HD, 6x6

#### POLY ECONOMY WIPER KIT

PART NO. 2876854

FITMENT Windshield 2877392-067

### ATTENTION

Adding a Windshield to any open air vehicle causes a low pressure area behind the Windshield that attracts dust to this area. To minimize this effect, Polaris recommends the use of the Pure Polaris Rear Panel any time a Windshield is installed. Polaris does not recommend combining other components for other cabs.

#### CUSTOMIZE YOUR RIDE WITH THESE ADDITIONAL ACCESSORIES SHOWN:

- NERF BARS PG. 65
- PRE-RUNNER REAR BRUSHGUARD PG. 62
- PRE-RUNNER FRONT BRUSHGUARD PG. 62
- PIAA LIGHTS PG. 61

CAB SELECTOR NEW  
PG. 06 - 07

CABS NEW  
PG. 08 - 31

RANGER 400 NEW  
PG. 32 - 41

CAB COMPONENTS  
PG. 42 - 43

CAB ACCESSORIES  
PG. 44 - 45

WINCHES  
PG. 46 - 47

LIFT + CARRY  
PG. 48 - 49

PLOWS / SUSPENSION  
PG. 50 - 53

BOX ACCESSORIES  
PG. 54 - 55

STORAGE / RACKS  
PG. 56 - 58

COVERS  
PG. 58 - 59

HUNTING  
PG. 60

LIGHTING  
PG. 61

PROTECTION  
PG. 62 - 65

COMFORT / STYLE  
PG. 66 - 67

TRACKS / WHEELS  
PG. 68 - 73

FIRE + RESCUE NEW  
PG. 74 - 75

FIT CHARTS  
PG. 190 - 203

# BESTOP® CABS

**RUGGED, IN HARD OR SOFT TOP.** Beef up your RANGER with a cab built by Bestop® — an industry leader in truck and SUV accessories. This premium system features sliding windows on the doors and rear panel, plus soundproofing, speaker enclosures and automotive-quality fit and finish. Choose the Hard Top System for maximum protection or the Soft Top System for the versatility of enclosed or open-air use.

## » MULTI-PURPOSE USE

### BUILD YOUR CAB

Buy Some Now, Add Some Later



#### STAGE 1

**SELECT A WINDSHIELD**  
To add dust and wind protection.



#### STAGE 2

**SELECT A ROOF**  
For rain and sun protection.



#### STAGE 3

**SELECT A REAR PANEL**  
To prevent dust swirl behind windshield.



#### STAGE 4

**SELECT DOORS**  
To create a full cab enclosure.

#### STEP 5

Add cab accessories that let you control the environments.

#### ORDER NOW!

See part numbers, fitment and additional component information listed.

### BUILD YOUR CAB

Buy Some Now, Add Some Later

#### STEP 1 SELECT A WINDSHIELD

##### E. TIP-OUT GLASS WINDSHIELD

PART NO. 2876955-067  
FITMENT MY 09 4x4, XP, HD

##### FIXED GLASS WINDSHIELD

PART NO. 2876954-067  
FITMENT MY 09 4x4, XP, HD

#### STEP 2 SELECT A ROOF

##### F. SOFT CANOPY TOP

PART NO. 2876946-067  
FITMENT MY 09 4x4, XP, HD

#### STEP 3 SELECT DOORS & A-PILLAR

##### G. SOFT DOOR KIT

PART NO. 2876949-067  
FITMENT MY 09 4x4, XP, HD (Works w/ hard or soft top)

##### HARD DOOR KIT

PART NO. 2876950-067  
FITMENT MY 09 4x4, XP, HD (Works w/ hard or soft top)

##### A-PILLAR/QUARTER PANEL KIT

PART NO. 2876947-067  
FITMENT MY 09 4x4, XP, HD (Required for all Bestop® cabs)

##### SOFT TOP BOOT KIT

PART NO. 2877486  
FITMENT MY 09 4x4, XP, HD

#### ! ATTENTION

A-Pillar and quarter panel required for all Bestop® Cab systems.

#### STEP 1 SELECT A WINDSHIELD

##### A. TIP-OUT GLASS WINDSHIELD

PART NO. 2876955-067  
FITMENT MY 09 4x4, XP, HD

##### FIXED GLASS WINDSHIELD

PART NO. 2876954-067  
FITMENT MY 09 4x4, XP, HD

#### STEP 2 SELECT A ROOF

##### B. HARD CANOPY TOP

PART NO. 2876945-067  
FITMENT MY 09 4x4, XP, HD

#### STEP 3 SELECT A REAR PANEL

##### C. REAR PANEL

PART NO. 2877542-067  
FITMENT MY 09 4x4, XP, HD

#### STEP 4 SELECT DOORS & A-PILLAR

##### D. HARD DOOR KIT

PART NO. 2876950-067  
FITMENT MY 09 4x4, XP, HD (Works w/ hard or soft top)

##### A-PILLAR/QUARTER PANEL KIT

PART NO. 2876947-067  
FITMENT MY 09 4x4, XP, HD (Required for all Bestop® cabs)

##### TIP-OUT WIPER KIT

PART NO. 2877489  
FITMENT Windshield 2876955-067

##### FIXED WIPER KIT

PART NO. 2876969  
FITMENT Windshield 2876954-067

#### ! ATTENTION

Adding a Windshield to any open air vehicle causes a low pressure area behind the Windshield that attracts dust to this area. To minimize this effect, Polaris recommends the use of the Pure Polaris Rear Panel any time a Windshield is installed. Polaris does not recommend combining other components for other cabs.

✓ This versatile cab system provides state-of-the-art features including vented or fully open Windshield position.



The base of the Bestop® cab system includes replacement Quarter Panels, A-Pillar and Rear Panel. Required for all Bestop® Cab systems.

#### BESTOP® SOFT-TOP CAB (2005-08)

PART NO. 2877141  
FITMENT MY 05-08 2x4, 4x4, XP, 6x6, MY 05-09 6x6



POLARIS

2010 RANGER

CAB SELECTOR	NEW	PG. 06 - 07
CABS	NEW	PG. 08 - 31
RANGER 400	NEW	PG. 32 - 41
CAB COMPONENTS		PG. 42 - 43
CAB ACCESSORIES		PG. 44 - 45
WINCHES		PG. 46 - 47
LIFT + CARRY		PG. 48 - 49
PLOWS / SUSPENSION		PG. 50 - 53
BOX ACCESSORIES		PG. 54 - 55
STORAGE / RACKS		PG. 56 - 58
COVERS		PG. 58 - 59
HUNTING		PG. 60
LIGHTING		PG. 61
PROTECTION		PG. 62 - 65
COMFORT / STYLE		PG. 66 - 67
TRACKS / WHEELS		PG. 68 - 73
FIRE + RESCUE	NEW	PG. 74 - 75
FIT CHARTS		PG. 190 - 203



# CANVAS CABS

**ULTIMATE IN VALUE.** Our Canvas Cab is affordable and light-weight so you can put it on when the weather turns bad and take it off when the sun shines. It features durable canvas construction with a structured perimeter on the roof and rear panel. Doors and rear panel feature acrylic windows. Works with your choice of poly windshields.

## » BASIC USE

### BUILD YOUR CAB Buy Some Now, Add Some Later

#### STEP 1 SELECT A WINDSHIELD

##### A. CANVAS POLY WINDSHIELD (GENERAL PURPOSE)

PART NO. 2876958  
FITMENT MY 09-10 4x4, XP, HD, MY 10 6x6

##### CANVAS POLY WINDSHIELD (HARD COAT)

PART NO. 2876959  
FITMENT MY 09-10 4x4, XP, HD, MY 10 6x6

#### STEP 2 SELECT A ROOF / REAR PANEL

##### B. CANVAS ROOF/REAR PANEL

PART NO. 2876961-067  
FITMENT MY 09-10 4x4, XP, HD, MY 10 6x6

#### STEP 3 SELECT DOORS

##### C. CANVAS DOORS

PART NO. 2876962-067  
FITMENT MY 09-10 4x4, XP, HD, MY 10 6x6

##### D. RANGER SOFT TOP ENCLOSURE

PART NO. 2875616-070  
FITMENT Series 10-11, MY 05-08 2x4, 4x4, XP  
MY 05-09 6x6

##### E. RANGER SOFT TOP DOORS

PART NO. 2875632-070  
FITMENT Series 10-11, MY 05-08 2x4, 4x4, XP  
MY 05-09 6x6

#### ATTENTION

Adding a Windshield to any open air vehicle causes a low pressure area behind the Windshield that attracts dust to this area. To minimize this effect, Polaris recommends the use of the Pure Polaris Rear Panel any time a Windshield is installed. Polaris does not recommend combining other components for other cabs.



# STANDARD STEEL CAB

**BULLETPROOF.** With solid overall protection and rugged durability, the Standard Steel Cab is a top pick for all seasons and heavy-duty use. Features include interior sound insulation, sliding windows for added ventilation, lower windows in the door panels for added visibility and exceptional fit and finish.

### BUILD YOUR CAB Buy Some Now, Add Some Later

#### STEP 1 SELECT A WINDSHIELD

##### STEEL GLASS WINDSHIELD

PART NO. 2873436-067  
FITMENT MY 05-08 2x4, 4x4, XP, MY 05-09 6x6

##### F. STEEL TIP-OUT GLASS WINDSHIELD

PART NO. 2876272  
FITMENT MY 05-08 2x4, 4x4, XP, MY 05-09 6x6

#### STEP 2 SELECT A ROOF

##### G. STEEL ROOF

PART NO. 2873871-067  
FITMENT MY 05-08 2x4, 4x4, XP, MY 05-09 6x6

#### STEP 3 SELECT A REAR PANEL

##### H. STEEL REAR PANEL

PART NO. 2873872-067  
FITMENT MY 05-08 2x4, 4x4, XP, MY 05-09 6x6

#### STEP 4 SELECT DOORS

##### I. STEEL DOORS

PART NO. 2875871  
FITMENT MY 05-08 2x4, 4x4, XP, MY 05-09 6x6

##### STEEL WINDSHIELD VENT KIT

PART NO. 2875455  
FITMENT Windshield 2873436-067

##### STEEL WINDSHIELD WIPER KIT (PAIR)

PART NO. 2875047  
FITMENT Windshield 2873436-067

##### STEEL TIP-OUT WINDSHIELD WIPER

PART NO. 2876818  
FITMENT Windshield 2876272

A top quality roof that functions with or without the Windshield, Rear Panel or Doors.

A top quality tip-out Windshield allows for additional venting.

Slider Windows for additional ventilation.

Tool-less removable Doors delivers the ultimate in convenience.

#### ADDITIONAL WINDSHIELD FEATURES



Standard flip-up glass windshield with additional vent kit shown.



Tip-out glass windshield shown.

CAB SELECTOR NEW  
PG. 06 - 07

CABS NEW  
PG. 08 - 31

RANGER 400 NEW  
PG. 32 - 41

CAB COMPONENTS  
PG. 42 - 43

CAB ACCESSORIES  
PG. 44 - 45

WINCHES  
PG. 46 - 47

LIFT + CARRY  
PG. 48 - 49

PLOWS / SUSPENSION  
PG. 50 - 53

BOX ACCESSORIES  
PG. 54 - 55

STORAGE / RACKS  
PG. 56 - 58

COVERS  
PG. 58 - 59

HUNTING  
PG. 60

LIGHTING  
PG. 61

PROTECTION  
PG. 62 - 65

COMFORT / STYLE  
PG. 66 - 67

TRACKS / WHEELS  
PG. 68 - 73

FIRE + RESCUE NEW  
PG. 74 - 75

FIT CHARTS  
PG. 190 - 203

# CREW STEEL CAB

>>>

**INDUSTRIAL-STRENGTH PROTECTION FOR SIX.** Add protection from the elements to your 6-passenger RANGER CREW® with this heavy-duty steel cab system. It's perfect for getting a large crew out to the job site or hunt camp, year-round, in any weather. It delivers excellent visibility in all directions, and has extra sound insulation to dampen noise. Choice of two windshields, both with automotive-quality safety glass. The rear panel window is polycarbonate. Doors go on and off without tools.

» **BEST FOR: WORK & HEAVY-DUTY USE**

**NEW  
2010**

## » KEY FEATURES

### » WEATHER PROTECTION

- Components form tight seal
- Doors close & latch securely
- Accessories (heater, fan) add comfort

### » DURABILITY

- Strongest, toughest cab materials
- 16-gauge steel roof & rear panel
- 14-gauge steel doors

### » FIT & FINISH

- Components install & seal securely
- No-sag, flush-mounted latches
- Large windows for visibility

### » INTERIOR CARPET

- Dampens sound for rider comfort
- Commercial-grade, foam-backed insulation
- Carpet cushions interior surfaces for riders

### » VENTILATION

- Slider windows standard on front doors
- Tip-out Windshield kit available
- Remove Doors for excellent airflow

Standard Rear Panel features poly rear window offering maximum visibility.



New slider windows for additional ventilation.



Laminated glass Windshield designed to function closed, vented or fully open. Shown with tip-out Windshield.

Tool-less removable Doors delivers the ultimate in convenience.

## » BUILD YOUR STEEL CREW CAB

Buy Some Now, Add Some Later

1. Choose the components that provide the look, comfort & protection you need.
2. Add CREW Steel Cab components that fit your budget.
3. Add cab accessories that let you control the environment inside the cab.



STAGE 1

**SELECT A WINDSHIELD**  
To add dust and wind protection.



STAGE 2

**SELECT A ROOF**  
For rain and sun protection.



STAGE 3

**SELECT A REAR PANEL**  
To prevent dust swirl behind windshield.



STAGE 4

**SELECT DOORS**  
To create a full cab enclosure.

STAGE 5

Add cab accessories that let you control the environments.

**ORDER NOW!**



This top view demonstrates how doors open perpendicularly with new hinge systems for 2010.

**2010 RANGER**

- CAB SELECTOR **NEW**  
PG. 06 - 07
- CABS **NEW**  
PG. 08 - 31
- RANGER 400 **NEW**  
PG. 32 - 41
- CAB COMPONENTS  
PG. 42 - 43
- CAB ACCESSORIES  
PG. 44 - 45
- WINCHES  
PG. 46 - 47
- LIFT + CARRY  
PG. 48 - 49
- PLOWS / SUSPENSION  
PG. 50 - 53
- BOX ACCESSORIES  
PG. 54 - 55
- STORAGE / RACKS  
PG. 56 - 58
- COVERS  
PG. 58 - 59
- HUNTING  
PG. 60
- LIGHTING  
PG. 61
- PROTECTION  
PG. 62 - 65
- COMFORT / STYLE  
PG. 66 - 67
- TRACKS / WHEELS  
PG. 68 - 73
- FIRE + RESCUE **NEW**  
PG. 74 - 75
- FIT CHARTS  
PG. 190 - 203



# CREW STEEL CAB COMPONENTS

**ADD IT AS YOU NEED IT.** Start creating your RANGER CREW Steel Cab with a windshield, then add the components that provide the protection and comfort you need.

- » Add the Roof, Rear Panel and Doors when you need them.
- » With a complete RANGER CREW Steel Cab, you'll have the ultimate in RANGER protection and comfort.

**NEW  
2010**

## BUILD YOUR CAB Buy Some Now, Add Some Later

### STAGE 1 WINDSHIELD



- » First element of every cab
- » Blocks wind, rain and debris
- » Ensures visibility

### STAGE 2 ROOF



- » Overhead protection
- » Blocks sun, rain, branches
- » Fits securely to vehicle frame

### STAGE 3 REAR PANEL



- » Reduces dust behind windshield
- » Blocks shifting cargo in box
- » Window enhances visibility

### STAGE 4 DOORS



- » Create interior environment
- » Added security & protection
- » Easy to install & remove

### STAGE 5 ACCESSORIES

- » Add cab accessories that let you control the environment inside the cab.

Laminate glass Windshield designed to function closed, vented or fully open. Shown with tip-out Windshield.

Commercial grade carpeting for excellent sound dampening.



Tool-less removable Doors delivers the ultimate in convenience.

New slider windows for additional ventilation.

## ORDERING IS EASY

### STEP 1 SELECT A WINDSHIELD

#### A. CREW STEEL FIXED GLASS WINDSHIELD

PART NO. 2876954-067

FITMENT MY 10 CREW

#### CREW STEEL TIP-OUT GLASS WINDSHIELD

PART NO. 2877948-067

FITMENT MY 10 CREW

### STEP 2 SELECT A ROOF

#### B. CREW STEEL ROOF

PART NO. 2877903

FITMENT MY 10 CREW

### STEP 3 SELECT A REAR PANEL

#### C. CREW STEEL REAR PANEL

PART NO. 2877828

FITMENT MY 10 CREW

### STEP 4 SELECT DOORS

#### D. CREW STEEL DOOR KIT

PART NO. 2877904

FITMENT MY 10 CREW

#### CREW STEEL FIXED WIPER KIT

PART NO. 2876969

FITMENT Windshield 2876954-067

#### CREW STEEL TIP-OUT WIPER KIT

PART NO. 2877489

FITMENT Windshield 2877948-067

### ATTENTION

Adding a Windshield to any open air vehicle causes a low pressure area behind the Windshield that attracts dust to this area. To minimize this effect, Polaris recommends the use of the Pure Polaris Rear Panel any time a Windshield is installed. Polaris does not recommend combining other components for other cabs.

## CUSTOM-BUILD YOUR RANGER ONLINE

VISIT [WWW.BUILDMYRANGER.COM](http://WWW.BUILDMYRANGER.COM) & use the RANGER custom configurator. Choose a model & equip it with your choice of Pure Polaris accessories. Create it, save it, print it out & bring it to your Polaris dealer to get the real thing!

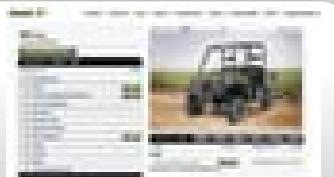

CUSTOMIZE YOUR RIDE WITH THESE ADDITIONAL PURE POLARIS ACCESSORIES SHOWN:

NERF BARS

PG. 65

36 cm BUCKSHOT RIMS

PG. 71

CAB SELECTOR **NEW**  
PG. 06 - 07

CABS **NEW**  
PG. 08 - 31

RANGER 400 **NEW**  
PG. 32 - 41

CAB COMPONENTS  
PG. 42 - 43

CAB ACCESSORIES  
PG. 44 - 45

WINCHES  
PG. 46 - 47

LIFT + CARRY  
PG. 48 - 49

PLOWS / SUSPENSION  
PG. 50 - 53

BOX ACCESSORIES  
PG. 54 - 55

STORAGE / RACKS  
PG. 56 - 58

COVERS  
PG. 58 - 59

HUNTING  
PG. 60

LIGHTING  
PG. 61

PROTECTION  
PG. 62 - 65

COMFORT / STYLE  
PG. 66 - 67

TRACKS / WHEELS  
PG. 68 - 73

FIRE + RESCUE **NEW**  
PG. 74 - 75

FIT CHARTS  
PG. 190 - 203

# CREW STEEL CAB

**PROTECT YOUR CREW.** The 2008-2009 RANGER CREW has room for six, and Pure Polaris has you all covered with this heavy-duty steel cab. It provides industrial-strength protection, with excellent visibility, sliding glass windows for ventilation and high-quality sound-insulating material to minimize interior noise while riding. The windshield has a steel frame and laminate safety glass.

## » BEST FOR: WORK & HEAVY-DUTY USE

## » KEY FEATURES

### » WEATHER PROTECTION

- Components form tight seal
- Doors close & latch securely
- Accessories (heater, fan) add comfort

### » DURABILITY

- Strongest, toughest cab materials
- 16-gauge steel roof & rear panel
- 14-gauge steel doors

### » FIT & FINISH

- Components install & seal securely
- No-sag, flush-mounted latches
- Large windows for visibility

### » VENTILATION

- Slider windows standard on front doors
- Windshield tip-out vent kit available
- Remove doors for excellent airflow



**STAGE 1**  
**SELECT A WINDSHIELD**  
 To add dust and wind protection.



**STAGE 2**  
**SELECT A ROOF**  
 For rain and sun protection.



**STAGE 3**  
**SELECT A REAR PANEL**  
 To prevent dust swirl behind windshield.



**STAGE 4**  
**SELECT DOORS**  
 To create a full cab enclosure.

**STEP 5**  
 Add cab accessories that let you control the environments.

**ORDER NOW!**  
 See part numbers, fitment and additional component information listed.



Steel-framed laminate safety glass Windshield.

Steel reinforced Rear Panel with fixed tempered glass rear window.

Doors feature interior sound insulation. Sliding window front and rear.

**CUSTOM-BUILD YOUR RANGER ONLINE**  
 VISIT [WWW.BUILDMYRANGER.COM](http://WWW.BUILDMYRANGER.COM) & use the RANGER custom configurator. Choose a model & equip it with your choice of Pure Polaris accessories. Create it, save it, print it out & bring it to your Polaris dealer to get the real thing!

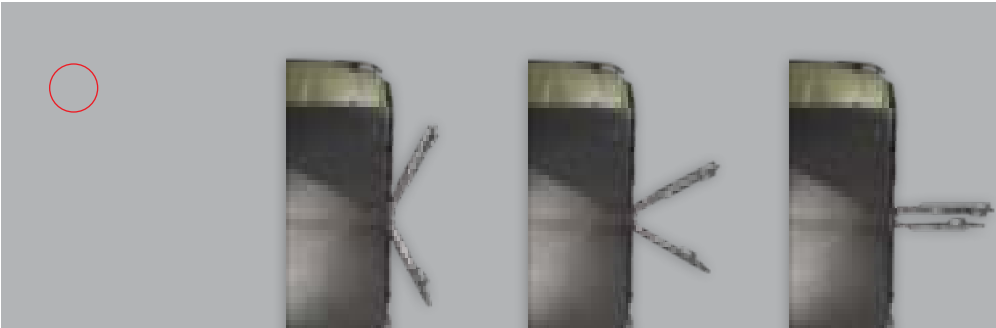

This top view demonstrates how doors open perpendicularly.

## ORDERING IS EASY

- STEP 1 SELECT A WINDSHIELD**
- A. CREW STEEL GLASS WINDSHIELD**  
 PART NO. 2873436-067  
 FITMENT MY 08-09 CREW
  - CREW STEEL/GLASS FLIP-UP WINDSHIELD**  
 PART NO. 2876272  
 FITMENT MY 08-09 CREW
- STEP 2 SELECT A ROOF**
- B. CREW STEEL CAB ROOF**  
 PART NO. 2877354-067  
 FITMENT MY 08-09 CREW
- STEP 3 SELECT A REAR PANEL**
- C. CREW STEEL CAB REAR PANEL**  
 PART NO. 2873872-067  
 FITMENT MY 08-09 CREW
- STEP 4 SELECT DOORS**
- D. CREW STEEL CAB DOOR KIT**  
 PART NO. 2877424-067  
 FITMENT MY 08-09 CREW

### ! ATTENTION

Adding a Windshield to any open air vehicle causes a low pressure area behind the Windshield that attracts dust to this area. To minimize this effect, Polaris recommends the use of the Pure Polaris Rear Panel any time a Windshield is installed. Polaris does not recommend combining other components for other cabs.

- CAB SELECTOR NEW PG. 06 - 07
- CABS NEW PG. 08 - 31
- RANGER 400 NEW PG. 32 - 41
- CAB COMPONENTS PG. 42 - 43
- CAB ACCESSORIES PG. 44 - 45
- WINCHES PG. 46 - 47
- LIFT + CARRY PG. 48 - 49
- PLOWS / SUSPENSION PG. 50 - 53
- BOX ACCESSORIES PG. 54 - 55
- STORAGE / RACKS PG. 56 - 58
- COVERS PG. 58 - 59
- HUNTING PG. 60
- LIGHTING PG. 61
- PROTECTION PG. 62 - 65
- COMFORT / STYLE PG. 66 - 67
- TRACKS / WHEELS PG. 68 - 73
- FIRE + RESCUE NEW PG. 74 - 75
- FIT CHARTS PG. 190 - 203



# CREW CANVAS CAB

>>>

**RUGGED CANVAS, EASY ON/OFF.** This rugged, high-quality Canvas Cab is perfect if you need occasional protection from the weather while working or hunting. It's lightweight so it's easy to put on and take off. The soft top includes a roll-up acrylic rear panel and integrated zippers that attach side-panel enclosures. It's recommended for use with the Polycarbonate Windshield.

## » BASIC USE

### BUILD YOUR CAB

Buy Some Now, Add Some Later

**NEW**  
2010

#### STEP 1 SELECT A WINDSHIELD

##### A. POLY WINDSHIELD (GENERAL PURPOSE)

PART NO. 2876958

FITMENT MY 09-10 4x4, CREW

##### POLY WINDSHIELD (HARD COAT)

PART NO. 2876959

FITMENT MY 10 CREW

#### STEP 2 SELECT A ROOF / REAR PANEL

##### B. CREW CANVAS ROOF / REAR PANEL

PART NO. 2877833-067

FITMENT MY 10 CREW

#### STEP 3 SELECT DOORS

##### C. CREW CANVAS DOOR KIT

PART NO. 2877834-067

FITMENT MY 10 CREW



##### D. CANVAS BOX COVER

PART NO. 2877832-067

FITMENT MY08-10 4x4, XP, CREW

\* Will not fit with RANGERWARE or BESTOP cabs.

#### ATTENTION

Adding a Windshield to any open air vehicle causes a low pressure area behind the Windshield that attracts dust to this area. To minimize this effect, Polaris recommends the use of the Pure Polaris Rear Panel any time a Windshield is installed. Polaris does not recommend combining other components for other cabs.



#### STEP 1

**SELECT A WINDSHIELD**  
To add dust and wind protection.

#### STAGE 2

**SELECT A ROOF/ REAR PANEL**  
For rain and sun protection.

#### STAGE 3

**SELECT DOORS**  
To create a full cab enclosure.

#### STAGE 4

Add cab accessories that let you control the environments.

#### ORDER NOW!

See part numbers, fitment and additional component information listed.



Economy poly Windshield protection from the elements while providing maximum visibility.



#### STEP 1 SELECT A WINDSHIELD

##### E. POLY WINDSHIELD

PART NO. 2876192

FITMENT MY 08-09, CREW

##### POLY WINDSHIELD (HARD COAT)

PART NO. 2876193

FITMENT MY 08-09 CREW

#### STEP 2 SELECT A ROOF / REAR PANEL

##### F. SOFT TOP ENCLOSURE

PART NO. 2876815-070

FITMENT MY 08-09 CREW

#### STEP 3 SELECT DOORS

##### G. SOFT TOP SIDE ENCLOSURE

PART NO. 2876768-070

FITMENT MY 08-09 CREW

### CUSTOM-BUILD YOUR RANGER ONLINE

VISIT [WWW.BUILDMYRANGER.COM](http://WWW.BUILDMYRANGER.COM) & use the RANGER

custom configurator. Choose a model & equip it with your choice of Pure Polaris accessories. Create it, save it, print it out & bring it to your Polaris dealer to get the real thing!



CUSTOMIZE YOUR RIDE WITH THESE ADDITIONAL PURE POLARIS ACCESSORIES SHOWN:

NERF BARS

PG. 65

36 cm BUCKSHOT RIMS

PG. 71

CAB SELECTOR NEW  
PG. 06 - 07

CABS NEW  
PG. 08 - 31

RANGER 400 NEW  
PG. 32 - 41

CAB COMPONENTS  
PG. 42 - 43

CAB ACCESSORIES  
PG. 44 - 45

WINCHES  
PG. 46 - 47

LIFT + CARRY  
PG. 48 - 49

PLOWS / SUSPENSION  
PG. 50 - 53

BOX ACCESSORIES  
PG. 54 - 55

STORAGE / RACKS  
PG. 56 - 58

COVERS  
PG. 58 - 59

HUNTING  
PG. 60

LIGHTING  
PG. 61

PROTECTION  
PG. 62 - 65

COMFORT / STYLE  
PG. 66 - 67

TRACKS / WHEELS  
PG. 68 - 73

FIRE + RESCUE NEW  
PG. 74 - 75

FIT CHARTS  
PG. 190 - 203

# RANGER 400 STEEL CAB

>>>

**TOUGH, RELIABLE PROTECTION.** RANGER 400 Steel Cabs are strong and durable, and they provide the most-reliable protection. Ride in comfort inside while this tough steel cab handles the rigors of hard work, rough weather and nasty terrain. To create your RANGER 400 Steel Cab: Choose components for the protection & comfort you need. Start with a Windshield & add components to custom-build your cab. Add accessories for climate control inside the cab.

## » BEST FOR: WORK & HEAVY-DUTY USE

## » KEY FEATURES

### » WEATHER PROTECTION

- Components form tight seal
- Doors close & latch securely
- Accessories (heater, fan) add comfort

### » DURABILITY

- Strongest, toughest cab materials
- 16-gauge steel roof & rear panel
- Automotive glass windshield

### » FIT & FINISH

- Components install & seal securely
- No-slag, flush-mounted latches
- Full windows for visibility

### » VENTILATION

- Zip-down windows available in doors
- Windshield 4" tip-up venting
- Remove doors for excellent airflow



STAGE 1

**SELECT A WINDSHIELD**  
To add dust and wind protection.



STAGE 2

**SELECT A ROOF**  
For rain and sun protection.



STAGE 3

**SELECT A REAR PANEL**  
To prevent dust swirl behind windshield.



STAGE 4

**SELECT DOORS**  
To create a full cab enclosure.

STEP 5

Add cab accessories that let you control the environments.

ORDER NOW!

See part numbers, fitment and additional component information listed.



**NEW 2010**

B

Canvas Doors are easy on and off with zipper-open windows and custom latch closures.

B

Polycarbonate rear window offers exceptional visibility.

C

D

## ORDERING IS EASY

### STEP 1 SELECT A WINDSHIELD

#### A. RANGER 400 STEEL CAB GLASS WINDSHIELD WITH VENTING

PART NO. 2877856  
FITMENT MY 10 400, EV

### STEP 2 SELECT A ROOF

#### B. RANGER 400 STEEL CAB ROOF

PART NO. 2877859  
FITMENT MY 10 400, EV

### STEP 3 SELECT A REAR PANEL

#### C. RANGER 400 STEEL CAB REAR PANEL

PART NO. 2877858  
FITMENT MY 10 400, EV

### STEP 4 SELECT DOORS

#### D. RANGER 400 STEEL CAB SOFT DOORS

PART NO. 2877857  
FITMENT MY 10 400, EV  
\*Available Fall 2009

#### WINDSHIELD WIPER KIT

PART NO. 2878025  
FITMENT MY 10 400, EV

### ATTENTION

Adding a Windshield to any open air vehicle causes a low pressure area behind the Windshield that attracts dust to this area. To minimize this effect, Polaris recommends the use of the Pure Polaris Rear Panel any time a Windshield is installed. Polaris does not recommend combining other components for other cabs.

### ATTENTION

Fully utilize venting features while charging RANGER EV.

## CUSTOM-BUILD YOUR RANGER ONLINE

VISIT [WWW.BUILDMYRANGER.COM](http://WWW.BUILDMYRANGER.COM) & use the RANGER custom configurator. Choose a model & equip it with your choice of Pure Polaris accessories. Create it, save it, print it out & bring it to your Polaris dealer to get the real thing!



Made of laminated automotive quality safety glass, the universal Windshield is constructed on a steel frame and features interior sound insulation. Windshield Venting enables the windshield to pop-out four-inches for additional ventilation.

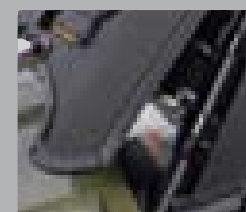

Designed to provide greater ventilation inside the cab, the Windshield vent enables the Windshield to pop out 10 cm.



Windshield wiper kit comes equipped with motor blade arms, wiring and dash-mounted spring.

PART NO. 2878025  
FITMENT MY 10 RANGER 400, EV

CAB SELECTOR NEW  
PG. 06 - 07

CABS NEW  
PG. 08 - 31

RANGER 400 NEW  
PG. 32 - 41

CAB COMPONENTS  
PG. 42 - 43

CAB ACCESSORIES  
PG. 44 - 45

WINCHES  
PG. 46 - 47

LIFT + CARRY  
PG. 48 - 49

PLOWS / SUSPENSION  
PG. 50 - 53

BOX ACCESSORIES  
PG. 54 - 55

STORAGE / RACKS  
PG. 56 - 58

COVERS  
PG. 58 - 59

HUNTING  
PG. 60

LIGHTING  
PG. 61

PROTECTION  
PG. 62 - 65

COMFORT / STYLE  
PG. 66 - 67

TRACKS / WHEELS  
PG. 68 - 73

FIRE + RESCUE NEW  
PG. 74 - 75

FIT CHARTS  
PG. 190 - 203



# RANGER 400 CANVAS CAB

**THE VALUE OF CANVAS.** When the weather turns ugly, wrap your RANGER 400 in the Pure Polaris Canvas Cab. It's ideal for RANGER 400 owners who want a protective cab that's light and easy to handle. The components are modular, so you can add just the right amount of protection. It's built for a perfect fit to handle most weather conditions, with an easy on/off design and a price that's budget friendly.

## » BASIC USE

## » KEY FEATURES

### » WEATHER PROTECTION

- Ideal for use in warm & mild climates
- Provides shade for rider comfort
- Cab can be installed quickly when needed

### » DURABILITY

- Reliable 600-denier solution-dyed polyester
- Blocks wind, rain, sun, brush & branches
- Stands up to stormy weather

### » FIT & FINISH

- Components are strong and durable
- Rear panel & roof are single easy-on/off
- Large windows for visibility

### » VENTILATION

- Doors remove easily when not needed
- Driving without doors optimizes ventilation
- Zip-out windows provide excellent airflow



#### STEP 1

**SELECT A WINDSHIELD**  
To add dust and wind protection.

#### STAGE 2

**SELECT A ROOF/ REAR PANEL**  
For rain and sun protection.

#### STAGE 3

**SELECT DOORS**  
To create a full cab enclosure.

#### STAGE 4

Add cab accessories that let you control the environments.

#### ORDER NOW!

See part numbers, fitment and additional component information listed.



Constructed of durable weather-resistant canvas, the Roof and Rear Panel Enclosure offers a structured perimeter and see-through acrylic rear window. Easy on and off attachment.

Poly Windshield provides protection from the elements while maximizing visibility.

Canvas Doors are easy on and off attachable doors with acrylic windows and magnetic closures.

## CUSTOM-BUILD YOUR RANGER ONLINE

VISIT [WWW.BUILDMYRANGER.COM](http://WWW.BUILDMYRANGER.COM) & use the RANGER custom configurator. Choose a model & equip it with your choice of Pure Polaris accessories. Create it, save it, print it out & bring it to your Polaris dealer to get the real thing!



## ORDERING IS EASY

### STEP 1 SELECT A WINDSHIELD

#### A. RANGER 400 POLY WINDSHIELD

PART NO. 2877707

FITMENT MY 10 400, EV

#### RANGER 400 POLY WINDSHIELD (HARD COAT)

PART NO. 2877708

FITMENT MY 10 400, EV

### STEP 2 SELECT A ROOF / REAR PANEL

#### B. RANGER 400 CANVAS ROOF / REAR PANEL

PART NO. 2877854-067

FITMENT MY 10 400, EV

### STEP 3 SELECT DOORS

#### C. RANGER 400 CANVAS DOORS

PART NO. 2877855-067

FITMENT MY 10 400, EV

### ! ATTENTION

Adding a Windshield to any open air vehicle causes a low pressure area behind the Windshield that attracts dust to this area. To minimize this effect, Polaris recommends the use of the Pure Polaris Rear Panel any time a Windshield is installed. Polaris does not recommend combining other components for other cabs.

### ! ATTENTION

Fully utilize venting features while charging RANGER EV.

#### CUSTOMIZE YOUR RIDE WITH THESE ADDITIONAL PURE POLARIS ACCESSORIES SHOWN:

- |                            |        |                               |        |
|----------------------------|--------|-------------------------------|--------|
| ■ STEP NERF BARS           | PG. 37 | ■ LOCK & RIDE GUN SCABBARD    | PG. 38 |
| ■ STANDARD REAR BUMPER     | PG. 37 | ■ KOPLIN® MOSSY OAK® GUN BOOT | PG. 60 |
| ■ LOCK & RIDE CARGO BOX II | PG. 38 | ■ WARN® RT 30 WINCH           | PG. 41 |

CAB SELECTOR NEW  
PG. 06 - 07

CABS NEW  
PG. 08 - 31

RANGER 400 NEW  
PG. 32 - 41

CAB COMPONENTS  
PG. 42 - 43

CAB ACCESSORIES  
PG. 44 - 45

WINCHES  
PG. 46 - 47

LIFT + CARRY  
PG. 48 - 49

PLOWS / SUSPENSION  
PG. 50 - 53

BOX ACCESSORIES  
PG. 54 - 55

STORAGE / RACKS  
PG. 56 - 58

COVERS  
PG. 58 - 59

HUNTING  
PG. 60

LIGHTING  
PG. 61

PROTECTION  
PG. 62 - 65

COMFORT / STYLE  
PG. 66 - 67

TRACKS / WHEELS  
PG. 68 - 73

FIRE + RESCUE NEW  
PG. 74 - 75

FIT CHARTS  
PG. 190 - 203

# NEW RANGER 400 ACCESSORIES

**PICK AND CHOOSE.** There are many new Polaris-exclusive accessories you can add to your RANGER 400. On this page are a variety of items you can use to give your vehicle greater protection and pulling power.

## A. BIMINI TOP

- Durable, weather-resistant canvas
- Easy attachment with quick-release buckles and Velcro® straps

PART NO. 2877852-067

FITMENT MY 10 400, EV

## B. SPORT ROOF

- Ideal for hunting and trail riding
- Made of rugged, high-density polyethylene

PART NO. 2877710

FITMENT MY 10 400, EV

## C. POLY WINDSHIELD (GENERAL PURPOSE)

PART NO. 2877707

FITMENT MY 10 400, EV

## POLY WINDSHIELD (HARD COAT)

PART NO. 2877708

FITMENT MY 10 400, EV

## D. HALF WINDSHIELD

- Provides maximum visibility, protection from wind and debris
- Polycarbonate construction, with top lip to deflect air flow

PART NO. 2877706

FITMENT MY 10 400, EV



## E. CANVAS REAR PANEL

- Durable, weather-resistant canvas
- See-through acrylic rear window

PART NO. 2877853-067

FITMENT MY 10 400, EV

## F. POLY REAR PANEL

- Easy on/off with a fixed polycarbonate window
- Recommended when using a windshield

PART NO. 2877712

FITMENT MY 10 400, EV

## I. STEP NERF BARS

- Designed for the new RANGER 400
- Rugged 5 cm diameter bars add side protection

PART NO. 2877703-458

FITMENT MY 10 400, EV



## J. FRONT BRUSHGUARD

- Protection and style for RANGER models
- Solid construction and durability
- Tall design protects hood and headlights
- Includes auxiliary light mounts (lights sold separately)

PART NO. 2877765-458

FITMENT MY 10 400, EV

## K. STANDARD REAR BUMPER

- Adds rear protection and a custom look
- Solid 5 cm diameter for off-road durability

PART NO. 2877711-458

FITMENT MY 10 400, EV



- CAB SELECTOR NEW PG. 06 - 07
- CABS NEW PG. 08 - 31
- RANGER 400 NEW PG. 32 - 41
- CAB COMPONENTS PG. 42 - 43
- CAB ACCESSORIES PG. 44 - 45
- WINCHES PG. 46 - 47
- LIFT + CARRY PG. 48 - 49
- PLOWS / SUSPENSION PG. 50 - 53
- BOX ACCESSORIES PG. 54 - 55
- STORAGE / RACKS PG. 56 - 58
- COVERS PG. 58 - 59
- HUNTING PG. 60
- LIGHTING PG. 61
- PROTECTION PG. 62 - 65
- COMFORT / STYLE PG. 66 - 67
- TRACKS / WHEELS PG. 68 - 73
- FIRE + RESCUE NEW PG. 74 - 75
- FIT CHARTS PG. 190 - 203



# NEW RANGER 400 ACCESSORIES

**ALL THE EXTRAS.** The more you use your RANGER 400 the more you'll discover the benefit of adding Pure Polaris accessories. Gun boots and a rack for hunting, a cover you can use when trailering, heater, tool rack and more. All designed to fit, to work and to last.



## A. GUN SCABBARD MOUNT

- Holds two gun scabbards (sold separately)
- Lock & Ride® technology for easy on/off

PART NO. 2877709

FITMENT MY 10 400, EV

## B. KOLPIN® GUN BOOTS

- Securely protects and holds firearm
- Works with shotgun or rifle
- Padded interior, dust-proof, water-resistant

PART NO. 2872677-419

COLOR Mossy Oak® Break-up® Gun Boot

FITMENT MY 10 400, EV

PART NO. 2872677

COLOR Black Gun Boot

FITMENT MY 10 400, EV

## C. LOCK & RIDE® CARGO BOX II

- High-capacity, highly versatile cargo box to store gear and cargo
- Box features high-volume wet/dry capacity, with security latch
- Interior Lock & Ride expanding anchors secure box to top of bedwall

PART NO. 2877033

FITMENT MY 10 400, EV

## D. TRAILERABLE COVER

- Protects your RANGER during storage and transport
- Weather-resistant canvas, with RANGER logo
- Perimeter ratcheting-strap, multiple tie-down points
- Compatible with all cabs and brushguards
- Recommended for trailering cab systems, components

PART NO. 2877860

FITMENT MY 10 400, EV



## E. SHOULDER BAG

- Adds extra, easy-access storage
- Mounts between seats with Velcro® straps
- Handle opens both side zippers at once

PART NO. 2877862

FITMENT MY 10 400, EV

## F. SPEEDKEY®

- Key system controls vehicle speed
- Black key: unrestricted, Yellow key: 40 kph
- RFID technology

PART NO. 2877851

FITMENT MY 10 400

\*Available Fall 2009

## G. HORN KIT

- Lets you alert others of vehicle presence
- Installs in console area
- Connects to battery power supply

PART NO. 2875048

FITMENT MY 10 400, EV

## H. AUXILIARY BATTERY KIT

- Lets you add a second battery for electronics
- Includes isolator to separate batteries
- Switch for charging battery separately
- Mounts under driver seat

PART NO. 2877866

FITMENT MY 10 400

## I. REVERSE WARNING KIT

- Sounds alarm when vehicle is in reverse
- Adds an extra measure of safety at work and play

PART NO. 2876228

FITMENT MY 10 400

## J. HEATER KIT

- Heater mounts easily under dash
- Provides heat or extra air movement
- 2-speed fan

PART NO. 2877850

FITMENT MY 10 400

## K. TOOL RACK

- Securely holds up to 6 long-handle tools
- Keeps rear box open for large and bulky cargo

PART NO. 2877039

FITMENT MY 10 400, EV

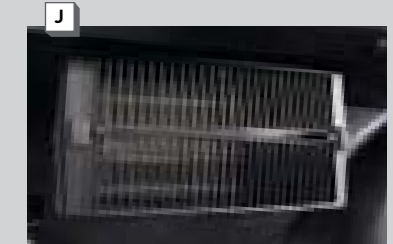
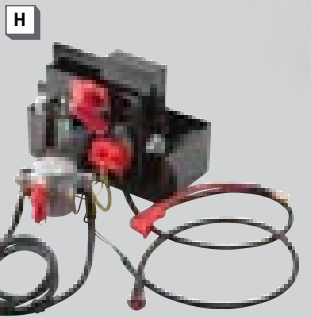

# NEW RANGER 400 PLOW

**THE ULTIMATE.** This is the absolute best plow system for your RANGER 400. First, because our engineers designed and tested every component, so you know it fits, it works and it will last. Second, because it uses our exclusive Lock & Ride® technology for the fastest on/off capability in the industry.



GLACIER II PLOW SYSTEM

### ADDITIONAL BLADE OPTION

152 cm SNOW BLADES



### ORDERING A POLARIS PLOW SYSTEM

#### STEP 1

##### SELECT A MOUNT

Our mount plates are designed exclusively for RANGER 400 models, not a "generic fit" design like our competitors.

#### STEP 2

##### SELECT A FRAME

Lock & Ride® - easy on/off

#### STEP 3

##### SELECT A LIFT METHOD

Choose a Polaris or Warn® winch.

#### STEP 4

##### SELECT A PLOW BLADE

Select a blade from our variety of sizes and capabilities. All blades fit all our plow frames.

#### STEP 1 SELECT A MOUNT

##### GLACIER® II RANGER 400 PLOW MOUNT

PART NO. 2877906  
FITMENT MY 10 400, EV

##### FRONT SPRING PRE-LOAD ADJUSTERS

- Everything you need to adjust spring pre-load
- Helps you match suspension to load

PART NO. 2876463  
FITMENT MY 10 400, EV

#### ATTENTION

Plow mount will fit with any Pure Polaris brushguard. Recommend using Coil Spring Spacers 2876463, sold in pairs.

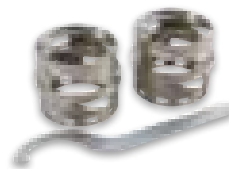

#### STEP 3 SELECT A LIFT METHOD

##### RANGER 400 POLARIS 1,587 KG. SEALED WINCH\*

PART NO. 2877864  
FITMENT MY 10 400, EV

##### RANGER 400 WARN® 3.0 RT WINCH\*

PART NO. 2877865  
FITMENT MY 10 400, EV

\*RANGER EV requires 2877940 Auxiliary Battery Kit

#### STEP 4 SELECT A PLOW BLADE

##### 152 CM RANGER SNOW BLADE

PART NO. 2876626  
FITMENT MY 10 400, EV

##### 152 CM RANGER 400 TWO-WAY BLADE

PART NO. 2875370  
FITMENT MY 10 400, EV

\*Available Fall 2009



#### G. 1,587 KG. POLARIS WINCH\*

- 15.2 m of 0.5 cm cable, with a 1,587 kg-rated pull
- Rugged 1.2 hp motor, sealed for extreme conditions
- Includes roller fairlead, hook, strap
- Integrates with all Polaris Brushguard systems

PART NO. 2877864

FITMENT MY 10 400, EV

\*RANGER EV requires 2877940 Auxiliary Battery Kit

\*Available Fall 2009



#### H. WARN® RT 30 WINCH\*

- Designed exclusively for the Polaris RANGER
- Delivers an incredible 1,360-kg rated pull
- Includes hook and red strap
- Includes external wired operating remote

PART NO. 2877865

FITMENT MY 10 400, EV

\*RANGER EV requires 2877940 Auxiliary Battery Kit





# CAB COMPONENTS

**MIX AND MATCH.** Here are more cab components you can choose from to build a RANGER cab that meets your precise off-road needs. There are full and half windshields, rear panels and roofs to add just the right amount of protection for the way you work, hunt and ride.



A

## A. BIMINI SOFT TOP

- Tight-fitting canvas soft top, with easy on/off design

PART NO. 2876963-067

FITMENT MY 09-10 4x4, XP, HD, MY 10 6x6

PART NO. 2876763-070

FITMENT MY 05-08 2x4, 4x4, XP, MY 05-10 6x6

## B. SPORT ROOF

- Adds protection from sun and rain
- Rugged yet lightweight polyethylene

PART NO. 2877946

COLOR Black

FITMENT MY 09-10 4x4, XP, HD, MY 10 6x6

PART NO. 2876399-070

COLOR Black

FITMENT MY 05-08 2x4, 4x4, XP, MY 05-10 6x6

PART NO. 2876399-195

COLOR Green

FITMENT MY 05-08 2x4, 4x4, XP, MY 05-10 6x6

## C. CREW SPORT ROOF

- Ideal for hunting and trail riding
- Made of rugged, high-density polyethylene

PART NO. 2877902-067

FITMENT MY 08-10 CREW

## D. CREW BIMINI SOFT TOP

- Made of durable, marine-grade vinyl material
- Easy attachment with quick-release buckles and Velcro® straps

PART NO. 2877909-067

FITMENT MY 10 CREW

PART NO. 2876869-070

FITMENT MY 08-09 CREW

## E. BIMINI WIND BLOCKER REAR PANEL

- Tight-fitting canvas with see-through acrylic
- Matches perfectly with Bimini Top

PART NO. 2877394-067

FITMENT MY 09-10 4x4, XP, HD, MY 10 6x6



B



C

**NEW  
2010**

D

**NEW  
2010**



E

## F. ECONOMY GLASS WINDSHIELD (FIXED)

- Fixed automotive quality laminate glass windshield on a steel frame

PART NO. 2877392-067

FITMENT MY 09-10 4x4, XP, HD, MY 10 CREW, 6x6

## G. HALF WINDSHIELD (GENERAL PURPOSE)

- Optical-grade polycarbonate
- Low-profile design

PART NO. 2876960

FITMENT MY 09-10 4x4, XP, HD, MY 10 CREW, 6x6

PART NO. 2876672

FITMENT MY 05-08, 2x4, 4x4, XP, MY 05-09 6x6, MY 08-09 CREW

## H. POLY WINDSHIELD (GENERAL PURPOSE)

- Optical-grade polycarbonate, general-purpose windshield

PART NO. 2876958

FITMENT MY 09-10 4x4, XP, HD, MY 10 CREW, 6x6

PART NO. 2876192

FITMENT MY 05-08, 2x4, 4x4, XP, MY 05-09 6x6, MY 08-09 CREW

## I. POLY WINDSHIELD (HARD COAT)

- Adds hard coat for extra abrasion resistance

PART NO. 2876959

FITMENT MY 09-10 4x4, XP, HD, MY 10 CREW, 6x6

PART NO. 2876193

FITMENT MY 05-08, 2x4, 4x4, XP, MY 05-09 6x6, MY 08-09 CREW

## J. CORNER BLOCK-OFF KIT

- Encloses top corners of cab frame
- For use with all economy windshields

PART NO. 2877391-067

FITMENT MY 09 4x4, XP, HD, 6x6 (Included with RANGER Modular Roof 2876956-067)

PART NO. 2878050

FITMENT MY 10 4x4, XP, HD, 6x6 (Included with RANGER Modular Roof 2878048)



J



F



G



H-I

## K. DASH SEAL KIT (NOT SHOWN)

- Foam panel kit seals off dash from exterior air flow

PART NO. 2877488

FITMENT MY 09-10 4x4, XP, HD, MY 10 CREW, 6x6

## L. UNDER SEAT SEAL KIT (NOT SHOWN)

- Foam kit seals gap between seat and seat base
- Reduces interior cab noise

PART NO. 2877487

FITMENT MY 09-10 4x4, XP, HD, MY 10 CREW, 6x6

- CAB SELECTOR NEW PG. 06 - 07
- CABS NEW PG. 08 - 31
- RANGER 400 NEW PG. 32 - 41
- CAB COMPONENTS PG. 42 - 43
- CAB ACCESSORIES PG. 44 - 45
- WINCHES PG. 46 - 47
- LIFT + CARRY PG. 48 - 49
- PLOWS / SUSPENSION PG. 50 - 53
- BOX ACCESSORIES PG. 54 - 55
- STORAGE / RACKS PG. 56 - 58
- COVERS PG. 58 - 59
- HUNTING PG. 60
- LIGHTING PG. 61
- PROTECTION PG. 62 - 65
- COMFORT / STYLE PG. 66 - 67
- TRACKS / WHEELS PG. 68 - 73
- FIRE + RESCUE NEW PG. 74 - 75
- FIT CHARTS PG. 190 - 203

## CAB ACCESSORIES

**ADD HEAT AND TUNES.** Ride in cool weather? Enjoy listening to music while on the trail? We know how you feel. That's why we offer a wide selection of heaters, fans, sound systems and speaker packages. Plug them in, turn them on and enjoy the ride.

### A. WINDSHIELD WASHER KIT

- Automotive-style washer system
- Includes washer fluid container and hardware

PART NO. 2877337

FITMENT MY 09-10 4x4, XP, HD, MY 10 CREW, 6x6

### B. ACCESSORY SWITCH PANEL

- Adds 3 additional switch locations to the dash
- Includes aluminum block-off plate

PART NO. 2877908

FITMENT MY 09-10 4x4, XP, HD, MY 10 CREW, 6x6

### C. HEATER KITS (2009-2010)

- Heater unit mounts easily under dash
- Provides heat or extra air movement with dash-mounted 2-speed switch
- Requires one of the adapter kits listed below

PART NO. 2876967

FITMENT MY 09-10 4x4, XP, HD, MY 10 6x6

PART NO. 2877974

FITMENT MY 09-10 CREW

### 700 - 800 EFI ADAPTOR

PART NO. 2877462

FITMENT MY 09-10 4x4, XP, HD, MY 10 CREW, 6x6

### 500 EFI ADAPTOR

PART NO. 2877463

FITMENT MY 09-10 4x4

### D. HEATER KITS (2005-2008)

- Features 2-speed fan, heat output
- Steel block-off panel optimizes efficiency
- Can use fan only to move air in warm weather

PART NO. 2875343

FITMENT MY 05-08 500 Carb, EFI Models

PART NO. 2875445C

FITMENT MY 05-08 700 EFI Models

### E. DASH DEFROST KIT

- High-speed fan with louver helps defrost windows
- Includes mounting hardware, wiring and switch
- Mounts in dash (requires cutting hole)

PART NO. 2877491

FITMENT MY 09-10 4x4, XP, HD, MY 10 CREW, 6x6

### F. DEFROST/COOLING FAN

- Helps defrost windows or cool interior
- Swivels to point air flow where needed
- Integrates with dash panel

PART NO. 2875391

FITMENT All Models



**NEW**  
2010



**NEW**  
2010



**NEW**  
2010

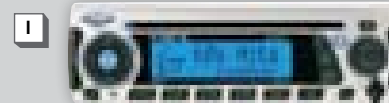
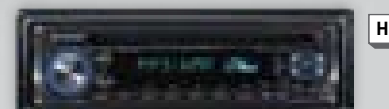
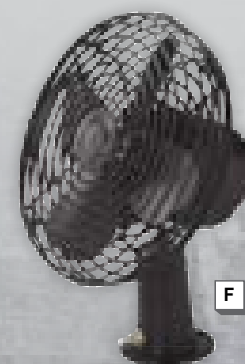
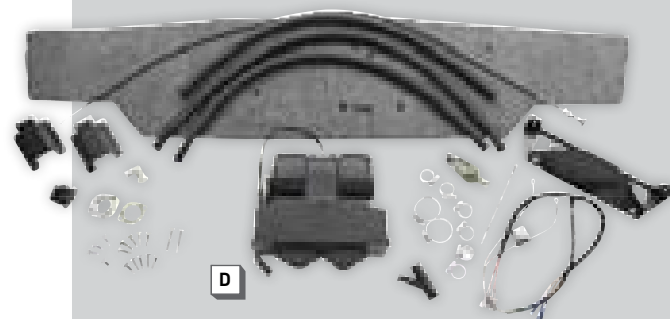

### G. UNIVERSAL STEREO INSTALLATION KIT

- Under-dash mount kit for RANGER
- Works with standard automotive stereo receivers
- Includes wiring and hardware for easy installation

PART NO. 2876970

FITMENT MY 09-10, 4x4, XP, HD, MY 10 CREW, 6x6

### H. KENWOOD® AM/FM/CD STEREO

- Compatible with iPod® and auxiliary inputs
- Detachable face
- For enclosed cabs only (not marine grade)
- Requires 2876970

PART NO. 2869510

FITMENT MY 09-10, 4x4, XP, HD, 6x6, CREW

MY 05-08 4x4, XP

### I. JENSEN® MARINE GRADE HEAD UNIT

- High-end, marine-grade CD player head unit
- Includes auxiliary input for MP3 players
- Remote control
- Requires 2876970

PART NO. 2876173-02

FITMENT MY 09-10, 4x4, XP, HD, 6x6, CREW,

MY 05-08 4x4, XP

### J. KENWOOD® MONITOR WITH DVD

- DVD/CD receiver features internal amp
- Motorized 18 cm touchscreen
- 3-band equalizer, 7 preset EQ curves
- For enclosed cabs only (not marine grade)

PART NO. 2869514

FITMENT MY 09-10, 4x4, XP, HD, 6x6, CREW

MY 05-08 4x4, XP



### K. KICK PANEL SPEAKER ENCLOSURES

- Tucks neatly out of the way under dash
- Allows use of two 15 cm diameter speakers

PART NO. 2876971

FITMENT MY 09 4x4, XP, HD, MY 10 CREW, 6x6

PART NO. 2876180

FITMENT MY 05-08 4x4, XP, CREW, 6x6, MY 09 CREW, 6x6

### L. KICKER® MARINE GRADE SPEAKER PACKAGE

- Ultimate audio performance in Polaris RANGER
- Features 1.9 cm tweeters
- All-weather marine-grade coaxial wiring

PART NO. 2876179 (Sold in pair)

FITMENT All models

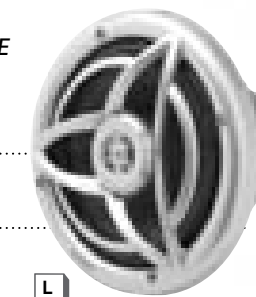

### M. SPEAKER POD ENCLOSURE KIT

- Allows speakers to be mounted above cab
- Makes your RANGER stand out loud and proud

PART NO. 2876181

FITMENT All models





# WINCHES

>>>

**HEAVY-DUTY PULLING POWER.** Your RANGER is the hardest working, smoothest riding side-by-side on the planet. Add a Pure Polaris winch and it also gives you heavy-duty pulling power for clearing trails, hauling out docks, pulling a whitetail out of a ravine, navigating difficult terrain, self-rescue and much more. Our winches are designed and tested by Polaris engineers specifically for the Polaris RANGER, so you know they'll fit perfectly and give you years of rugged pulling power.

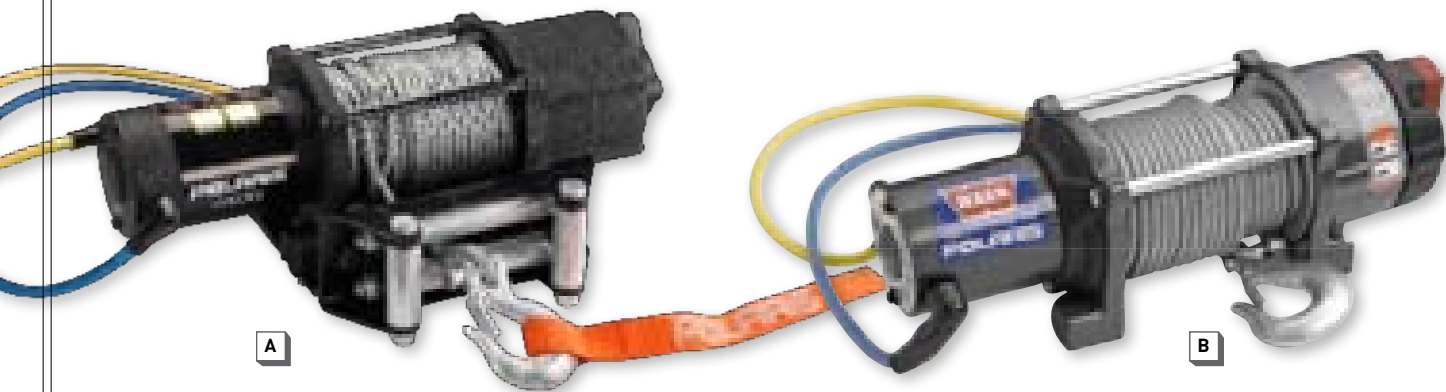

## A. POLARIS 2,042 KG. WINCH

This powerful winch is built to handle any heavy-duty task. It's a tough 1.6hp workhorse with 2,042 kg. of pulling power and is wired specifically for Polaris RANGER vehicles.

- The sealed motor and gear train allows for flawless operation in extreme conditions
- Mini-rocker corded switch
- Roller fairlead included
- Available in multi-mount, extreme and integrated

## B. WARN® RT 40 WINCH

The rugged 4.0 ci Warn Winch will pull up to 1,814 kg. It fits perfectly on RANGER vehicles – right out of the box. The winch includes a handy remote control and a durable aircraft quality cable.

- Available in:
- Multi-mount
  - Extreme
  - Integrated



## WINCHES AND PLOWS GO TOGETHER

When buying a winch, remember that it can also be used for lifting and lowering a plow blade. Be sure to install the right winch for all your pulling and plowing jobs. See pages 48-52 for plow selection.

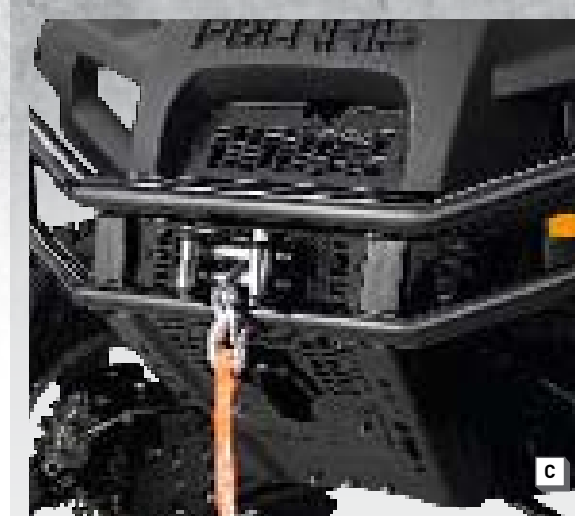

## C. INTEGRATED WINCH

Mounts behind the stock or accessory bumpers, includes mounting hardware & wiring.

### POLARIS INTEGRATED 4500 LB. WINCH

PART NO. 2877042

FITMENT MY 09-10 4x4, XP, HD, MY 10 CREW, 6x6

### 2005-08 INTEGRATED 4500 LB. WINCH

PART NO. 2877400

FITMENT MY05-08 2x4, 4x4, XP, MY 08-09 CREW, MY 05-09 6x6

### WARN® INTEGRATED RT 40 WINCH

PART NO. 2877401

FITMENT MY 09-10 4x4, XP, HD, MY 10 CREW, 6x6

### WARN® INTEGRATED 4.0 WINCH

PART NO. 2876667

FITMENT MY 05-08 2x4, 4x4, XP, 6x6, MY 08-09 CREW, MY 05-09 6x6

## D. MULTI-MOUNT WINCH

The convenient Multi-Mount option allows for front or rear receiver mounting, the kind of versatility Pure Polaris is known for. A hand-held remote and aircraft quality cable allow for safe and secure operation. Requires Front Receiver Hitch Kit 2877040 or 2855553. (Shown below)

### POLARIS MULTI-MOUNT 4500 LB. WINCH

PART NO. 2877044

FITMENT MY 09-10 4x4, XP, HD, MY 10 CREW, 6x6 with 2877978

### POLARIS MULTI-MOUNT CREW/6X6 CABLE KIT

PART NO. 2877978

FITMENT MY 05-09 6x6, MY 08-09 CREW, MY 10 CREW, 6x6

### WARN® MULTI-MOUNT RT 40 WINCH

PART NO. 2876668

FITMENT MY 09-10 4x4, XP, HD, MY 05-08 4x4, XP, MY 10 CREW 6x6 with 2877977

### WARN® MULTI-MOUNT CREW/6X6 CABLE KIT

PART NO. 2877977

FITMENT MY 05-09 6x6, MY 08-09 CREW, MY 10 CREW, 6x6

## E. EXTREME WINCH

Allows Polaris or Warn winch to be mounted on top of Extreme Bumper [2876978-521].

### POLARIS EXTREME 4500 LB. WINCH

PART NO. 2877348

FITMENT MY 09-10 4x4, XP, HD, MY 10 CREW, 6x6

### WARN® EXTREME RT 40 WINCH

PART NO. 2877402

FITMENT MY 09-10 4x4, XP, HD, MY 10 CREW, 6x6

## F. FRONT RECEIVER HITCH

- Allows you to pull from the front of your RANGER
- Works with all bumpers

PART NO. 2877040

FITMENT MY 09-10 4x4, XP, HD, CREW, 6x6

PART NO. 2855553

FITMENT MY 05-08 2x4, 4x4, XP, MY 08-09 CREW, MY 05-09 6x6

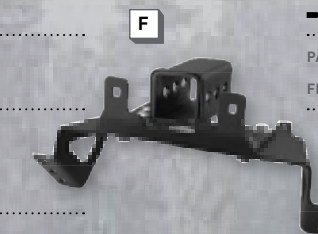

## G. POLARIS WINCH ACCESSORY KIT

- Includes tow strap, shackle and snatch block
- Carrying bag keeps it all together

PART NO. 2876105

FITMENT All Winch Applications



- CAB SELECTOR NEW PG. 06 - 07
- CABS NEW PG. 08 - 31
- RANGER 400 NEW PG. 32 - 41
- CAB COMPONENTS PG. 42 - 43
- CAB ACCESSORIES PG. 44 - 45
- WINCHES PG. 46 - 47
- LIFT + CARRY PG. 48 - 49
- PLOWS / SUSPENSION PG. 50 - 53
- BOX ACCESSORIES PG. 54 - 55
- STORAGE / RACKS PG. 56 - 58
- COVERS PG. 58 - 59
- HUNTING PG. 60
- LIGHTING PG. 61
- PROTECTION PG. 62 - 65
- COMFORT / STYLE PG. 66 - 67
- TRACKS / WHEELS PG. 68 - 73
- FIRE + RESCUE NEW PG. 74 - 75
- FIT CHARTS PG. 190 - 203

# THE BOSS® LIFT & CARRY™

**LEGENDARY WORKHORSE.** From the leading expert in snow removal equipment, and the company that builds the hardest working, smoothest riding side-by-sides, comes The BOSS® Lift & Carry System. This heavy-duty electric powered hydraulic system is able and willing to plow, bucket and grapple. With a 500-lb. lift capacity, the RANGER Boss Lift & Carry™ System reduces work time of common chores and projects. For use with RANGER HD only.



## A. THE BOSS® LIFT & CARRY LIFT SYSTEM

- SmartHitch2® Multi-Tool Interface and Vehicle Attachment System provide quick tool change-out
- SmartShield® Paint Finish to protect against corrosion
- High-performance fully enclosed hydraulics package allows the rider to perform all functions from within the cab

PART NO. 2877047

FITMENT MY 09-10 RANGER HD

*\*Does not work with accessory brushguards or bumpers*

## B. THE BOSS® LIFT & CARRY V-PLOW

- We teamed up with The BOSS to build the ultimate Lift & Carry V-Plow
- Multi-position blade flares for drift-busting power
- Width fully adjustable

PART NO. 2877048

FITMENT MY 09-10 RANGER HD (Requires 2877047 - Lift System)

*\*Does not work with accessory brushguards or bumpers*

Full Mold-Board Trip Mechanism keeps plow from getting caught on hidden obstacles.

Hydraulic Lift & Angling allows rider to position plow from inside the cab.

Multi-Position Plow Blade flares from 63.5cm at center to 77.5 cm on each end, providing serious carrying capacity and drift-busting power.

SmartShield® Paint Finish on all metal parts adds corrosion protection.

High-strength, 12.7 cm tall and 0.6 cm thick cutting edge adds wear resistance.

Width adjustable to 3 positions: Straight 2 m, VEE 1.75 m, Scoop 1.7 m to fit through narrow spots.



## C. THE BOSS® LIFT & CARRY DUMP BUCKET

- Carries and dumps fill dirt, landscaping rocks, wood, mulch and debris
- 227 kg lift capacity allows you to move some serious earth
- Corrosion resistant finish keeps it looking new for years to come

PART NO. 2877050

FITMENT MY 09-10 RANGER HD (Requires 2877047 - Lift System)

*\*Does not work with accessory brushguards or bumpers*

Features our high-gloss corrosion-resistant SmartShield® Paint Finish.

An extra large 0.1 cubic m., 227 kg capacity bucket, ensures riders will be able to move all their cargo in one trip.

To ensure long life, we've constructed this bucket of high strength 4-gauge steel.



## D. THE BOSS® LIFT & CARRY BRUSH GRAPPLE

- Picks up and hauls brush, thatch, logs, fence posts, straw and hay
- Hydraulic system holds grappled material
- Carries up to 227 kg

PART NO. 2877049

FITMENT MY 09-10 RANGER HD (Requires 2877047 - Lift System)

*\*Does not work with accessory brushguards or bumpers*

Double-acting cylinder on grapple arm provides superior hydraulic grappling power.

Grapple made of 0.5 cm Grade 80 Plate high-strength steel to ensure long life.

All metal parts painted with SmartShield® Paint Finish, featuring a zinc primer and baked-on finish coat for corrosion protection and long-lasting, high-gloss shine.

- CAB SELECTOR NEW PG. 06 - 07
- CABS NEW PG. 08 - 31
- RANGER 400 NEW PG. 32 - 41
- CAB COMPONENTS PG. 42 - 43
- CAB ACCESSORIES PG. 44 - 45
- WINCHES PG. 46 - 47
- LIFT + CARRY PG. 48 - 49
- PLOWS / SUSPENSION PG. 50 - 53
- BOX ACCESSORIES PG. 54 - 55
- STORAGE / RACKS PG. 56 - 58
- COVERS PG. 58 - 59
- HUNTING PG. 60
- LIGHTING PG. 61
- PROTECTION PG. 62 - 65
- COMFORT / STYLE PG. 66 - 67
- TRACKS / WHEELS PG. 68 - 73
- FIRE + RESCUE NEW PG. 74 - 75
- FIT CHARTS PG. 190 - 203



# THE BOSS® PLOW SYSTEM

**TAKE CHARGE.** The best name in off-road vehicles and the biggest name in plows teamed up to build this incredible plow package. This rugged plow system comes complete with all the latest heavy-duty features. And it's only available on the Polaris RANGER.



# GLACIER II HD PLOW

**LOCK & RIDE AND PLOW.** Want a rugged plow that's fast and easy to hook up, and doesn't require a winch? This is it. The new Glacier® II HD Plow is a fully featured, robust design. It has a beefy frame, an electric actuator that eliminates the need for a winch, plus the exclusive Lock & Ride® system for quick, easy hookups.

## A. THE BOSS® PLOW SYSTEM

- Lift, lower and change blade angle from inside the cab
- Hydraulics come off with the plow when detached
- Super-slick poly blade allows snow to slide off

PART NO. 2877046\*

FITMENT MY 09-10 4x4, XP, HD, MY 10 CREW, 6x6

PART NO. 2876870\*

FITMENT MY 05-08 2x4, 4x4, XP, MY 08-09 CREW, MY 05-09 6x6

\* Does not work with accessory brushguards/bumpers

All metal parts are coated with a zinc primer before the finish coat is applied and baked-on to protect against rust while providing a long-lasting, high gloss shine.

A

Unlike similar metal blades, our super-slick poly blade allows snow to slide off with less friction, resulting in less stress on the vehicle's drive train. And full color saturation keeps the plow looking new longer.

## B. GLACIER® II HD PLOW SYSTEM

- 183 cm plow blade with wear bar
- Electric actuator for up/down control
- Lock & Ride® design for easy on/off
- Manual angle adjust with adjustable shoes
- Requires Glacier II HD Plow Mount

PART NO. 2877343

FITMENT MY 05-08 2x4, XP, MY05-09 6x6, MY 08-09 CREW, MY 09-10 4x4, XP, HD, CREW, 6x6

## GLACIER II HD PLOW MOUNT

PART NO. 2878010

FITMENT MY 09-10 4x4, XP, HD, MY 10 CREW, 6x6

B

Heavy-duty springs for added strength.

Electric actuator for blade level control from inside the cab.

Single-handle blade angle adjustment.

Adjustable kickstand aids in ease of installation.

## INSTALL IN SECONDS >

Using our exclusive Lock & Ride technology, the Glacier II HD Plow installs in seconds. Just drive up to it, clamp it down and you're ready to go.



## HERE'S WHY IT'S THE BOSS >

### HIGH-PERFORMANCE HYDRAULIC PACKAGE

Easily lift, lower and change blade angle from inside the cab. When plow is detached, hydraulics come off with the plow.

### SMART HITCH® 2 ATTACHMENT SYSTEM

Lets you attach and detach the plow with little or no effort.

### SMART TOUCH 2® CONTROL

Easy-to-use, designed for either right or left-hand use. Handle can be removed, providing several different mounting options.

### HEAVY-DUTY CONTROL PLUG

Large diameter connector pins provide extremely reliable electrical connection, even in extreme weather conditions.

POLARIS

2010 RANGER

CAB SELECTOR NEW  
PG. 06 - 07

CABS NEW  
PG. 08 - 31

RANGER 400 NEW  
PG. 32 - 41

CAB COMPONENTS  
PG. 42 - 43

CAB ACCESSORIES  
PG. 44 - 45

WINCHES  
PG. 46 - 47

LIFT + CARRY  
PG. 48 - 49

PLOWS / SUSPENSION  
PG. 50 - 53

BOX ACCESSORIES  
PG. 54 - 55

STORAGE / RACKS  
PG. 56 - 58

COVERS  
PG. 58 - 59

HUNTING  
PG. 60

LIGHTING  
PG. 61

PROTECTION  
PG. 62 - 65

COMFORT / STYLE  
PG. 66 - 67

TRACKS / WHEELS  
PG. 68 - 73

FIRE + RESCUE NEW  
PG. 74 - 75

FIT CHARTS  
PG. 190 - 203

# GLACIER II PLOW SYSTEM

**MOVE SNOW FAST.** The Glacier® II Plow is designed to move snow quickly and efficiently and is perfect for light to medium snow plowing applications. It features a winch shut-off that's unique to a blade this affordable. Because it uses our exclusive Lock & Ride® technology, the plow blade goes on and off in under a minute. It requires a winch, and works with all accessories and stock bumpers.

## A. GLACIER® II PLOW SYSTEM

Lock & Ride® installation is easy:

- Align your RANGER with Glacier® Plow System
- Position lever upwards to lock in place
- Attach winch hook to plow frame
- Raise the plow and get to work

Works with all Pure accessories and stock bumper. Requires a winch for proper operation.



# GLACIER® PLOW SYSTEM

**RUGGED AND AFFORDABLE.** Want to move a lot of snow for a little money? This is your plow. It features the exclusive Lock & Ride® technology, letting you put the plow blade on or off in less than a minute.

## B. GLACIER® PLOW SYSTEM

- Exclusive Lock & Ride technology for fast attach/detach
- Adjustable blade angle
- 183 cm heavy-duty, thick-gauge steel blade
- Rugged, one-piece frame

### FLOATING WEAR BAR

Expands the Glacier® Plow System for use on soft terrain such as grass, gravel or mulch. Designed to prevent excessive dig-down.

### 183 CM FLOATING WEAR BAR

PART NO. 2875864

FITMENT Glacier 183 cm plow blade [2875697]



## 1 SELECT A MOUNT

### GLACIER PLOW MOUNT

PART NO. 2875698

FITMENT MY 05-08 2x4, 4x4, XP, MY 08-09 CREW, MY 05-09 6x6

## 2 SELECT A FRAME

### GLACIER PLOW FRAME

PART NO. 2875626

FITMENT MY 05-08 2x4, 4x4, XP, MY 08-09 CREW, MY 05-09 6x6

## 3 SELECT A BLADE

### GLACIER 183 CM PLOW BLADE

PART NO. 2875697

FITMENT MY 05-08 2x4, 4x4, XP, MY 08-09 CREW, MY 05-09 6x6

## ORDERING A POLARIS PLOW SYSTEM

### STEP 1

#### SELECT A MOUNT

Our mount plates are designed exclusively for RANGER models, not a "generic fit" design like our competitors.

### STEP 2

#### SELECT A FRAME

Lock & Ride® - easy on/off

### STEP 3

#### SELECT A LIFT METHOD

Choose a Polaris winch or Polaris Warn® winch. See page 46 for winch selection.

### STEP 4

#### SELECT A PLOW BLADE

Select a blade from our variety of sizes and capabilities. All blades fit all our plow frames.

## 1 SELECT A MOUNT

### GLACIER II PLOW MOUNT

PART NO. 2877185

FITMENT MY 09-10 4x4, XP, HD, MY 10 CREW, 6x6

## 2 SELECT A FRAME

### GLACIER II PLOW FRAME

PART NO. 2877045

FITMENT MY 09-10 4x4, XP, HD, MY 10 CREW, 6x6

## 4 SELECT A BLADE

### GLACIER 72" PLOW BLADE

PART NO. 2875697

FITMENT MY 09-10 4x4, XP, HD, MY 10 CREW, 6x6

## ! ATTENTION

Glacier and Glacier II Plow Systems require a winch found on page 46-47.

## C. HD FRONT SPRING KIT

- Adds stiffness to suspension
- Features a higher spring rate than stock springs
- Beneficial when adding cabs, heavy implements

PART NO. 2876758

FITMENT MY 05-08 4x4, XP, 6x6

PART NO. 2877052

FITMENT MY 09-10 4x4, XP, HD



## D. CREW FRONT HD SPRINGS

- Adds stiffness to suspension
- Features a higher spring rate than stock springs
- Beneficial when adding cabs, heavy implements

PART NO. 2877811

FITMENT MY 08-09 CREW

## E. NIVOMAT LOAD LEVELING REAR SHOCK KIT

- Shocks automatically lift loaded box to near unloaded height
- Helps maximize suspension travel and ground clearance
- Keeps the ride smooth during heavy-duty applications

PART NO. 2877346

FITMENT MY 09 XP, 4x4, MY 10 CREW

## F. FOX® FRONT AIR RIDE SHOCKS

- Lets you customize the ride based on load
- Great for use with cabs, plows, heavy implements
- Includes manual pump to inflate shocks

PART NO. 2877060

FITMENT MY 09-10, 4x4, XP, HD, MY 10 CREW, 6x6

- CAB SELECTOR **NEW**  
PG. 06 - 07
- CABS **NEW**  
PG. 08 - 31
- RANGER 400 **NEW**  
PG. 32 - 41
- CAB COMPONENTS  
PG. 42 - 43
- CAB ACCESSORIES  
PG. 44 - 45
- WINCHES  
PG. 46 - 47
- LIFT + CARRY  
PG. 48 - 49
- PLOWS / SUSPENSION  
PG. 50 - 53
- BOX ACCESSORIES  
PG. 54 - 55
- STORAGE / RACKS  
PG. 56 - 58
- COVERS  
PG. 58 - 59
- HUNTING  
PG. 60
- LIGHTING  
PG. 61
- PROTECTION  
PG. 62 - 65
- COMFORT / STYLE  
PG. 66 - 67
- TRACKS / WHEELS  
PG. 68 - 73
- FIRE + RESCUE **NEW**  
PG. 74 - 75
- FIT CHARTS  
PG. 190 - 203



# BOX ACCESSORIES

**ULTIMATE ORGANIZATION.** Carry big and bulky cargo. Bring along some long-handle tools and a chainsaw. Once you own a RANGER and a few of our exclusive box accessories, you'll discover you can do just about anything ... anywhere.

## A. CARGO BOX LIFT

- Heavy-duty actuator raises/lowers cargo box
- All mounts are integrated into the chassis, for easy installation
- Dump dirt, sand or mulch at the flip of a switch
- Includes all hardware and a dash-mounted switch
- Box does not work with dual battery kit [2866535] for MY05-08 RANGER.

PART NO. 2875027  
 FITMENT MY 05-08 2x4, 4x4, XP, MY 09 4x4, XP, HD, CREW  
 PART NO. 2875184  
 FITMENT MY 05-09 6x6



## B. RANGER TRACK TIE DOWN SYSTEM

- Metal strips provide multiple tie-down locations
- Mounts to bed using stock bed screw locations, no drilling
- Includes 2 track tie-downs

PART NO. 2877971  
 FITMENT MY 09-10 4x4, XP, HD, MY 10 CREW, 6x6  
 PART NO. 2877972 | ADDITIONAL TIE-DOWN HOOK  
 FITMENT Fits 2877971



## C. LOCK & RIDE® CHAINSAW MOUNT

- Secures chainsaw to the outside bedwall
- Keeps chainsaw always within reach
- Maximizes bed space for other cargo
- Lock & Ride® design for easy on/off

PART NO. 2875180  
 FITMENT MY 05-08 2x4, 4x4, XP, MY 09-10 4x4, XP, HD, MY 08-10 CREW, 6x6, MY 05-09 6x6

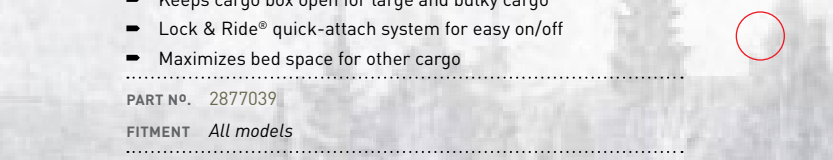

## D. LOCK & RIDE® TOOL RACK

- Securely holds up to 6 long-handle tools
- Keeps cargo box open for large and bulky cargo
- Lock & Ride® quick-attach system for easy on/off
- Maximizes bed space for other cargo

PART NO. 2877039  
 FITMENT All models

**NEW 2010**

**NEW 2010**

## E. BED WALL EXTENSIONS

- Creates higher side walls, increasing box volume
- Keeps large and bulky cargo secure while riding off-road
- Steel construction, with hinged rear door
- Lock & Ride® quick-attach system for easy on/off

PART NO. 2877905  
 FITMENT MY 09-10 4x4, XP, HD, CREW  
 MY 05-08 2x4, 4x4, XP, MY 05-10 6x6  
 MY 08-09 CREW

\* Will not fit with RANGERWARE or BESTOP cabs.



**NEW 2010**

**NEW 2010**



## F. RANGER FLAT BED

- Replaces cargo box, for carrying large cargo
- Steel construction, with built-in stake holders
- Forward divider panel, built-in tie-down points
- Utilizes stock tail lights

PART NO. 2877058  
 FITMENT MY 09-10 4x4, XP, HD, MY 10 CREW

\* Will not fit with RANGERWARE or BESTOP cabs.



## I. CANVAS BOX COVER

- Full canvas enclosure to protect your gear
- Easy up, easy down when weather turns
- Seconds to install

PART NO. 2877832-067  
 FITMENT MY 08-10 4x4, XP, CREW

\* Will not fit with RANGERWARE or BESTOP cabs.

## H. 5 CM RECEIVER HITCH

- Adds capability to pull standard trailers
- Made of strong, corrosion-resistant steel
- Includes draw pin

PART NO. 2875320  
 FITMENT All models



CAB SELECTOR **NEW**  
 PG. 06 - 07

CABS **NEW**  
 PG. 08 - 31

RANGER 400 **NEW**  
 PG. 32 - 41

CAB COMPONENTS  
 PG. 42 - 43

CAB ACCESSORIES  
 PG. 44 - 45

WINCHES  
 PG. 46 - 47

LIFT + CARRY  
 PG. 48 - 49

PLOWS / SUSPENSION  
 PG. 50 - 53

BOX ACCESSORIES  
 PG. 54 - 55

STORAGE / RACKS  
 PG. 56 - 58

COVERS  
 PG. 58 - 59

HUNTING  
 PG. 60

LIGHTING  
 PG. 61

PROTECTION  
 PG. 62 - 65

COMFORT / STYLE  
 PG. 66 - 67

TRACKS / WHEELS  
 PG. 68 - 73

FIRE + RESCUE **NEW**  
 PG. 74 - 75

FIT CHARTS  
 PG. 190 - 203

## STORAGE / RACKS

**YOU'VE GOT GEAR.** We've got the right stuff to put your stuff in — cargo boxes, a center seat console, even racks to carry a spare tire up and out of the way. Most feature our exclusive Lock & Ride technology so they go on and off in seconds.



The ultimate storage solution.

### A. LOCK & RIDE® CARGO BOX II

- High-capacity, highly versatile cargo box to store gear and cargo
- Designed so you can fit up to four boxes in the RANGER cargo box
- Each box features a 76 L wet/dry capacity, with security latch
- Interior Lock & Ride expanding anchors secure box to top of bedwall

PART NO. 2877033

FITMENT MY 09-10 4x4, XP, HD, CREW, 6x6, MY 08-09 CREW  
MY 05-09 6x6, MY 05-08 2x4, 4x4, XP



A



#### ! ATTENTION

Does not work on rear rail with Poly Cab Rear Panel, Bestop Rear Panel (2877542-067) or Box Rack (2876543-521).

### PURE POLARIS LOCK&RIDE TECHNOLOGY >

#### POLARIS LOCK & RIDE® TECHNOLOGY

Thanks to Expansion Anchor Technology from Polaris, accessories are now instant-on, instant-off with no tools, no parts to lose and no problems. Now you've got the versatility to add Gun Scabbard Mount and a Cargo Box for a long day in the woods.



B



### B. LOCK & RIDE® CARGO BOX

- Stores and protects cargo from dust, dirt and rain
- Features a large, 61 L storage capacity
- Lockable lid has full gasket for a tight seal
- RANGER bed holds two cargo boxes

PART NO. 2875056

FITMENT MY 09-10 4x4, XP, HD, CREW, 6x6, MY 08-09 CREW  
MY 05-08 2x4, 4x4, XP, MY 05-09 6x6

### C. CARGO BOX DIVIDER

- Divides the box into a front chamber and a rear chamber for carrying different materials, perfect for landscaping
- Polycarbonate with rugged steel frame
- Great for securing ballast weights for Lift & Carry
- Easy installation

PART NO. 2875057

FITMENT MY 09-10 4x4, XP, HD, CREW, 6x6, MY 08-09 CREW  
MY 05-08 2x4, 4x4, XP, MY 05-09 6x6



C



D

### D. CENTER SEAT CONSOLE

- Adds convenient storage compartment
- Features easy-access lid, multiple cup holders
- Sealed, dust-free center compartment
- Roto-mold plastic, with solid center-seat belt mounting
- Easy installation

PART NO. 2877062

FITMENT MY 09-10 4x4, XP, HD, CREW, 6x6

PURE POLARIS

2010 RANGER

CAB SELECTOR **NEW**  
PG. 06 - 07

CABS **NEW**  
PG. 08 - 31

RANGER 400 **NEW**  
PG. 32 - 41

CAB COMPONENTS  
PG. 42 - 43

CAB ACCESSORIES  
PG. 44 - 45

WINCHES  
PG. 46 - 47

LIFT + CARRY  
PG. 48 - 49

PLOWS / SUSPENSION  
PG. 50 - 53

BOX ACCESSORIES  
PG. 54 - 55

STORAGE / RACKS  
PG. 56 - 58

COVERS  
PG. 58 - 59

HUNTING  
PG. 60

LIGHTING  
PG. 61

PROTECTION  
PG. 62 - 65

COMFORT / STYLE  
PG. 66 - 67

TRACKS / WHEELS  
PG. 68 - 73

FIRE + RESCUE **NEW**  
PG. 74 - 75

FIT CHARTS  
PG. 190 - 203



# STORAGE / RACKS / COVERS

**PACK IT AND RACK IT.** We've got the right stuff to put your stuff in — cargo boxes, a center seat console, even racks to carry a spare tire up and out of the way. Most feature our exclusive Lock & Ride® technology so they go on and off in seconds.

## A. LOCK & RIDE® BOX RACK

- Versatile box rack can be used to carry spare tire and other gear
- Uses Lock & Ride® quick-attach system for easy on/off
- Accommodates Spare Tire Bar and Spare Tire Holder
- Includes 4 auxiliary-light mounting tabs (2876543-521)
- Designed for easy installation and removal

PART NO. 2876543-521

FITMENT MY 09-10 4x4, XP, HD, MY 10 CREW, 6x6

PART NO. 2876543-418

FITMENT MY 05-08 4x4, XP, MY 05-09 6x6, CREW

## B. SPARE TIRE BAR

- Spans box rack, adding strength
- Doubles as mounting surface for Spare Tire Holder
- Designed for easy installation and removal

PART NO. 2876191-418

FITMENT 2876543-418 and 2876543-521

## C. SPARE TIRE HOLDER

- Holds any spare tire with an open center
- Spans between crossbar and Spare Tire Bar
- Includes multiple mounting points
- Designed for easy installation and removal

PART NO. 2877358

FITMENT 2876543-418 and 2876543-521

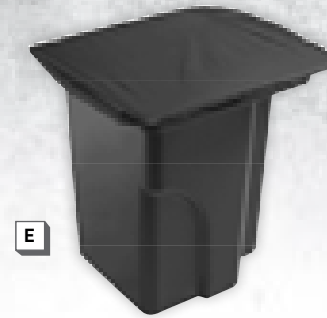

E



F



G

**NEW 2010**



H

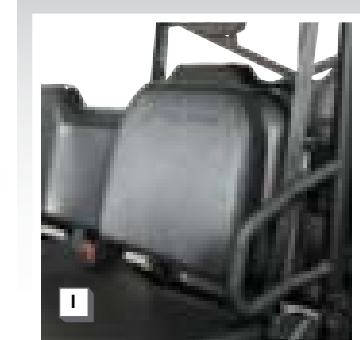

I

**NEW 2010**

## J. TRAILERABLE COVER

- Protects your RANGER during storage and transport
- Weather-resistant canvas, with RANGER logo
- Perimeter ratcheting-strap, multiple tie-down points
- Compatible with all cabs and brushguards
- Not compatible with Lock & Ride Box Rack
- Recommended for trailering cab systems, components

PART NO. 2877395-067

FITMENT MY 09-10 4x4, XP, HD, MY 05-08 4x4, XP, 2x4

## K. STORAGE COVER

- Protects your RANGER during storage and transport
- Weather-resistant canvas, with RANGER logo

PART NO. 2872386

FITMENT MY 09-10 4x4, XP, HD, MY 05-08 4x4, XP, 2x4

## L. RANGER RAMP

- Perfect for loading RANGER on trailer
- Dimensions each ramp: 224 cm x 30.5 cm unfolded
- 1,361 kg combined capacity
- Includes steel safety cables

PART NO. 2875386

FITMENT All models

## E. UNDER-SEAT STORAGE BIN COVER

- Keeps dust and debris out of storage bin
- Weather-resistant with elastic perimeter

PART NO. 2877397

FITMENT MY 09-10 4x4, XP, HD, MY 10 6x6

## F. STORAGE BIN COOLER INSERT

- Keeps food and beverages cool
- Fits inside under-seat storage compartment

PART NO. 2877398

FITMENT MY 09-10 4x4, XP, HD, MY 10 6x6

## G. LOCKABLE GLOVE BOX COVER

- Allows you to lock glove box
- Includes lock & key, cover not included

PART NO. 2877342

FITMENT MY 09-10 4x4, XP, HD, MY 10 CREW, 6x6

## H. DASH COMPARTMENT NETS

- Mesh nets help hold gear in under-dash compartments
- Set of three with hardware

PART NO. 2877396

FITMENT MY 09-10 4x4, XP, HD, MY 10 CREW, 6x6

## I. RANGER SEAT BACK PAD

- Moves driver up to better access controls
- Easy installation or removal

PART NO. 2877572

FITMENT All models



J



L

# HUNTING ACCESSORIES

**ACCESSORIES WITH FIRE POWER.** Whether you hunt big game or upland birds, predators or waterfowl, Pure Polaris has you covered with the accessories you need to carry your firearms or bow cases safe and secure over rough terrain.

## A. LOCK & RIDE® DUAL GUN SCABBARD MOUNT II

- Securely holds two gun scabbards (sold separately)
- Tubular metal crossbar for strength and durability
- Exclusive Lock & Ride® quick-attach system for easy on/off
- Mounted high to accommodate dog kennels

PART NO. 2877036

FITMENT MY 05-08 2x4, 4x4, XP, 6x6,  
MY 09-10 4x4, XP, HD, CREW MY 08-09 6x6



## B. BOW CASE MOUNT

- Designed to securely hold two bow cases (not included)
- Tubular metal crossbar for strength and durability
- Fully adjustable straps to hold different case sizes
- Adjustable to fit in cargo box of all RANGER models

PART NO. 2877038-521

FITMENT MY 05-08 2x4, 4x4, XP, 6x6,  
MY 09-10 400, 4x4, XP, HD, CREW, MY 08-09 6x6



**NEW  
2010**

## C. DUAL GUN SCABBARD MOUNT

- Attaches to top of cargo box
- Holds two gun scabbards (sold separately)
- Lock & Ride technology for easy on/off

PART NO. 2872682

FITMENT MY 05-08 2x4, 4x4, XP, 6x6,  
MY 09-10 4x4, XP, HD, CREW, 6x6 MY 08-09 6x6



## D. KOLPIN® GUN BOOT IV

- Designed to attach to Gun Scabbard Mount II
- Features padded interior, dust proof, water resistant
- Accommodates shotguns, right-hand bolt-action rifles

PART NO. 2872677 (Black)

FITMENT Mount not included, All models. 2877036, 2872682

PART NO. 2872677-419 (Mossy Oak Break-up)

FITMENT Mount not included, All models. 2877036, 2872682



**D**

**NEW  
2010**

## E. OFF-ROAD LIGHT BAR

- Nickel-plated housing, steel frame
- Blue LED ring and blue-tinted lenses
- 35 Watt halogen bulbs
- Wiring harness, rocker switch included

PART NO. 2877966

FITMENT All models



**E**

## F. HALOGEN/LED KNOCK-OUT LIGHTS

- Supplemental lighting for off-road situations
- Combination of powerful driving lights & fog lights
- One 35-watt halogen driving light per side
- Two high-output LEDs per side serve as fog lights
- LEDs have low current draw
- Weatherproof construction for reliable performance in all conditions

PART NO. 2877070

FITMENT MY 09, 4x4, XP, HD  
MY 10, 4x4, XP, HD, CREW, 6x6



**F**

**NEW  
2010**

## G. PIAA® LIGHT

- Premium-quality 35W halogen light

PART NO. 2876684

FITMENT All models



**G**

## H. BLACK RALLY LIGHT

- Premium-quality 35W 10 cm rally light

PART NO. 2877335

FITMENT All models



**H**

## I. LIGHT HARNESS

- Required for front mounting light configuration

### 2 LIGHT HARNESS

PART NO. 2877399

FITMENT All models

PART NO. 2877910

FITMENT MY 10 400

### 3 LIGHT HARNESS

PART NO. 2877336

FITMENT All models

PART NO. 2877911

FITMENT MY 10 400

## J. LOCK & RIDE LIGHT BAR

- Lock & Ride technology for easy on/off

PART NO. 2876547-458

FITMENT MY 05-08 2x4, 4x4, XP, MY 09 CREW, 6x6  
MY 09-10 4x4, XP, HD



**J**

CAB SELECTOR **NEW**  
PG. 06 - 07

CABS **NEW**  
PG. 08 - 31

RANGER 400 **NEW**  
PG. 32 - 41

CAB COMPONENTS  
PG. 42 - 43

CAB ACCESSORIES  
PG. 44 - 45

WINCHES  
PG. 46 - 47

LIFT + CARRY  
PG. 48 - 49

PLOWS / SUSPENSION  
PG. 50 - 53

BOX ACCESSORIES  
PG. 54 - 55

STORAGE / RACKS  
PG. 56 - 58

COVERS  
PG. 58 - 59

HUNTING  
PG. 60

LIGHTING  
PG. 61

PROTECTION  
PG. 62 - 65

COMFORT / STYLE  
PG. 66 - 67

TRACKS / WHEELS  
PG. 68 - 73

FIRE + RESCUE **NEW**  
PG. 74 - 75

FIT CHARTS  
PG. 190 - 203



# BRUSHGUARDS

**PROTECT YOUR INVESTMENT.** These rugged brushguards, A-arm guards, bumpers and nerf bars add an aggressive look and outstanding protection from brush, low-hanging branches, rocks and trail debris. Optimize the custom look and protection by putting both front and rear brushguards on your **RANGER**.

## A. PRE-RUNNER FRONT BRUSHGUARD

- Adds solid front-end protection and aggressive styling
- Solid 5 cm diameter tubular construction, compatible with winch
- Includes auxiliary-light mounts, heavy-duty bash plate

PART NO. 2876980-521

FITMENT MY 05-08 2x4, 4x4, XP, 6x6

MY 09-10 4x4, XP, HD, MY 10 CREW, MY 10 6x6



## B. PRE-RUNNER REAR BRUSHGUARD

- Raked design adds sporty look and rear-end protection
- Adds solid front-end protection and aggressive styling
- Solid 5 cm diameter tubular construction

PART NO. 2877339-521

FITMENT MY 09-10 4x4, XP, HD,

MY 10 CREW, MY 10 6x6



## C. FRONT A-ARM GUARDS

- Protects A-arms from damage by rocks, stumps and off-road debris
- Made of strong yet lightweight aluminum, with drain holes
- Replace stock plastic guard

PART NO. 2877029

FITMENT MY 09-10 4x4, XP, HD, MY 10 CREW, MY 10 6x6



## D. REAR A-ARM GUARDS

- Protects A-arms from damage by rocks, stumps and off-road debris
- Made of strong yet lightweight aluminum, with drain holes
- Replace stock plastic guard

PART NO. 2877030

FITMENT MY 09-10 4x4, XP, HD, MY 10 CREW, MY 10 6x6



## E. FRONT BRUSHGUARD

- Protection and style for **RANGER** models
- Solid construction and durability
- Tall design protects hood and headlights
- Includes auxiliary light mounts (lights sold separately)

PART NO. 2877822-521

FITMENT MY 09-10 4x4, XP, HD,

MY 10 CREW, MY 10 6x6

## F. EXTREME FRONT BRUSHGUARD

- The ultimate brushguard for extreme off-road use
- Plate-steel construction, with dual tow hooks
- Winch configurations, auxiliary-light mount options
- Includes heavy-duty bash plate

PART NO. 2876978-521

FITMENT MY 09-10 4x4, XP, HD, MY 10 CREW, MY 10 6x6

## G. EXTREME WINCH

- Allows Polaris or Warn® winch to be mounted on top of the Extreme bumper (2876978-521)

## POLARIS EXTREME 2,042 KG. WINCH

PART NO. 2877348

FITMENT MY09-10 4x4, XP, HD, MY 10 CREW, 6x6

## WARN® EXTREME RT 40 WINCH

PART NO. 2877402

FITMENT MY09-10 4x4, XP, HD, MY 10 CREW, 6x6

## H. STANDARD REAR BRUSHGUARD

- Adds protection and a custom look
- Durable 5 CM tubular construction
- Includes bed step for easy access

PART NO. 2877340-521

FITMENT MY09-10 4x4, XP, HD, MY10 CREW, MY10 6x6

**NEW**  
2010

E



F



G



H

CAB SELECTOR **NEW**  
PG. 06 - 07

CABS **NEW**  
PG. 08 - 31

RANGER 400 **NEW**  
PG. 32 - 41

CAB COMPONENTS  
PG. 42 - 43

CAB ACCESSORIES  
PG. 44 - 45

WINCHES  
PG. 46 - 47

LIFT + CARRY  
PG. 48 - 49

PLOWS / SUSPENSION  
PG. 50 - 53

BOX ACCESSORIES  
PG. 54 - 55

STORAGE / RACKS  
PG. 56 - 58

COVERS  
PG. 58 - 59

HUNTING  
PG. 60

LIGHTING  
PG. 61

PROTECTION  
PG. 62 - 65

COMFORT / STYLE  
PG. 66 - 67

TRACKS / WHEELS  
PG. 68 - 73

FIRE + RESCUE **NEW**  
PG. 74 - 75

FIT CHARTS  
PG. 190 - 203

## BRUSHGUARDS

**PROTECT YOUR INVESTMENT.** These rugged brushguards, A-arm guards, bumpers and nerf bars add an aggressive look and outstanding protection from brush, low-hanging branches, rocks and trail debris. Optimize the custom look and protection by putting both front and rear brushguards on your *RANGER*.

### A. FRONT BRUSHGUARDS

- Standard brushguard design in black wrinkle
- Adds front protection and a custom look

PART NO. 2874961-418

FITMENT MY 05-08 2x4, 4x4, XP, MY 08-09 CREW, MY 05-09 6x6

### B. BRUSHGUARDS EXTENSIONS

- Standard brushguard extensions in black wrinkle

PART NO. 2874467-418

FITMENT MY 05-08 2x4, 4x4, XP, MY 08-09 CREW, MY 05-09 6x6

### C. HEADLIGHT GUARDS

PART NO. 2874962-418

FITMENT MY 05-08 2x4, 4x4, XP, MY 08-09 CREW, MY 05-09 6x6

### D. EXTREME FRONT BRUSHGUARD

- Adds full front-end protection
- Aggressive styling in black wrinkle

PART NO. 2876538-418

FITMENT MY 05-08 2x4, 4x4, XP, MY 08-09 CREW, MY 05-09 6x6

### E. EXTREME FRONT SIDE GUARD

- Adds full front-end protection
- Aggressive styling in black wrinkle

PART NO. 2876539-418

FITMENT MY 05-08 2x4, 4x4, XP, MY 08-09 CREW, MY 05-09 6x6



### F. EXTREME REAR BRUSHGUARD

- Protects rear-end when backing up
- Custom styling in black wrinkle

PART NO. 2876541-418

FITMENT MY 05-08 2x4, 4x4, XP, MY 08-09 CREW



### G. REAR BUMPER 4X4

- Adds rear-end protection
- Clean, stylish design

PART NO. 2874446-418

FITMENT MY 05-08 2x4, 4x4, XP, MY 08-09 CREW

## NERF BARS

### H. NERF BARS

- Designed to match Pre-Runner Front/Rear Brushguards
- Offer a sturdy step up into your *RANGER*
- Rugged 5 cm diameter tubular construction adds side protection
- Easy installation

PART NO. 2877341-521

FITMENT MY 09-10 4x4, XP, HD

PART NO. 2874454-067 Black

PART NO. 2874454-418 Black Wrinkle

FITMENT MY 05-08 2x4, 4x4, XP

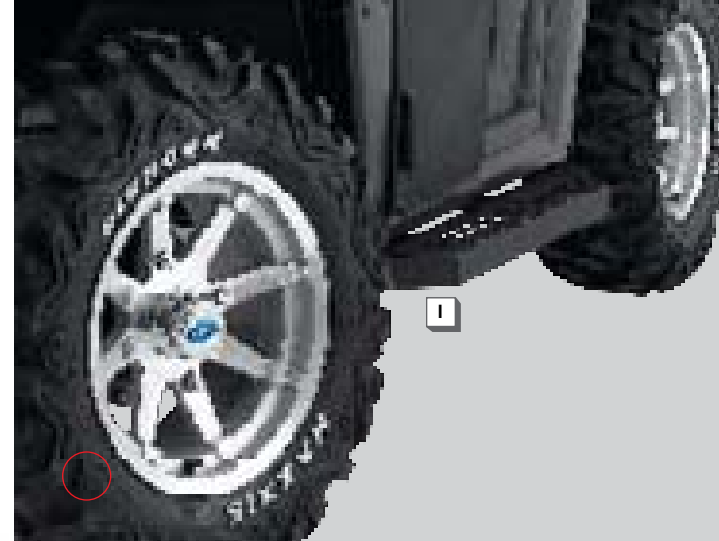

### I. EXTREME NERF BARS

- Matches Extreme Brushguard and Fender Flares
- Features a square tube design with top plate
- Offer a sturdy step up into your *RANGER*
- Heavy-duty construction and easy mounting
- Low-profile custom look

PART NO. 2876983-521

FITMENT MY 09-10 4x4, XP, HD



### J. CREW NERF BARS

- Designed specifically for the *RANGER CREW*
- Offer a sturdy step up into your *RANGER*
- Heavy-duty construction and easy mounting
- Rugged 5 cm diameter bars add side protection
- Custom styling in black wrinkle

PART NO. 2877901-521

FITMENT MY 08-10 CREW



### K. RANGER 400 NERF BARS

- Designed for the new *RANGER 400*
- Offer a sturdy step up into your *RANGER*
- Rugged 4 cm diameter bars add side protection
- Heavy-duty construction and easy mounting
- Custom styling in black wrinkle

PART NO. 2877703-458

FITMENT MY 10 400, EV



## COMFORT/STYLE

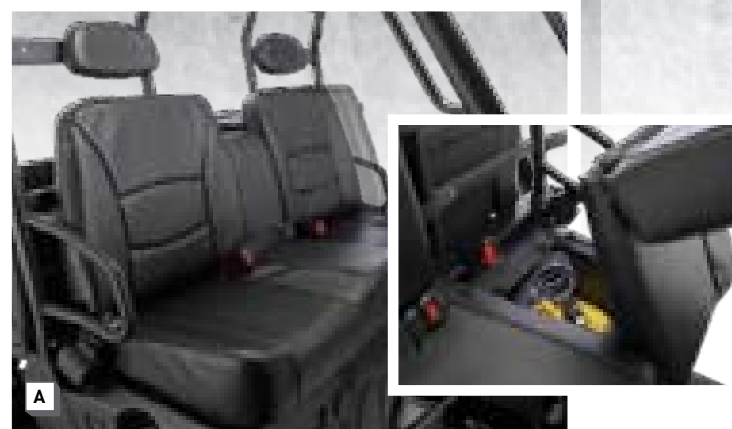

### A. FLEXSTEEL® PREMIUM SEAT KIT

- Premium, split-bench seat made by Flexsteel™, an industry leader
- Features driver's side under-seat storage compartment
- Driver's side is adjustable

PART No. 2876975-067

FITMENT MY 09-10 4x4, XP, HD

MY 10 4x4, XP, HD, 6x6, CREW



### B. FLEXSTEEL® PREMIUM SEAT KIT

- Premium bench seat made by Flexsteel®
- Features patented spring system
- Outstanding ride comfort
- Folding armrest with large cup holders
- Easy installation using factory mounts

PART No. 2876817-070

FITMENT MY 05-08 4x4, XP, MY 08-09 CREW, MY 05-09 6x6



### C. BILLET HOOD HINGES

- Same shape as stock hinges, in a billet design
- Engineered for smooth, effortless operation
- Machined to perfection
- Adds a custom touch to your RANGER

PART No. 2877072

FITMENT All models

### D. EXTENDED FENDER FLARE KIT

- Extends front and rear panels out 10 cm
- Adds splash protection and a custom look
- Does not work with Bestop® A-Pillar, Quarter Panel Kits
- Some body panel drilling required

PART No. 2877027-067

FITMENT MY09-10 4x4, XP, HD, MY10 CREW



I



J



K



L

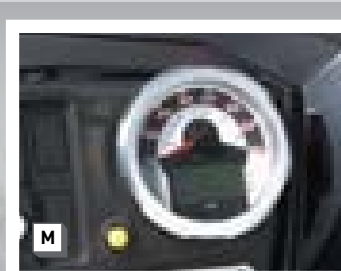

M



N

### E. DELUXE STEERING WHEEL

- Provides formed hand grips and a softer feel
- Requires Deluxe Steering Wheel Hub #2876619

PART No. 2876164

FITMENT All models

### F. DELUXE STEERING WHEEL HUB

- Required to mount the Deluxe Steering Wheel
- Machine billet construction

PART No. 2876619

FITMENT All models

### G. SPEEDKEY

- Key system controls vehicle speed
- Black key: unrestricted, Yellow key: 40 KPH
- RFID technology for carb models only

PART No. 2875179

FITMENT 500 carb only

### H. UNIVERSAL REAR VIEW MIRROR

- Enhances rear visibility and safety
- Works with cab systems, fully adjustable

PART No. 2876437

FITMENT All models

### I. DUAL BATTERY KIT

- Complete kit to wire a second battery
- Charged by main battery when main is full
- Includes isolator, wiring bar and wiring

PART No. 2877344

FITMENT MY 09-10 4x4, XP, HD

PART No. 2876535

FITMENT MY 05-08 models

### J. REVERSE WARNING KIT

- Sounds alarm when vehicle is in reverse
- Adds an extra measure of safety at work and play

PART No. 2876228

FITMENT All models

### K. HORN KIT

- Lets you alert others of vehicle presence

PART No. 2875048

FITMENT All models

### L. BILLET SHIFT KNOB

- Adds a custom touch to your RANGER

PART No. 2877074

FITMENT All models

### M. BILLET SPEEDO BEZEL

- Works on every Polaris speedo

PART No. 2877415

FITMENT All models

### N. RANGER GRAB HANDLE

- Put it anywhere you need an extra hand hold
- Easy-mount design with soft-grip handle

PART No. 2858185

FITMENT All models

# TRACKS

>>>

**GO ANYWHERE.** This is the most advanced track system ever built for Polaris RANGERS. With its many rugged, uniquely engineered features, it truly is the ultimate AWD track system for your Polaris RANGER. It holds traction better than its competition, and it's designed and engineered for an exact fit and provides the ultimate in snow performance.

**NEW  
2010**

## PROSPECTOR PRO<sup>®</sup> SR TRACK SYSTEM

The Prospector Pro is the ultimate 3-season, all-terrain AWD track system for Polaris vehicles. And this year, it's even better. We've optimized the gearing and lengthened the footprint for excellent performance in snow. Designed to provide exact fit and mounting to the RANGER. **NOT AVAILABLE UNTIL LATE FALL 2009.**

- Superior capability for farmers and ranchers, electric companies, contractors, resorts, or search and rescue
- Optimized gearing for superior low-end performance and true AWD
- Features large-diameter corner wheels to increase the approach angle and easily clear obstacles
- Spring loaded anti-rotation, incredible traction and flotation, longer wear and less maintenance
- Steering is easy
- Use in snow or low snow conditions only
- Recommend only 500lb. load with tracks



Features large-diameter corner wheels to increase the approach angle and easily clear obstacles.

Optimized gearing for superior low-end performance and true AWD.

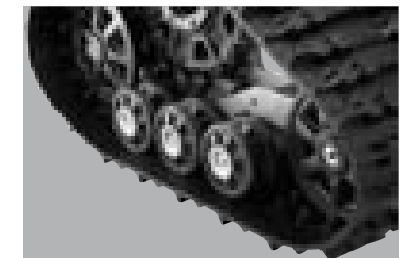

75% more wheels in contact with the ground at all time providing increased support and track durability.

New tread pattern and wider 14" rear track for 2010.

36 cm width

**OUTSIDE VIEW**  
Prospector Pro SR Tracks



ORDERING IS EASY

**STEP 1**

SELECT A TRACK MOUNT

**STEP 2**

SELECT A TRACK KIT

### 1 SELECT A TRACK MOUNT

#### PROSPECTOR TRACK MOUNT KIT

PART NO. 2876904

FITMENT MY 05-08, 09 CREW

PART NO. 2877053

FITMENT MY 09 4x4, XP, HD, CREW

PART NO. 2878075

FITMENT MY 10 4x4, XP, HD, CREW

### 2 SELECT A TRACK KIT

#### PROSPECTOR PRO-SR TRACK KIT

- Fine-tuned gear ratio to optimize track spin
- Long rear footprint for superior flotation

PART NO. 2878074

FITMENT ALL RANGERS

NOT AVAILABLE UNTIL LATE FALL.

## HOW PROSPECTOR PRO SR STACKS UP

### FEATURES:

Tested and esigned for the Ranger by the makers of the Ranger\*.

14" wide tracks for the rear units.

Improved load distribution to increase support and enhanced track durability. There are 75% more wheels in contact with the ground at all time.

Greasable hub for easy maintenance.

Thicker and heavier duty track for use with the Ranger loads.

Large diameter drive sprocket for great speed, without compromising stability and ground clearance. Power comes from the engine, without over revving.

Track is designed to give outstanding traction in various conditions.

Perfectly designed approach angle for maximizing climbing over large objects.

		TATOU <sup>™</sup> 4S	MATRACKS <sup>™</sup>
Tested and esigned for the Ranger by the makers of the Ranger*.	✓	✗	✗
14" wide tracks for the rear units.	✓	✗	✗
Improved load distribution to increase support and enhanced track durability. There are 75% more wheels in contact with the ground at all time.	✓	✗	✗
Greasable hub for easy maintenance.	✓	✗	✗
Thicker and heavier duty track for use with the Ranger loads.	✓	✗	✓
Large diameter drive sprocket for great speed, without compromising stability and ground clearance. Power comes from the engine, without over revving.	✓	✗	✗
Track is designed to give outstanding traction in various conditions.	✓	✗	✗
Perfectly designed approach angle for maximizing climbing over large objects.	✓	✗	✗

[WWW.PUREPOLARIS.COM](http://WWW.PUREPOLARIS.COM)



EXPERIENCE PROSPECTOR PRO TRACKS IN FULL MOTION VIDEO.



\* Tatou® is the registered trademark of Tatou, Inc. Matracks® is the registered trademark of Trade Division of National Transmission.

- CAB SELECTOR **NEW**  
PG. 06 - 07
- CABS **NEW**  
PG. 08 - 31
- RANGER 400 **NEW**  
PG. 32 - 41
- CAB COMPONENTS  
PG. 42 - 43
- CAB ACCESSORIES  
PG. 44 - 45
- WINCHES  
PG. 46 - 47
- LIFT + CARRY  
PG. 48 - 49
- PLOWS / SUSPENSION  
PG. 50 - 53
- BOX ACCESSORIES  
PG. 54 - 55
- STORAGE / RACKS  
PG. 56 - 58
- COVERS  
PG. 58 - 59
- HUNTING  
PG. 60
- LIGHTING  
PG. 61
- PROTECTION  
PG. 62 - 65
- COMFORT / STYLE  
PG. 66 - 67
- TRACKS / WHEELS  
PG. 68 - 73
- FIRE + RESCUE **NEW**  
PG. 74 - 75
- FIT CHARTS  
PG. 190 - 203



## RIMS & TIRES

**TIRES MAKE THE TRACTION. RIMS MAKE THE MACHINE.** How much traction you need depends on how and where you ride. That's why Pure Polaris offers such a wide variety of tires, including 26" Maxxis® Bighorn™ Tires mounted on our all-new 14" Machined and Flat Black SIXr Rims. And when it comes to rims, you can choose from a huge selection, many available in black or silver. Buy just the rims or go with the complete tire/rim package. Either way, you know you're riding on high-quality products from Pure Polaris.



**NEW  
2010**



### A. 36 CM SIXr RIMS WITH 66 CM MAXXIS® BIGHORN™ TIRES

- Our newest custom rims feature a dual 6-spoke design
- Radial construction creates a smooth ride on dirt, rocks and desert
- Features extra lugs on shoulder to protect sidewall and rim
- Raised lettering on one side
- Lug nuts sold separately

#### 36 CM FLAT BLACK SIXr RIMS WITH 66 CM MAXXIS® BIGHORN® TIRES

PART NO. 2878030  
 QUANTITY Set of 4  
 RIM SPEC 36 cm x 18 cm (Front); 36 cm x 20 cm (Rear)  
 TIRE SPEC 66 cm x 23 cm x 36 cm (Front); 66 cm x 28 cm x 36 cm (Rear)  
 FITMENT MY 05-10 (except 6x6)

#### 36 CM MACHINED SIXr RIMS WITH 66 CM MAXXIS® BIGHORN® TIRES

PART NO. 2878032  
 QUANTITY Set of 4  
 RIM SPEC 36 cm x 18 cm (Front); 36 cm x 20 cm (Rear)  
 TIRE SPEC 66 cm x 23 cm x 36 cm (Front); 66 cm x 28 cm x 36 cm (Rear)  
 FITMENT MY 05-10 (except 6x6)



### B. 36 CM CRUSHER RIMS WITH MAXXIS® BIGHORN™ TIRES

- Custom 8-spoke Crusher Rim design is a Polaris exclusive
- Radial construction creates a smooth ride on dirt, rocks and desert
- Features extra lugs on shoulder to protect sidewall and rim
- Raised lettering on one side
- Lug nuts sold separately

#### 36 CM BLACK CRUSHER RIMS WITH 66 CM MAXXIS® BIGHORN® TIRES

PART NO. 2877159  
 QUANTITY Set of 4  
 RIM SPEC 36 cm x 18 cm (Front); 36 cm x 20 cm (Rear)  
 TIRE SPEC 66 cm x 23 cm x 36 cm (Front); 66 cm x 28 cm x 36 cm (Rear)  
 FITMENT MY 05-10 (except 6x6)

#### 36 CM SILVER CRUSHER RIMS WITH 66 CM MAXXIS® BIGHORN® TIRES

PART NO. 2876907  
 QUANTITY Set of 4  
 RIM SPEC 36 cm x 18 cm (Front); 36 cm x 20 cm (Rear)  
 TIRE SPEC 66 cm x 23 cm x 36 cm (Front); 66 cm x 28 cm x 36 cm (Rear)  
 FITMENT MY 05-10 (except 6x6)



### C. 36 CM-38 CM BUCKSHOT RIMS WITH VISION TRAILFINDER™ TIRES

- Unique, automotive-inspired, 8-spoke Buckshot design
- Choose 36 cm or industry's first 38 cm rims
- Tread pattern delivers excellent mud, trail and off-road performance
- Lug nuts sold separately

#### 38 CM BUCKSHOT RIMS WITH 66 CM VISION TRAILFINDER TIRES

PART NO. 2877604  
 QUANTITY Set of 4  
 RIM SPEC 38 cm x 18 cm (Front); 38 cm x 20 cm (Rear)  
 TIRE SPEC 66 cm x 26 cm x 38 cm (Front); 66 cm x 30 cm x 38 cm (Rear)  
 FITMENT MY 05-08 (except 6x6)

#### 36 CM BUCKSHOT RIMS WITH 66 CM VISION TRAILFINDER™ TIRES

PART NO. 2877605  
 QUANTITY Set of 4  
 RIM SPEC 36 cm x 18 cm (Front); 36 cm x 20 cm (Rear)  
 TIRE SPEC 66 cm x 26 cm x 36 cm (Front); 66 cm x 30 cm x 36 cm (Rear)  
 FITMENT MY 05-10 (except 6x6)



### D. 36 CM BRUISER RIMS WITH MAXXIS® BIGHORN™ TIRES

- Beefy, 4-spoke Bruiser Rim design is a Polaris exclusive
- Radial construction creates a smooth ride on dirt, rocks and desert
- Features extra lugs on shoulder to protect sidewall and rim
- Raised lettering on one side
- Lug nuts sold separately

PART NO. 2876944  
 QUANTITY Set of 4  
 RIM SPEC 36 cm x 18 cm (Front); 36 cm x 20 cm (Rear)  
 TIRE SPEC 66 cm x 23 cm x 36 cm (Front); 66 cm x 23 cm x 36 cm (Rear)  
 FITMENT MY 05-10 (except 6x6)



# RIMS & TIRES

## A. 36 CM-38 CM BUCKSHOT RIMS

- Unique, automotive-inspired, 8-spoke Buckshot design
- Choose 36 cm or industry's first 38 cm rims

### 38 CM BUCKSHOT RIMS

PART NO.	1521431
SPEC	Front 38 cm x 18 cm
PART NO.	1521432
SPEC	Rear 38 cm x 20 cm
FITMENT	Does not fit MY 09-10

### 36 CM BUCKSHOT RIMS

PART NO.	1521433
SPEC	Front 36 cm x 18 cm
PART NO.	1521434
SPEC	Rear 36 cm x 20 cm
FITMENT	All models

## B. 36 CM CRUSHER RIMS

- Custom 8-spoke Crusher Rim design is a Polaris exclusive
- Cast aluminum for strength, and light weight

### 36 CM BLACK CRUSHER RIMS

PART NO.	2877157
SPEC	Front 36 cm x 18 cm
PART NO.	2877158
SPEC	Rear 36 cm x 20 cm
FITMENT	All models

### 36 CM SILVER CRUSHER RIMS

PART NO.	2876281
SPEC	Front 36 cm x 18 cm
PART NO.	2876282
SPEC	Rear 36 cm x 20 cm
FITMENT	All models

## C. 36 CM SIXr RIMS

- Our newest custom rim features a dual 6-spoke design
- Choose flat black or machined

### 36 CM SIXr FLAT BLACK RIMS

PART NO.	1521507-521
SPEC	Front 36 cm x 18 cm
PART NO.	1521508-521
SPEC	Rear 36 cm x 20 cm
FITMENT	All models

### 36 CM SIXr MACHINED RIMS

PART NO.	1521507-521
SPEC	Front 36 cm x 18 cm
PART NO.	1521508-266
SPEC	Rear 36 cm x 20 cm
FITMENT	All models



## D. 31 CM- 36 CM BRUISER RIMS

- Beefy, 4-spoke Bruiser Rim design is a Polaris exclusive
- Cast aluminum for strength, and light weight

### 36 CM BRUISER RIMS

PART NO.	2875904
SPEC	Front 36 cm x 18 cm
PART NO.	2875905
SPEC	Rear 36 cm x 20 cm
FITMENT	All models

## E. 31 CM CAST ALUMINUM RIMS

- Classic 8-spoke design, a Polaris exclusive
- Cast aluminum for strength, and light weight
- Machined center cap within the wheel

### 31 CM BRUISER RIMS

PART NO.	2876086
SPEC	Front 31 cm x 15 cm
PART NO.	2876087
SPEC	Rear 31 cm x 20 cm
FITMENT	All models

### 31 CM BRUISER RIMS

PART NO.	2875902
SPEC	Front 31 cm x 18 cm
PART NO.	2875903
SPEC	Rear 31 cm x 20 cm
FITMENT	All models

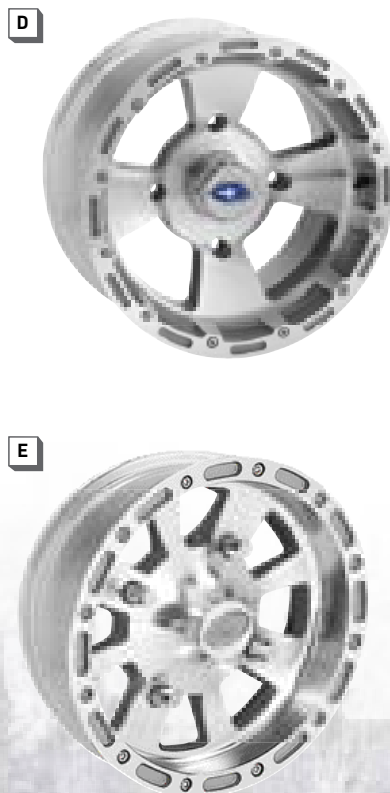

## E. MAXXIS® BIGHORN® TIRES

- Radial construction creates a smooth ride on dirt, rocks and desert
- Features extra lugs on shoulder to protect sidewall and rim
- Raised lettering on one side

PART NO.	2876905
SPEC	Front 66 cm x 22 cm x 36 cm
FITMENT	36 cm x 18 cm Front Wheel
PART NO.	2876906
SPEC	Rear 66 cm x 30 cm x 36 cm
FITMENT	36 cm x 20 cm Rear Wheel

## F. 36 CM-36 CM VISION TRAILFINDER® TIRES

- Tread pattern delivers a smooth ride on the trail
- Excellent mud and off-road performance

PART NO.	5413726
SPEC	Front 66 cm x 25 cm x 38 cm
FITMENT	38 cm x 18 cm Front Wheel
PART NO.	5413727
SPEC	Rear 66 cm x 31 cm x 38 cm
FITMENT	38 cm x 20 cm Rear Wheel
PART NO.	5413659
SPEC	Front 66 cm x 25 cm x 36 cm
FITMENT	36 cm x 18 cm Front Wheel
PART NO.	5413660
SPEC	Rear 66 cm x 31 cm x 36 cm
FITMENT	36 cm x 20 cm Rear Wheel

## G. 36 CM GOODYEAR® MTR TIRES

- Features an aggressive mud-tire tread pattern
- Delivers sharp steering response and all-day comfort
- 6-ply rating

PART NO.	2875906
SPEC	Front 64 cm x 22 cm x 36 cm
FITMENT	31 cm x 18 cm Front Wheel
PART NO.	2875907
SPEC	Rear 64 cm x 25 cm x 36 cm
FITMENT	31 cm x 20 cm Rear Wheel

## H. CARLISLE® ACT TIRES

- Rugged tire features 6-ply construction
- Rim-saver protects from rocks and debris
- Dimple tread surface improves traction

PART NO.	2876084
SPEC	Front 58 cm x 18 cm x 31 cm
FITMENT	31 cm x 18 cm Front Wheel
PART NO.	2876085
SPEC	Rear 58 cm x 25 cm x 31 cm
FITMENT	31 cm x 20 cm Rear Wheel

## I. SPORTSMAN LOAD BOSS TURF TIRES

- Six-ply turf tires are perfect for driving on lawns while mowing or hauling
- Avoids damage by dispersing tire pressure across turf-tread pattern
- Tires fit on 12" stock rims (not included)
- Tires sold individually, lug nuts sold separately

PART NO.	2875796
SPEC	Front 25" x 8" x 12"
FITMENT	
PART NO.	2875795
SPEC	Rear 25" x 10" x 12"
FITMENT	



### SAE LUG NUTS FOR ALUMINUM RIMS

PART NO.	2876754
QUANTITY	Set of 4
PART NO.	2877409
QUANTITY	Set of 16

### METRIC LUG NUTS FOR ALUMINUM RIMS

PART NO.	2877385
QUANTITY	Set of 4
PART NO.	2877384
QUANTITY	Set of 16

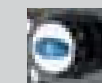

### BRUISER & CRUSHER CENTER CAP

PART NO.	2854604
----------	---------



### CHROME SIXr CENTER CAP

PART NO.	1521509-410
----------	-------------

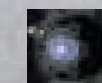

### FLAT BLACK SIXr CENTER CAP

PART NO.	1521509-521
----------	-------------



# FIRE + RESCUE

**PERFORMANCE PARTNERSHIP.** Polaris was the first to introduce a hard-working, smooth-riding utility vehicle (UTV). RKO Enterprises was the first to introduce UTV-mounted Fire & Rescue platforms. Our two companies have teamed up to offer the ultimate off-road Fire & Rescue vehicles, designed to reach fires and emergency situations in areas with limited access and rugged terrain. All of these carefully engineered RKO Enterprises platforms are of the highest quality. They are designed to be used in the Polaris RANGER 6x6, featuring industry-leading utility, capacity and traction. Even fully loaded, the RANGER 6x6 delivers a smooth ride over rugged terrain, thanks to fully independent suspensions and true 6-wheel drive. Choose from a variety of Fire & Rescue Units to suit your exact needs.



## A. RKO RESCUE SKID UNIT SLIP IN UNIT

- Made to fit Polaris RANGER 4x4 or 6x6
- Heavy-duty aluminum construction
- RKO-Junkin rescue system
- Entire unit is removable

### WITH ATTENDANT SEAT

PART NO. 2859972

FITMENT All RANGER 4x4, 6x6

### WITHOUT ATTENDANT SEAT

PART NO. 2859971

FITMENT All RANGER 4x4, 6x6



A

## B. RKO UTILITY FIRE RESCUE SLIP IN UNITS

- 360 L gallon Copoly tank w/19 L integral foam cell
- RKO Quick Quench foam system
- Darley/Davey high performance fire pump system
- RKO stainless steel piping with lifetime warranty
- Hannay hose reel with 21 m of 2 cm Red Booster hose
- 10-30 forestry nozzle
- RKO - Junkin rescue system
- Capable drafting to 18'
- 4 cm Discharge 2.5 cm Discharge 2.5 cm Recirc-Fill 2.5 cm to Hose Reel

PART NO. 2859976 | WITH HONDA 5.5HP

FITMENT All RANGER 6x6

PART NO. 2859977 | WITH BRIGGS 9HP

FITMENT All RANGER 6x6

PART NO. 2859978 | WITH HONDA 9HP

FITMENT All RANGER 6x6



B

## C. RKO DELUXE RESCUE SKID SLIP IN UNIT

- Available in heavy-duty aluminum construction or corrosion resistant copoly skid system
- Low profile design
- Patient Transport System with Junkin JSA200 stokes basket
- Adjustable attendant seat with seat belt
- Storage drawer under patient transport system with door
- 0<sup>2</sup> bottle holder
- 2 IV bag clips

PART NO. 2859970

FITMENT All RANGER 6x6



C

## D. RKO FAST ATTACK UTILITY VEHICLE FIRE UNITS

- 265 L copoly tank w/19 L integral foam cell
- RKO quick quench foam system
- Darley/Davey high-performance fire pump system
- RKO stainless steel piping with lifetime warranty
- Hannay hose reel with 21 m of 2 cm Red Booster hose and 2.5 cm forestry nozzle
- Discharge pressure gauge
- 4 cm Discharge 2.5 cm Discharge 2.5 cm Recirc-Fill 2.5 cm to Hose Reel
- Capable of drafting to 18'

PART NO. 2859973 | WITH HONDA 5.5HP

FITMENT All RANGER 4x4, 6x6

PART NO. 2859974 | WITH BRIGGS 9HP

FITMENT All RANGER 4x4, 6x6

PART NO. 2859975 | WITH HONDA 9HP

FITMENT All RANGER 4x4, 6x6



D

Pricing does not include shipping or installation charges. See your local Polaris dealer for a price quote on installation time and cost. Allow 6-8 weeks for delivery. » For questions email [fire.rescue@polarisind.com](mailto:fire.rescue@polarisind.com)

CAB SELECTOR NEW  
PG. 06 - 07

CABS NEW  
PG. 08 - 31

RANGER 400 NEW  
PG. 32 - 41

CAB COMPONENTS  
PG. 42 - 43

CAB ACCESSORIES  
PG. 44 - 45

WINCHES  
PG. 46 - 47

LIFT + CARRY  
PG. 48 - 49

PLOWS / SUSPENSION  
PG. 50 - 53

BOX ACCESSORIES  
PG. 54 - 55

STORAGE / RACKS  
PG. 56 - 58

COVERS  
PG. 58 - 59

HUNTING  
PG. 60

LIGHTING  
PG. 61

PROTECTION  
PG. 62 - 65

COMFORT / STYLE  
PG. 66 - 67

TRACKS / WHEELS  
PG. 68 - 73

FIRE + RESCUE NEW  
PG. 74 - 75

FIT CHARTS  
PG. 190 - 203



CAB SELECTOR **NEW**  
PG. 78 - 79

CABS **NEW**  
PG. 80 - 87

ROOFS & WINDSHIELDS  
PG. 88 - 89

PROTECTION  
PG. 90 - 95

PLOWS & WINCHES  
PG. 96 - 97

STORAGE  
PG. 98 - 101

PERFORMANCE  
PG. 102 - 103

RIMS & TIRES  
PG. 104 - 107

TRACKS  
PG. 108

LIGHTING  
PG. 109

GRAPHICS  
PG. 110

AUDIO  
PG. 111

CUSTOM  
PG. 112 - 113

FIT CHARTS  
PG. 190 - 203



**MAKE RIDING MORE FUN.** Whether you're riding the dunes, exploring the trails, heading for deer camp or plowing the driveway, Pure Polaris has everything you need to customize your *RANGER RZR* or *RANGER RZR S*. Custom rims, rally lights and sound systems, it's all here. Designed by Polaris engineers, so you know it installs easy, it fits and it lasts.



# RANGER RZR® CAB SELECTOR

>>>

## HOW TO SELECT THE CAB THAT IS RIGHT FOR ME.

Choosing cab components for your RANGER RZR® is easy as 1-2-3:

1. What type of cab fits your needs and climate?
2. Which cab components fit your RANGER RZR?
3. Which cab components do you need today?

You can purchase cab components along with your RANGER RZR, and also add components later. It's as easy as 1-2-3.



	RANGER MODELS:	KEY FEATURES:	FEATURE COMPARISONS:
<b>FIBERGLASS</b>	<input type="checkbox"/> RANGER RZR	<ul style="list-style-type: none"> <li>» Automotive-quality fit &amp; finish with color options</li> <li>» Carpet lining dampens interior sound</li> <li>» Interior dome and exterior work lights</li> <li>» Oversized windows for greater visibility</li> </ul>	
	<input type="checkbox"/> RANGER RZR S		
<b>STEEL</b>	<input type="checkbox"/> RANGER RZR	<ul style="list-style-type: none"> <li>» Strong, tough &amp; durable</li> <li>» Delivers the best all-season protection and comfort</li> <li>» Easy-on/off doors have premium latches</li> <li>» Oversized window for greater visibility</li> </ul>	
	<input type="checkbox"/> RANGER RZR S		
<b>POLY</b>	<input type="checkbox"/> RANGER RZR	<ul style="list-style-type: none"> <li>» Durable &amp; lightweight</li> <li>» Versatile year-round comfort</li> <li>» Best value hard cab</li> <li>» Maximum ventilation with rear sliding window and vent</li> <li>» Windows on door bottoms for visibility</li> </ul>	
	<input type="checkbox"/> RANGER RZR S		
<b>CANVAS</b>	<input type="checkbox"/> RANGER RZR	<ul style="list-style-type: none"> <li>» Lightweight, easy-on/off</li> <li>» Ideal for warm-weather use</li> <li>» Durable 600-denier polyester</li> <li>» Excellent ventilation with zip-out windows</li> </ul>	
	<input type="checkbox"/> RANGER RZR S		

# BUILD YOUR CAB

**STAGE 1 WINDSHIELD**

- » Protects & ensures visibility
- » Blocks wind, rain and debris
- » Easy to install
- » Accessory wiper available (for glass windshields only)

**STAGE 2 ROOF**

- » Overhead protection
- » Blocks sun, rain, branches
- » Fits securely to vehicle frame
- » Provides multi-season comfort

**REAR PANEL**

- » Reduces low pressure and dust behind windshield
- » Blocks shifting cargo in box
- » Rear window for better visibility
- » Seals securely to vehicle frame

**STAGE 3 DOORS**

- » Create complete interior environment
- » Adds security and protection
- » Gives cab a finished, automotive style

**STAGE 4 ACCESSORIES**

- » For comfort, add a fan, heater, stereo & more

PAGE NO.
SEE THE RANGERWARE CAB ON PAGES: 80-81
PAGE NO.
SEE THE STEEL CAB ON PAGES: 82-83
PAGE NO.
SEE THE POLY CAB ON PAGES: 84-85
PAGE NO.
SEE THE CANVAS CAB ON PAGE: 86

CAB SELECTOR <b>NEW</b> PG. 78 - 79
CABS <b>NEW</b> PG. 80 - 87
ROOFS & WINDSHIELDS PG. 88 - 89
PROTECTION PG. 90 - 95
PLOWS & WINCHES PG. 96 - 97
STORAGE PG. 98 - 101
PERFORMANCE PG. 102 - 103
RIMS & TIRES PG. 104 - 107
TRACKS PG. 108
LIGHTING PG. 109
GRAPHICS PG. 110
AUDIO PG. 111
CUSTOM PG. 112 - 113
FIT CHARTS PG. 190 - 203

Note: For cab component fitment on pre-model year 2010 RANGER RZR, refer to component descriptions in this catalog or consult your local Polaris dealer.

# RANGERWARE™ BY POLARIS

» **SUPERIOR STYLE AND PROTECTION.** RANGERWARE™ By Polaris complements RANGER RZR and RANGER RZR S styling with its high-gloss, automotive-quality finish – in red or black. The hand-laid fiberglass cab components are strong, durable and they form a seal that creates a protective, comfortable cab interior. Open door frames optimizes ventilation for rider comfort.

» **BEST FOR: TRAIL, SPORT & HUNT**

## » KEY FEATURES

### » WEATHER PROTECTION

- Components form a tight seal
- Accessories (heater, fan) add even more comfort

### » DURABILITY

- Durable hand-laid fiberglass construction
- Can withstand rigors of aggressive driving
- Strong, durable, reliable cab components

### » FIT & FINISH

- Automotive-quality fit & finish
- Premium gloss finish in Red or Black
- Oversized windows for maximum visibility

### » INTERIOR CARPET

- Commercial-grade carpet insulation
- Dampens sound for rider comfort
- Cushions interior surfaces for riders

### » VENTILATION

- Open door frames optimize ventilation

RANGERWARE™ BY POLARIS >  
SHOWN ON RZR MODEL (FRONT)



Large windshield maximizing visibility

Lightweight design for easy on/off

Carpeted interior adds comfort and sound dampening

**NEW 2010**

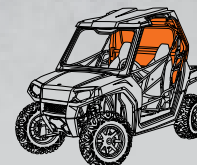
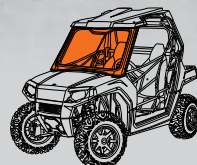

### ORDERING IS EASY

#### STAGE 1

**SELECT A WINDSHIELD**  
To add dust and wind protection.

#### STAGE 2

**SELECT A ROOF**  
For rain and sun protection.

#### STAGE 3

**SELECT A REAR PANEL**  
To minimize pressure and dust behind windshield.

#### STAGE 4

**SELECT ACCESSORIES**  
Let you control the environment inside the cab

Interior dome lights

Stylish fiberglass construction

Exterior rear work lights add visibility at night



RANGERWARE™ BY POLARIS SHOWN ON RZR MODEL (REAR)

RANGERWARE™ BY POLARIS CAB >  
AVAILABLE IN RED, OR BLACK



## BUILD YOUR CAB

STEP 1

### SELECT A WINDSHIELD

#### RANGERWARE™ BY POLARIS WINDSHIELD

##### BLACK RANGERWARE™ BY POLARIS WINDSHIELD

PART NO. 2878057-070

FITMENT RANGER RZR MY 08-10, RANGER RZR S MY 09-10

##### RED RANGERWARE™ BY POLARIS WINDSHIELD

PART NO. 2878057-293

FITMENT RANGER RZR MY 08-10, RANGER RZR S MY 09-10

#### GLASS WINDSHIELD WIPER

PART NO. 2876854

FITMENT RANGER RZR MY 08-10, RANGER RZR S MY 09-10

STEP 2

### SELECT A ROOF

#### RANGERWARE™ BY POLARIS ROOF

##### BLACK RANGERWARE™ BY POLARIS ROOF

PART NO. 2878051-070

FITMENT RANGER RZR MY 08-10, RANGER RZR S MY 09-10

##### RED RANGERWARE™ BY POLARIS ROOF

PART NO. 2878051-293

FITMENT RANGER RZR MY 08-10, RANGER RZR S MY 09-10

STEP 3

### SELECT A REAR PANEL

#### RANGERWARE™ BY POLARIS REAR PANEL

##### BLACK RANGERWARE™ BY POLARIS REAR PANEL

PART NO. 2878056-070

FITMENT RANGER RZR MY 08-10

PART NO. 2878067-070

FITMENT RANGER RZR S MY 09-10

##### RED RANGERWARE™ BY POLARIS REAR PANEL

PART NO. 2878056-293

FITMENT RANGER RZR MY 08-10

### BUILD YOUR ULTIMATE RANGER RZR ONLINE

LOG ON TO [WWW.BUILDMYRZR.COM](http://WWW.BUILDMYRZR.COM) and deck out your RANGER RZR with Pure Polaris accessories. Once you've built your ultimate machine, print out the summary and bring to your nearest Polaris Dealer and make your dream a reality.



### CUSTOMIZE YOUR RIDE FURTHER WITH CAB ACCESSORIES

- UNDERDASH HEATER PG. 87
- REAR VIEW MIRROR PG. 87
- UNDERDASH BLOCKOFF KIT PG. 87
- HORN KIT PG. 87

CAB SELECTOR NEW  
PG. 78 - 79

CABS NEW  
PG. 80 - 87

ROOFS & WINDSHIELDS  
PG. 88 - 89

PROTECTION  
PG. 90 - 95

PLOWS & WINCHES  
PG. 96 - 97

STORAGE  
PG. 98 - 101

PERFORMANCE  
PG. 102 - 103

RIMS & TIRES  
PG. 104 - 107

TRACKS  
PG. 108

LIGHTING  
PG. 109

GRAPHICS  
PG. 110

AUDIO  
PG. 111

CUSTOM  
PG. 112 - 113

FIT CHARTS  
PG. 190 - 203



# STEEL CAB

**NO TERRAIN TOO TOUGH.** The RANGER RZR Steel Cab delivers the greatest protection, keeping riders secure and comfortable inside a tough, durable cab no matter how gnarly the terrain and surroundings get outside. The windshield and windows deliver excellent visibility. When riding conditions and the climate permit, remove the doors – no tools required – and enjoy maximum airflow through the cab.

» **BEST FOR: WORK & HEAVY-DUTY USE**

## » KEY FEATURES

### » WEATHER PROTECTION

- Tough steel can withstand any type of weather
- Components form a tight seal
- Easy-to-install doors seal & latch securely

### » DURABILITY

- The most durable cab components
- Tough enough for work, sport & trail
- Can withstand rough terrain, aggressive driving

### » FIT & FINISH

- Top-quality fit & finish
- Components fit together to form sealed interior
- "A" pillar window for visibility & interior light

### » VENTILATION

- Doors remove easily when not needed
- Driving without doors optimizes ventilation

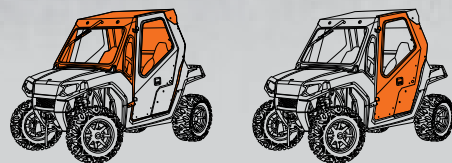

### ORDERING IS EASY

#### STEP 1

**SELECT A CAB**  
Includes roof, rear panel and windshield

#### STEP 2

**SELECT A DOOR KIT**  
Optional (sold separately)

**NEW 2010**



Roof indented for easy in/out



STEEL CAB SHOWN ON RZR MODEL (FRONT)

Made of 16 ga. steel for industrial-strength quality and protection



STEEL CAB SHOWN ON RZR S MODEL (REAR)

#### STAGE 3

**SELECT ACCESSORIES**  
Let you control the environment inside the cab

Durable wrinkle-black finish for long-lasting beauty



STEEL CAB SHOWN ON RZR MODEL (REAR)

#### STEEL CAB LATCHES:



Premium paddle-style latches are built flush with the door, easy to open and close, and keep the doors securely latched when riding over rough terrain.

## BUILD YOUR CAB

### STEP 1 SELECT A CAB

#### STEEL CAB

- Made of 16 ga. steel for industrial-strength and protection
- Includes roof, automotive-glass windshield, rear panel (doors sold separately)
- Durable wrinkle-black finish for long-lasting beauty
- Roof and rear panel designed to fit RZR and RZR S cage

PART NO. 2877963

FITMENT RANGER RZR MY 08-10, RANGER RZR S MY 09-10

### STEP 2 SELECT A DOOR KIT

#### STEEL CAB DOOR KIT

PART NO. 2877964

FITMENT RANGER RZR MY 08-10, RANGER RZR S MY 09-10

#### ! ATTENTION

MY 2008 RZR must order 2859966 Side Bar Update Kit.



#### STEEL CAB WIPER KIT

- Integrates into steel roof
- Wiper motor hidden behind interior panel
- Includes wiring and switch

PART NO. 2877965

FITMENT RANGER RZR MY 08-10, RANGER RZR S MY 09-10

#### POLARIS AUXILIARY SWITCH

- Wire additional components to interior panel

PART NO. 4011500

### BUILD YOUR ULTIMATE RANGER RZR ONLINE

LOG ON TO [WWW.BUILDMYRZR.COM](http://WWW.BUILDMYRZR.COM) and deck out your RANGER RZR with Pure Polaris accessories. Once you've built your ultimate machine, print out the summary and bring to your nearest Polaris Dealer and make your dream a reality.



#### CUSTOMIZE YOUR RIDE FURTHER WITH CAB ACCESSORIES

- UNDERDASH HEATER PG. 87
- REAR VIEW MIRROR PG. 87
- UNDERDASH BLOCKOFF KIT PG. 87
- HORN KIT PG. 87

# POLY CAB

>>>

**OUR BEST YET.** The all-new RANGER RZR Poly Cab is our most advanced full-cab enclosure ever. It's perfect for anyone who wants maximum protection with minimum weight. All pieces integrate seamlessly with one another, creating a flat plane and a superior seal at the doors and windows. Large windows, including those on the lower half of doors, maximize interior brightness and external visibility. The roof and rear panel quickly attach using cab frame hooks and Lock & Ride® clamps. The new door design features dual hinges and premium latches. Components are made of durable polyethylene, with great fit and finish.

» **BEST FOR: MULTI-PURPOSE USE**

## » KEY FEATURES

- Best value hard cab
- Maximum ventilation with rear sliding window and vent
- New component designs create superior protection and visibility
- Steel frames on doors and pillars provide strength and durability
- Doors feature clear, screen-printed poly for side visibility
- Complete cab kit includes roof, doors and rear panel
- Works with poly or glass windshield, sold separately

## BUILD YOUR CAB

### STEP 1 SELECT A CAB

#### POLY CAB (INCLUDES: ROOF, DOORS & REAR PANEL)

PART NO. 2877960  
 FITMENT RANGER RZR MY 08-10 RZR  
 PART NO. 2877961  
 FITMENT RANGER RZR S MY 09-10

#### ! ATTENTION

MY 2008 RZR must order 2859966 Side Bar Update Kit.

POLY CAB SHOWN ON >  
 RZR MODEL (FRONT)



**NEW**  
 2010

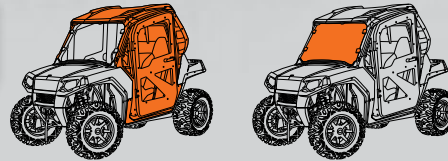

### ORDERING IS EASY

#### STEP 1

SELECT A CAB  
 Includes roof, doors  
 and rear panel.

#### STEP 2

SELECT A WINDSHIELD  
 Works with Lock & Ride®,  
 or glass windshield.

#### STAGE 3

SELECT ACCESSORIES  
 Let you control the  
 environment inside  
 the cab

POLY CAB SHOWN ON >  
 RZR MODEL (REAR)



Steel frames on doors  
 and pillars provide  
 strength and durability

New component  
 designs create superior  
 protection and visibility

Sliding rear window  
 for ventilation and  
 access to trunk

### POLY CAB LATCHES:



Automotive style lockable latches keep doors securely closed while working, hunting or riding off-road.

Doors feature clear,  
 screen-printed poly  
 for side visibility



POLY CAB SHOWN ON >  
 RZR S MODEL (REAR)

#### GLASS WINDSHIELD WIPER

PART NO. 2876854  
 FITMENT RANGER RZR MY 08-10, RANGER RZR S MY 09-10

#### CUSTOMIZE YOUR RIDE FURTHER WITH CAB ACCESSORIES

- UNDERDASH HEATER PG. 87
- REAR VIEW MIRROR PG. 87
- UNDERDASH BLOCKOFF KIT PG. 87
- HORN KIT PG. 87

CAB SELECTOR NEW  
 PG. 78 - 79

CABS NEW  
 PG. 80 - 87

ROOFS & WINDSHIELDS  
 PG. 88 - 89

PROTECTION  
 PG. 90 - 95

PLOWS & WINCHES  
 PG. 96 - 97

STORAGE  
 PG. 98 - 101

PERFORMANCE  
 PG. 102 - 103

RIMS & TIRES  
 PG. 104 - 107

TRACKS  
 PG. 108

LIGHTING  
 PG. 109

GRAPHICS  
 PG. 110

AUDIO  
 PG. 111

CUSTOM  
 PG. 112 - 113

FIT CHARTS  
 PG. 190 - 203



# CANVAS CAB

**EASY ON/OFF.** The canvas cab is ideal for anyone who wants to keep riding even when the weather turns bad. It's easy to put on and take off, and provides lightweight, wraparound protection from wind and rain, complete with zip-out windows and detachable doors.

## » BASIC USE

### » KEY FEATURES

- Lightweight, with easy on/off design
- Features fully-framed doors, tubular-framed soft top
- Zip-out windows, large rear-panel window
- Durable 600 denier, solution-dyed polyester

## BUILD YOUR CAB

### STEP 1 SELECT A CAB

#### CANVAS CAB (INCLUDES: ROOF, DOORS & REAR PANEL)

PART NO. 2877872  
FITMENT RANGER RZR 08-10, RANGER RZR S 09-10

### STEP 2 SELECT A WINDSHIELD

SEE PG. 89 FOR MORE INFO

#### LOCK & RIDE® WINDSHIELD

PART NO. 2876524  
FITMENT RANGER RZR MY 08-10, RANGER RZR S MY 09-10

#### GLASS WINDSHIELD

PART NO. 2877420  
FITMENT RANGER RZR MY 08-10, RANGER RZR S MY 09-10

#### GLASS WINDSHIELD WIPER

PART NO. 2876854  
FITMENT RANGER RZR 08-10, RANGER RZR S 09-10

CANVAS CAB SHOWN >  
ON RZR MODEL (FRONT)



Features fully-framed  
doors, tubular-framed  
soft top

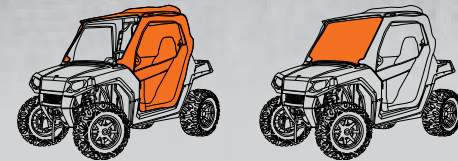

### ORDERING IS EASY

#### STEP 1

SELECT A CAB  
Includes roof, doors  
and rear panel.

#### STEP 2

SELECT A WINDSHIELD  
Works with Lock & Ride®,  
or glass windshield.

#### STAGE 3

SELECT ACCESSORIES  
Let you control the environment inside the cab

Durable 600 denier,  
solution-dyed polyester

Zip-out windows, large  
rear-panel window

# CAB ACCESSORIES



#### A. UNDERDASH HEATER

- Heats cab area when engine is running
- Connects to power supply
- Heater core can be turned off for interior air movement

PART NO. 2876451  
FITMENT RANGER RZR MY 08-10, RANGER RZR S MY 09-10

#### B. UNDERDASH BLOCKOFF KIT

- Blocks gap between floor and under the dash
- Reduces air flow, prevents gravel and water from entering

PART NO. 2876900  
FITMENT RANGER RZR MY 08-10, RANGER RZR S MY 09-10

#### C. REAR VIEW MIRROR

- Convex design delivers wide rear view
- Works with all roofs, soft tops and windshields

PART NO. 2876437  
FITMENT RANGER RZR MY 08-10, RANGER RZR S MY 09-10

#### D. HORN KIT

- Complete kit, connects to electrical system
- Includes dash-mounted button, wiring harness

PART NO. 2877788  
FITMENT RANGER RZR MY 08-10, RANGER RZR S MY 09-10

< CANVAS CAB  
SHOWN ON RZR  
MODEL (REAR)

< CANVAS CAB  
SHOWN ON RZR S  
MODEL (REAR)

CAB SELECTOR NEW  
PG. 78 - 79

CABS NEW  
PG. 80 - 87

ROOFS & WINDSHIELDS  
PG. 88 - 89

PROTECTION  
PG. 90 - 95

PLOWS & WINCHES  
PG. 96 - 97

STORAGE  
PG. 98 - 101

PERFORMANCE  
PG. 102 - 103

RIMS & TIRES  
PG. 104 - 107

TRACKS  
PG. 108

LIGHTING  
PG. 109

GRAPHICS  
PG. 110

AUDIO  
PG. 111

CUSTOM  
PG. 112 - 113

FIT CHARTS  
PG. 190 - 203

# ROOFS & WINDSHIELDS

**TOP OFF YOUR RANGER RZR.** Keep that open-air feeling while protecting you and your passenger from the sun, wind and rain. Mix and match from a wide variety of roofs and windshields.



- A. SPORT ROOF**
- Ideal for hunting and trail riding
  - Made of rugged, scratch-resistant, high-density polyethylene
  - Works with Lock & Ride® Windshield, Glass Windshield and Cloth or Poly Rear Panel

PART NO. 2876456  
 FITMENT RANGER RZR MY 08-10, RANGER RZR S MY 09-10

- B. BIMINI CAB TOP**
- Made of durable, marine-grade vinyl material
  - Easy attachment with quick-release buckles and Velcro® straps
  - Works with Lock & Ride® Windshield, Glass Windshield and Cloth or Poly Rear Panel
- PART NO. 2876434-070  
 FITMENT RANGER RZR MY 08-10, RANGER RZR S MY 09-10

- C. SOFT TOP**
- Combines strength, dimensional stability and fade resistance
  - Made of high-quality 600 denier solution-dyed polyester material
  - Works with Lock & Ride® Windshield, Glass Windshield and Cloth or Poly Rear Panel
- PART NO. 2876703  
 FITMENT RANGER RZR MY 08-10, RANGER RZR S MY 09-10



- D. HEADACHE NET**
- Adds sport styling and protection from cargo in box
  - Attaches with buckle system
  - Works with all roof combinations

PART NO. 2876441-070  
 FITMENT RANGER RZR MY 08-10, RANGER RZR S MY 09-10



- E. CLOTH REAR PANEL**
- Economical solution to reduce dust swirl behind windshield
  - Can be rolled up or down based on riding conditions
  - Works with all roof combinations

PART NO. 2877411  
 FITMENT RANGER RZR MY 08-10, RANGER RZR S MY 09-10



- F. POLY REAR PANEL**
- Clear polycarbonate, helps reduce dust swirl behind windshield
  - Attaches to rear cab frame with p-clamps
  - Works with all roof combinations

PART NO. 2877327  
 FITMENT RANGER RZR MY 08-10, RANGER RZR S MY 09-10



- G. LOCK & RIDE® WINDSHIELD**
- Snap clamps securely hold windshield to frame
  - Premium optical-grade polycarbonate with scratch-resistant hard-coat finish
  - Works with poly cab, canvas cab and any roof combination
- PART NO. 2876524  
 FITMENT RANGER RZR MY 08-10, RANGER RZR S MY 09-10



- H. GLASS WINDSHIELD**
- Offers excellent protection, features solid steel frame
  - Works with poly cab, canvas cab and any roof combination
  - Wiper sold separately
- PART NO. 2877420  
 FITMENT RANGER RZR MY 08-10, RANGER RZR S MY 09-10



- I. GLASS WINDSHIELD WIPER**
- Cleans windshield for improved off-road visibility
  - Kit includes wiring and hardware
- PART NO. 2876854  
 FITMENT RANGER RZR MY 08-10, RANGER RZR S MY 09-10



- J. HALF WINDSHIELD**
- Protection from wind and debris
  - Polycarbonate construction, with top lip to deflect air flow
  - Works with any roof or cab combination
- PART NO. 2876435  
 FITMENT RANGER RZR MY 08-10, RANGER RZR S MY 09-10

**! ATTENTION** Recommend cloth or poly rear panel to reduce dust swirl with all windshields

CAB SELECTOR  
 PG. 78-79

CABS  
 PG. 80-87

ROOFS & WINDSHIELDS  
 PG. 88-89

PROTECTION  
 PG. 90-95

PLOWS & WINCHES  
 PG. 96-97

STORAGE  
 PG. 98-101

PERFORMANCE  
 PG. 102-103

RIMS & TIRES  
 PG. 104-107

TRACKS  
 PG. 108

LIGHTING  
 PG. 109

GRAPHICS  
 PG. 110

AUDIO  
 PG. 111

CUSTOM  
 PG. 112-113

FIT CHARTS  
 PG. 190-203



# PROTECTION

**PROTECT YOUR INVESTMENT.** These rugged brushguards add a sporty look and excellent protection from brush, low-hanging branches and trail debris. Optimize the custom look and protection by putting both front and rear brushguards on your *RANGER RZR*.



^ DELUXE REAR BRUSHGUARD

DELUXE FRONT > BRUSHGUARD

A



^ PRE-RUNNER REAR BRUSHGUARD

PRE-RUNNER FRONT > BRUSHGUARD

B

## A. DELUXE BRUSHGUARD

- Provides extensive front and rear protection
- Durable, corrosion-resistant steel construction
- Installs in less than 10 minutes using pre-drilled mount locations
- Integrates with Winch and Plow Systems

### DELUXE FRONT BRUSHGUARD

PART NO. 2876520-458

FITMENT RANGER RZR MY 08-10, RANGER RZR S MY 09-10

### DELUXE REAR BRUSHGUARD

PART NO. 2876521-458

FITMENT RANGER RZR MY 08-10

CUSTOMIZE THIS BRUSHGUARD WITH LIGHTING ACCESSORIES PG. 109



^ DELUXE BRUSHGUARD WITH PIAA 35 WATT LIGHTS

## B. PRE-RUNNER BRUSHGUARD

- Adds a sporty look and excellent front and rear protection
- Durable 4 cm tube design, with a powder-coat finish
- Installs in less than 10 minutes using pre-drilled mount locations
- Integrates with Winch and Plow Systems

### PRE-RUNNER FRONT BRUSHGUARD

PART NO. 2876400-458

FITMENT RANGER RZR MY 08-10, RANGER RZR S MY 09-10

### PRE-RUNNER REAR BRUSHGUARD

PART NO. 2877468-458

FITMENT RANGER RZR MY 08-10

CUSTOMIZE THIS BRUSHGUARD WITH LIGHTING ACCESSORIES PG. 109



^ PRE-RUNNER BRUSHGUARD WITH PIAA 35 WATT LIGHTS



2010 RANGER RZR

CAB SELECTOR NEW PG. 78 - 79

CABS NEW PG. 80 - 87

ROOFS & WINDSHIELDS PG. 88 - 89

PROTECTION PG. 90 - 95

PLOWS & WINCHES PG. 96 - 97

STORAGE PG. 98 - 101

PERFORMANCE PG. 102 - 103

RIMS & TIRES PG. 104 - 107

TRACKS PG. 108

LIGHTING PG. 109

GRAPHICS PG. 110

AUDIO PG. 111

CUSTOM PG. 112 - 113

FIT CHARTS PG. 190 - 203

# PROTECTION



ALUMINUM REAR BRUSHGUARD

ALUMINUM FRONT BRUSHGUARD

A

## A. ALUMINUM BRUSHGUARD

- Provides extensive front and rear protection
- Made with premium lightweight aluminum 4 cm tube with a brushed finish
- Installs in less than 10 minutes using pre-drilled mount locations
- Integrates with Winch and Plow Systems

### ALUMINUM FRONT BRUSHGUARD

PART NO. 2877308

FITMENT RANGER RZR MY 08-10, RANGER RZR S MY 09-10

### ALUMINUM REAR BRUSHGUARD

PART NO. 2877309

FITMENT RANGER RZR MY 08-10, RANGER RZR S MY 09-10

CUSTOMIZE THIS BRUSHGUARD WITH LIGHTING ACCESSORIES PG. 109



ALUMINUM BRUSHGUARD WITH PIAA 35 WATT LIGHTS



ALUMINUM ROCK SLIDER

B



ROCK SLIDER

C



NERF BAR

D

## B. ALUMINUM ROCK SLIDERS

- Protects vehicle sides and bottom
- Lightweight, durable aluminum, brushed finish
- Easy installation using pre-drilled holes

PART NO. 2877389

FITMENT RANGER RZR MY 08-10, RANGER RZR S MY 09-10

## C. ROCK SLIDERS

- Protects side and bottom of vehicle from rocks
- Adds a custom, low-profile look
- Rust-resistant powder-coat finish
- Easy installation using pre-drilled holes

PART NO. 2876522-458

FITMENT RANGER RZR MY 08-10, RANGER RZR S MY 09-10

## D. NERF BARS

- Adds side and bottom protection from trail obstacles
- Rust-resistant powder coat finish for a great look
- Easy installation

PART NO. 2876692-458

FITMENT RANGER RZR MY 08-10, RANGER RZR S MY 09-10

NEW 2010

POLARIS

2010 RANGER RZR

CAB SELECTOR NEW PG. 78 - 79

CABS NEW PG. 80 - 87

ROOFS & WINDSHIELDS PG. 88 - 89

PROTECTION PG. 90 - 95

PLOWS & WINCHES PG. 96 - 97

STORAGE PG. 98 - 101

PERFORMANCE PG. 102 - 103

RIMS & TIRES PG. 104 - 107

TRACKS PG. 108

LIGHTING PG. 109

GRAPHICS PG. 110

AUDIO PG. 111

CUSTOM PG. 112 - 113

FIT CHARTS PG. 190 - 203



# PROTECTION

## A. UNDERBODY SKID PLATE

- Aluminum components replace stock plastic skid plate
- Ideal for serious trail and desert riders
- Skid plate: 0.3 cm aluminum sides, front 2/3rd; 0.5 cm rear 1/3rd
- Includes all mounting hardware
- Replaces stock plastic skid plate

PART NO. 2876736

FITMENT RANGER RZR MY 08-10, RANGER RZR S MY 09-10

## B. RANGER RZR A-ARM GUARDS

- Protects A-arms and shafts
- Strong, lightweight 0.3 cm aluminum

### FRONT A-ARM GUARDS

PART NO. 2876734

FITMENT RANGER RZR MY 08-10

### REAR A-ARM GUARDS

PART NO. 2876735

FITMENT RANGER RZR MY 08-10

## C. RANGER RZR S A-ARM GUARDS

- Protects A-arms and shafts
- Strong, lightweight 0.3 cm aluminum

### FRONT A-ARM GUARDS

PART NO. 2877322

FITMENT RANGER RZR S MY 09-10

### REAR A-ARM GUARDS

PART NO. 2877323

FITMENT RANGER RZR S MY 09-10

## D. REAR DIFFERENTIAL SKID PLATE

- Strong, lightweight 0.3 cm aluminum
- Adds protection from boulders and stumps
- Ideal for serious trail and desert riders

PART NO. 2877026

FITMENT RANGER RZR MY 08

PART NO. 2877728

FITMENT RANGER RZR 09-10, RANGER RZR S 09-10

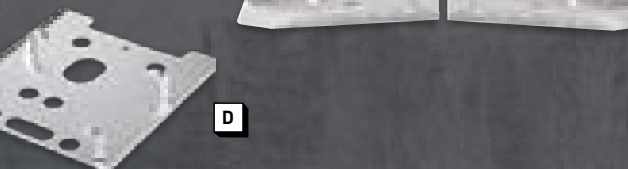
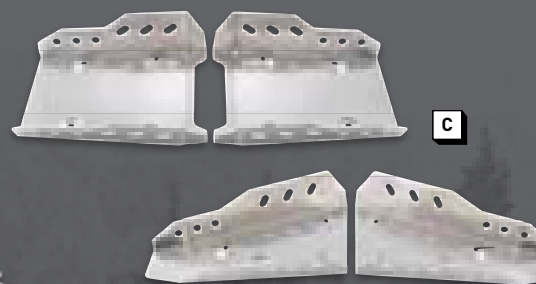
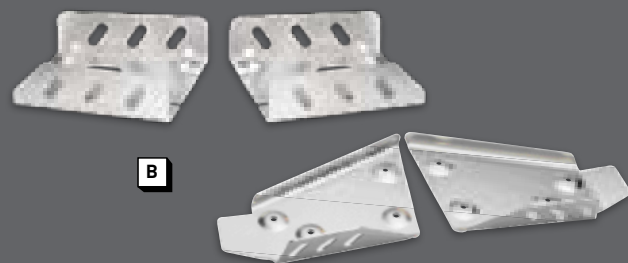

FENDER FLARE KIT (FRONT)



FENDER FLARE KIT (REAR)

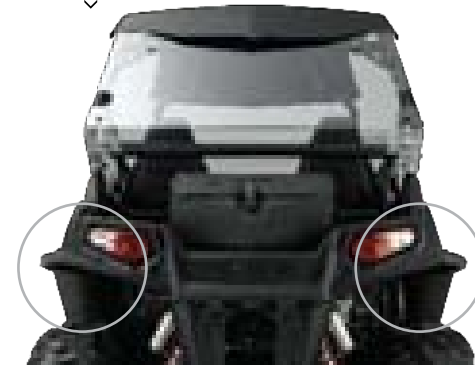

FENDER FLARE KIT (PROFILE)

## E. FENDER FLARE KIT

- Updates RANGER RZR to RANGER RZR S
- Adds side and mud protection
- Essential when upgrading rims and tire kits
- High-quality durable plastic, 10 cm wide
- Includes flares for all four fenders
- Includes front and rear fender flares, mounting hardware and instructions

PART NO. 2877314

FITMENT RANGER RZR MY 08-10

EXTREME FENDER PROTECTION KIT (FRONT)



EXTREME FENDER PROTECTION KIT (REAR)



EXTREME FENDER PROTECTION KIT (PROFILE)

## F. EXTREME FENDER PROTECTION KIT

- Protects plastic from trees and debris
- Rugged, 3.2 cm steel tubing
- Fits only with stock tires/wheels and 30 cm aluminum rims
- Does not fit with Fender Flare Kit

### FRONT EXTREME FENDER PROTECTORS

PART NO. 2876690-458

FITMENT RANGER RZR MY 08-10

### REAR EXTREME FENDER PROTECTORS

PART NO. 2876691-458

FITMENT RANGER RZR MY 08-10

**2010 RANGER RZR**

- CAB SELECTOR **NEW**  
PG. 78 - 79
- CABS **NEW**  
PG. 80 - 87
- ROOFS & WINDSHIELDS  
PG. 88 - 89
- PROTECTION**  
PG. 90 - 95
- PLOWS & WINCHES  
PG. 96 - 97
- STORAGE  
PG. 98 - 101
- PERFORMANCE  
PG. 102 - 103
- RIMS & TIRES  
PG. 104 - 107
- TRACKS  
PG. 108
- LIGHTING  
PG. 109
- GRAPHICS  
PG. 110
- AUDIO  
PG. 111
- CUSTOM  
PG. 112 - 113
- FIT CHARTS  
PG. 190 - 203

# GLACIER® II PLOW SYSTEM

**THE ULTIMATE.** This is the absolute best plow system for your RANGER RZR. First, because our engineers designed and tested every component, so you know it fits, it works and it will last. Second, because it uses our exclusive Lock & Ride® technology for the fastest on/off capability in the industry.



## ORDERING A POLARIS PLOW SYSTEM

### STEP 1

#### SELECT A MOUNT

Our mount plates are designed exclusively for RANGER RZR models, not a "generic fit" design like our competitors.

### STEP 2

#### SELECT A FRAME

Lock & Ride® - easy on/off

### STEP 3

#### SELECT A LIFT METHOD

Choose a Polaris winch or Polaris Warn® winch.

### STEP 4

#### SELECT A PLOW BLADE

Select a blade from our variety of sizes and capabilities. All blades fit all our plow frames.

## STEP 1 SELECT A MOUNT

### GLACIER II RZR PLOW MOUNT

- Integrates with all Polaris brushguards
- Easily installed with 6 bolts
- Includes plow blade markers, mounting hardware

PART NO. 2876450

FITMENT RANGER RZR MY 08-10, RANGER RZR S MY 09-10

### ! ATTENTION

Plow mount will fit with any Pure Polaris brushguard. Recommend using Coil Spring Spacers 2872655, sold in pairs.

## STEP 2 SELECT A FRAME

### GLACIER II RZR PLOW FRAME

PART NO. 2876623

FITMENT RANGER RZR MY 08-10, RANGER RZR S MY 09-10

## STEP 3 SELECT A LIFT METHOD

### RANGER RZR POLARIS 1,587 KG SEALED WINCH

PART NO. 2877349

FITMENT RANGER RZR MY 08-10, RANGER RZR S MY 09-10

### RANGER RZR WARN® 3.0 RT WINCH

PART NO. 2876446

FITMENT RANGER RZR MY 08-10, RANGER RZR S MY 09-10

## STEP 4 SELECT A PLOW BLADE

### 132 cm SNOW BLADE

PART NO. 2876627

FITMENT RANGER RZR MY 08-10

### 152 cm SNOW BLADE

PART NO. 2876626

FITMENT RANGER RZR MY 08-10, RANGER RZR S MY 09-10

### 152 cm RAZOR TWO-WAY BLADE

PART NO. 2875370

FITMENT RANGER RZR MY 08-10, RANGER RZR S MY 09-10

### GLACIER II PLOW SYSTEM



# WINCHES

**MORE PULL.** A RANGER RZR gives you razor-sharp performance. Add a Pure Polaris winch and it also gives you heavy-duty pulling power for clearing trails, hauling out docks, pulling your whitetail out of a ravine, navigating difficult terrain, plowing, self-rescue and much more. Our winches are designed and tested by Polaris engineers specifically for the Polaris RANGER RZR, so you know they'll fit perfectly and give you years of rugged pulling power.



## A. RANGER RZR POLARIS 1,587 KG. SEALED WINCH

- Most powerful winch available for RANGER RZR
- 15.2 m of 0.5 cm synthetic rope, with a 1,587 kg.-rated pull
- Rugged 1.2 hp motor, sealed for extreme conditions
- Includes handheld remote, roller fairlead, hook, strap
- Integrates with all Polaris brushguard systems

PART NO. 2877349

FITMENT RANGER RZR MY 08-10, RANGER RZR S MY 09-10

## B. RANGER RZR WARN® 3.0 RT WINCH

- Features Polaris exclusive mount plate
- Delivers an incredible 617 kg-rated pull
- Convenient handheld remote
- Includes roller fairlead, hook and strap
- Integrates with all Polaris brushguard systems

PART NO. 2876446

FITMENT RANGER RZR MY 08-10, RANGER RZR S MY 09-10

## C. SHIFT KNOB WINCH CONTROLLER

- Great for plowing
- Replaces the stock shift knob
- Integrates winch switch into the shift knob
- Can be used with any Pure Polaris or Warn winch

PART NO. 2877874

FITMENT RANGER RZR MY 08-10, RANGER RZR S MY 09-10

CAB SELECTOR NEW  
PG. 78 - 79

CABS NEW  
PG. 80 - 87

ROOFS & WINDSHIELDS  
PG. 88 - 89

PROTECTION  
PG. 90 - 95

PLOWS & WINCHES  
PG. 96 - 97

STORAGE  
PG. 98 - 101

PERFORMANCE  
PG. 102 - 103

RIMS & TIRES  
PG. 104 - 107

TRACKS  
PG. 108

LIGHTING  
PG. 109

GRAPHICS  
PG. 110

AUDIO  
PG. 111

CUSTOM  
PG. 112 - 113

FIT CHARTS  
PG. 190 - 203



# STORAGE

>>>

**TAKE IT ALL WITH YOU.** Bags, boxes, bars, nets - it's all here - everything you need to store and protect your gear, tools, spare tire, fuel and firearms. These Pure Polaris accessories are designed to help you make the most of every outing, add incredible versatility and keep your **RANGER RZR** looking razor-sharp.



**NEW 2010**

## A. LOCK & RIDE® BOX COVER

- Completely encloses the rear box
- Tight seal around entire perimeter
- Protects gear from dust and weather
- 2.1 cu. m capacity, with latching cover
- Holds two helmets and gear
- Integrates with all cabs (except canvas)

PART NO. 2877959

FITMENT RANGER RZR MY 08-10, RANGER RZR S MY 09-10



LOCK & RIDE BOX COVER ON RANGER RZR S

## B. LOCK & RIDE® CARGO BOX

- Protects your gear while riding
- Attaches to bed in 10 seconds
- Rubber gasket keeps out dirt and water
- Lockable latches, heavy-duty hinges, side handles

PART NO. 2876439-070

FITMENT RANGER RZR MY 08-10, RANGER RZR S MY 09-10



## C. LOCK & RIDE® BED EXTENDER

- Boosts cargo carrying ability
- Adds 15 cm to height of box
- Installs in seconds
- Integrates with many other accessories

PART NO. 2877316-458

FITMENT RANGER RZR MY 08-10

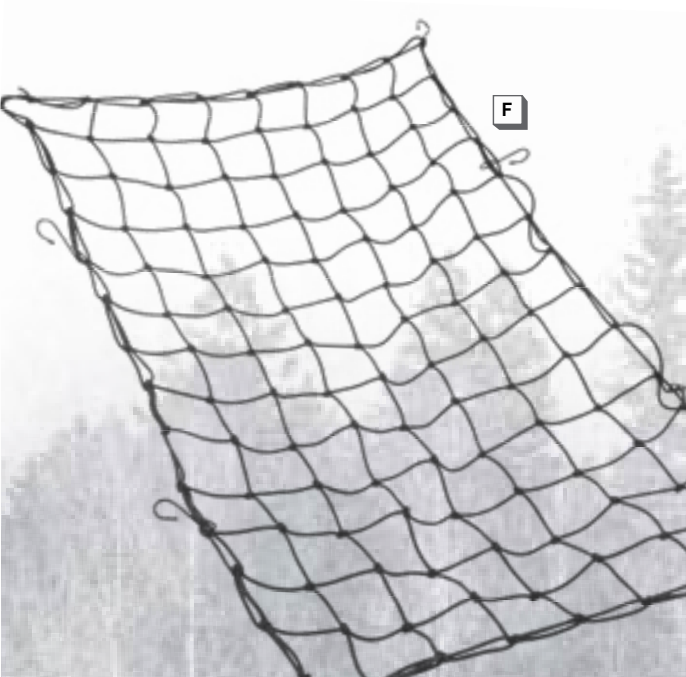
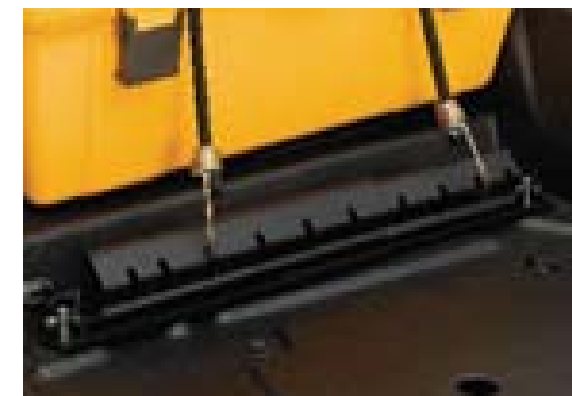

## D. LOCK & RIDE® FUEL CAN MOUNT

- Secures fuel can to cargo bed
- Holds most 9.5 L fuel cans
- Attaches and detaches in seconds
- Works with all box accessories
- Fuel can not included

PART NO. 2876379-458

FITMENT RANGER RZR MY 08-10, RANGER RZR S MY 09-10

## E. LOCK & RIDE® TIE DOWN BAR

- Adds multiple tie-down points inside box
- Fits into various Lock & Ride® holes
- Helps secure cargo in one half of the box
- Bungee straps not included

PART NO. 2876417-458

FITMENT RANGER RZR MY 08-10, RANGER RZR S MY 09-10

## F. BOX NET

- Stretches over cargo, attaches with multiple hooks
- Secures cargo in RANGER RZR box

PART NO. 2876702

FITMENT RANGER RZR MY 08-10, RANGER RZR S MY 09-10

## G. BED D-RING

- Creates additional tie-down points in box
- Makes securing cargo quick and easy
- Kit includes 4 D-rings and hardware

PART NO. 2877460

FITMENT RANGER RZR MY 08-10

## H. LOCK & RIDE FLAG MOUNT

- Expansion anchor allows easy on/off
- Holds whip flag, required in some areas

PART NO. 2877502

FITMENT RANGER RZR MY 08-10, RANGER RZR S MY 09-10

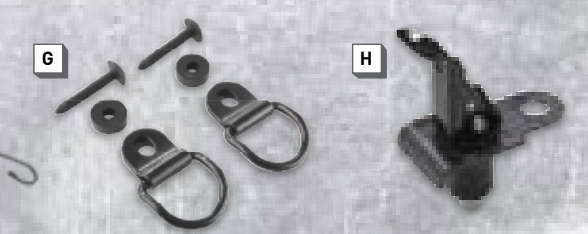

PURE  
2010 RANGER RZR

CAB SELECTOR NEW  
PG. 78 - 79

CABS NEW  
PG. 80 - 87

ROOFS & WINDSHIELDS  
PG. 88 - 89

PROTECTION  
PG. 90 - 95

PLOWS & WINCHES  
PG. 96 - 97

STORAGE  
PG. 98 - 101

PERFORMANCE  
PG. 102 - 103

RIMS & TIRES  
PG. 104 - 107

TRACKS  
PG. 108

LIGHTING  
PG. 109

GRAPHICS  
PG. 110

AUDIO  
PG. 111

CUSTOM  
PG. 112 - 113

FIT CHARTS  
PG. 190 - 203



# STORAGE



A

## A. SPARE TIRE HOLDER

- Mounts spare tire outside cargo box
- Keeps box open for other cargo
- Lets you always have a spare on hand

### RANGER RZR SPARE TIRE BAR

PART NO. 2876402-458

FITMENT RANGER RZR MY 08-10

### RANGER RZR SPARE TIRE HOLDER

PART NO. 2877358

FITMENT RANGER RZR MY 08-10

## ! ATTENTION

Required for RANGER RZR fitment: RANGER RZR Spare Tire Holder 2877358, Rear Bumper 2876403-458 or 2877309, Lock & Ride® Accessory Rack 2876378-458, and Spare Tire Bar 2876402-458. Only use front tire for spare.



B

## B. RANGER RZR S SPARE TIRE HOLDER

PART NO. 2877319-458

FITMENT RANGER RZR S MY 09-10

## C. LOCK & RIDE® ACCESSORY RACK

- Serves as platform for many other accessories
- Lock & Ride technology for quick attachment
- Works with Lock & Ride® Cargo Box, Bed Extender, Spare Tire Holder, Gun Scabbard, Box Net, Tie Down Bar, Fuel Can Mount, All Cabs

PART NO. 2876378-458

FITMENT RANGER RZR MY 08-10



C

## D. RANGER RZR S GUN SCABBARD MOUNT

- Raised above box to maximize carrying ability
- Gun boots sold separately

PART NO. 2877320-458

FITMENT RANGER RZR S MY 09-10



D

## E. RANGER RZR GUN SCABBARD MOUNT

- Same features as RANGER RZR S gun scabbard mount
- RANGER RZR requires Lock & Ride Accessory Rack

PART NO. 2876401-458

FITMENT RANGER RZR MY 08-10



E

## F. GUN BOOTS

- Securely protects and holds firearm
- Works with shotgun or rifle
- Padded interior, dust-proof, water-resistant

### MOSSY OAK® BREAK-UP® GUN BOOT

PART NO. 2872677-419

FITMENT RANGER RZR MY 08-10, RANGER RZR S MY 09-10

### BLACK GUN BOOT

PART NO. 2872677

FITMENT RANGER RZR MY 08-10, RANGER RZR S MY 09-10



F

## E. LOCKABLE GLOVE BOX

- Fits under right-side dash, approximately 14,750 cu. cm volume
- Lockable, with sealed door opening: 18 cm x 8 cm

PART NO. 2877310

FITMENT RANGER RZR MY 08-10, RANGER RZR S MY 09-10



E

## F. SHOULDER STORAGE BAG

- Fits between seats, attaches with clips
- Interior mesh pockets store small items

PART NO. 2877665

FITMENT RANGER RZR MY 08-10, RANGER RZR S MY 09-10



F

## G. UNDER DASH PASSENGER BAG

- Stores and protects personal items
- Mounts under right-side dash with Velcro®

PART NO. 2876707

FITMENT RANGER RZR MY 08-10, RANGER RZR S MY 09-10

## H. OVERHEAD MAP BAG

- Storage bag for maps, GPS, other small items
- Attaches to cab frame with Velcro® straps

PART NO. 2877664

FITMENT RANGER RZR MY 08-10, RANGER RZR S MY 09-10



G

## I. TRAILERING COVER

- Made of UV stable material to protect from fading
- Ratchet strap system on the bottom to secure the cover
- Designed with pockets to work with all bumper systems, roofs and box accessories excluding the spare tire holder and gun scabbard
- Forward trailering only

### RANGER RZR COVER

PART NO. 2876526

FITMENT RANGER RZR MY 08-10

### RANGER RZR S COVER

PART NO. 2877321

FITMENT RANGER RZR S MY 09-10



I



H



# PERFORMANCE

**DIAL IT UP.** Take your *RANGER RZR* or *RANGER RZR S* to the next level with performance accessories from Pure Polaris. Want to transform your *RANGER RZR* suspension into the long-travel design of the *RANGER RZR S*? There's a kit for that. Kick up the power? We've got performance exhaust systems. Protect your shocks? Grab some front and rear shock covers.

**NEW 2010**

## A. LONG TRAVEL KIT

- Transforms your *RANGER RZR* into a *RANGER RZR S*
- Adds extra suspension travel for sport riding
- Includes upper/lower control arms, half-shafts, rear torsion bar, front steering rack, brake lines, all hardware
- Dealer install only, Polaris recommends use only with 30 cm rims

PART No. 2877312  
FITMENT *RANGER RZR MY 09-10*

## B. WALKER EVANS™ SHOCKS

- Features 5 cm bore, full preload, 16 quick adjustment for compression tuning
- Anti-fade oil developed from years of desert racing
- Heat-treated stainless steel shocks
- Billet anodized aluminum reservoir
- Shocks sold separately, springs included

**NEW 2010**

### FRONT SHOCKS

PART No. 2876898  
FITMENT *RANGER RZR MY 08-10*

PART No. 2877835  
FITMENT *RANGER RZR S MY 09-10*

### REAR SHOCKS

PART No. 2876899  
FITMENT *RANGER RZR MY 08-10*

PART No. 2877789  
FITMENT *RANGER RZR S MY 09-10*

## C. FOX PODIUM® X SHOCKS

- Piggyback reservoir
- Preload and compression adjustable
- Set of 4 per kit, fully assembled with springs
- Ready to bolt on

**NEW 2010**

PART No. 2877313  
FITMENT *RANGER RZR MY 09-10 with Long Travel Kit*

## D. SHOCK COVERS

- Adds shock protection, for stock shocks only

### FRONT SHOCK COVERS

PART No. 2876848  
FITMENT *RANGER RZR MY 08-10*

### REAR SHOCK COVERS

PART No. 2876849  
FITMENT *RANGER RZR MY 08-10*



### PERFORMANCE CUSTOMIZED >



Give your *RANGER RZR* the same high-performance suspension as a *RANGER RZR S* with our Long Travel Kit and Fox Podium® X Shocks.



Our new high-performance Walker Evans Shocks let you upgrade the suspension on your *RANGER RZR S*.

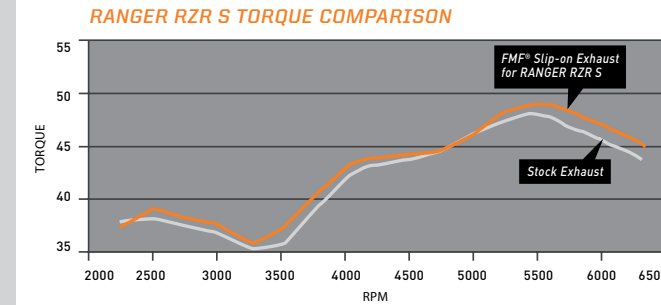

## E. RANGER RZR S FMF® SLIP-ON EXHAUST

**NEW 2010**

- Engineered by FMF® for maximum torque and horsepower
- High-strength stainless steel
- Use with stock header and mid-pipe
- Includes USFS certified spark arrestor

PART No. 2877617  
FITMENT *RANGER RZR S 09-10*

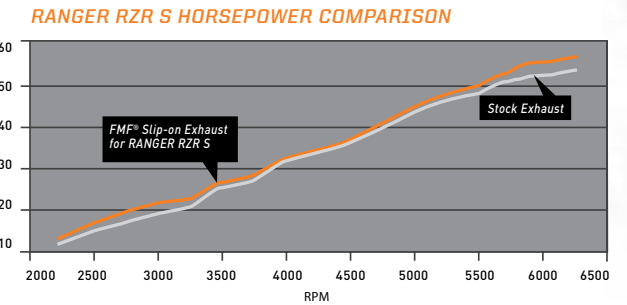

### ! ATTENTION

Installation of these exhausts may increase sound levels to exceed state sound level limits

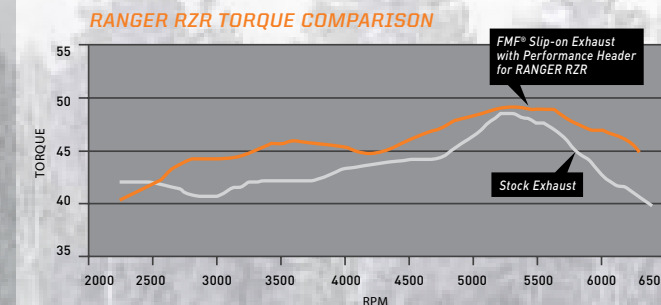

## F. RANGER RZR SLIP-ON EXHAUST

- Optimal power and exhaust note with minimal sound increase
- Made of high-strength stainless steel
- Uses stock heat shield for maximum reliability
- Includes USFS certified spark arrestor

PART No. 2876850  
FITMENT *RANGER RZR 08-10*

## G. RANGER RZR PERFORMANCE HEADER

- Adds performance and style
- Fits with *RANGER RZR* FMF® Slip-On #2876850
- Total system adds 5% hp increase and torque across powerband

PART No. 2877318  
FITMENT *RANGER RZR 08-10*

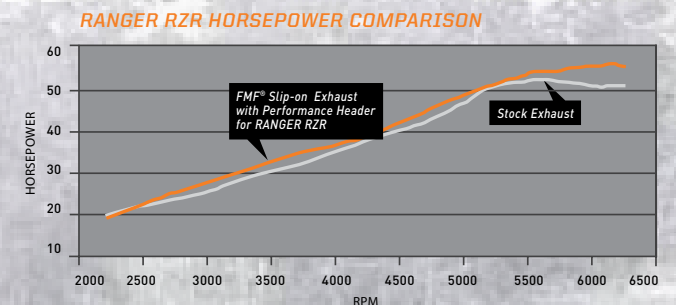

- CAB SELECTOR NEW PG. 78 - 79
- CABS NEW PG. 80 - 87
- ROOFS & WINDSHIELDS PG. 88 - 89
- PROTECTION PG. 90 - 95
- PLOWS & WINCHES PG. 96 - 97
- STORAGE PG. 98 - 101
- PERFORMANCE PG. 102 - 103
- RIMS & TIRES PG. 104 - 107
- TRACKS PG. 108
- LIGHTING PG. 109
- GRAPHICS PG. 110
- AUDIO PG. 111
- CUSTOM PG. 112 - 113
- FIT CHARTS PG. 190 - 203



# RIMS & TIRES

**TREAD READY.** How much traction you need depends on how and where you ride. That's why Pure Polaris offers such a wide variety of tires, including the all-new 36 cm machined and flat black SIXr Rims and 66 cm Maxxis® Bighorn™ Tires. And when it comes to rims, you can choose from a huge selection, many available in black or silver. Buy just the rims or go with the complete tire/rim package. Either way, you know you're riding on high-quality products from Pure Polaris.



### A. 36 CM SIXr RIMS WITH 66 CM MAXXIS® BIGHORN® TIRES

- Our newest custom rims feature a dual 6-spoke design
- Radial construction creates a smooth ride on dirt, rocks and desert
- Features extra lugs on shoulder to protect sidewall and rim
- Raised lettering on one side
- Lug nuts sold separately

### 36 CM FLAT BLACK SIXr RIMS WITH 66 CM MAXXIS® BIGHORN® TIRES

PART NO. 2878030  
 QUANTITY Set of 4  
 RIM SPEC 36 cm x 18 cm (Front); 36 cm x 20 cm (Rear)  
 TIRE SPEC 66 cm x 23 cm x 36 cm (Front); 66 cm x 28 cm x 36 cm (Rear)  
 FITMENT RANGER RZR MY 08-10

### 36 CM MACHINED SIXr RIMS WITH 66 CM MAXXIS® BIGHORN® TIRES

PART NO. 2878032  
 QUANTITY Set of 4  
 RIM SPEC 36 cm x 18 cm (Front); 36 cm x 20 cm (Rear)  
 TIRE SPEC 66 cm x 23 cm x 36 cm (Front); 66 cm x 28 cm x 36 cm (Rear)  
 FITMENT RANGER RZR MY 08-10



### B. 36 CM CRUSHER RIMS WITH MAXXIS® BIGHORN® TIRES

- Custom 8-spoke Crusher Rim design is Polaris exclusive
- Radial construction creates a smooth ride on dirt, rocks and desert
- Features extra lugs on shoulder to protect sidewall and rim
- Raised lettering on one side
- Lug nuts sold separately

### 36 CM BLACK CRUSHER RIMS WITH 66 CM MAXXIS® BIGHORN® TIRES

PART NO. 2877159  
 QUANTITY Set of 4  
 RIM SPEC 36 cm x 18 cm (Front); 36 cm x 20 cm (Rear)  
 TIRE SPEC 66 cm x 23 cm x 36 cm (Front); 66 cm x 28 cm x 36 cm (Rear)  
 FITMENT RANGER RZR MY 08-10



### 36 CM SILVER CRUSHER RIMS WITH 66 CM MAXXIS® BIGHORN® TIRES

PART NO. 2876907  
 QUANTITY Set of 4  
 RIM SPEC 36 cm x 18 cm (Front); 36 cm x 20 cm (Rear)  
 TIRE SPEC 66 cm x 23 cm x 36 cm (Front); 66 cm x 28 cm x 36 cm (Rear)  
 FITMENT RANGER RZR MY 08-10



### C. 36 CM BUCKSHOT RIMS WITH VISION TRAILFINDER™ TIRES

- Unique, automotive-inspired, 8-spoke Buckshot design
- Tread pattern delivers excellent mud, trail and off-road performance
- Lug nuts sold separately

PART NO. 2877605  
 QUANTITY Set of 4  
 RIM SPEC 36 cm x 18 cm (Front); 36 cm x 20 cm (Rear)  
 TIRE SPEC 15 cm x 25 cm x 36 cm (Front); 66 cm x 31 cm x 36 cm (Rear)  
 FITMENT RANGER RZR MY 08-10



### D. 36 CM BRUISER RIMS WITH MAXXIS® BIGHORN® TIRES

- Beefy, 4-spoke Bruiser Rim design is a Polaris exclusive
- Radial construction creates a smooth ride on dirt, rocks and desert
- Features extra lugs on shoulder to protect sidewall and rim
- Raised lettering on one side
- Lug nuts sold separately

PART NO. 2876944  
 QUANTITY Set of 4  
 RIM SPEC 36 cm x 18 cm (Front); 36 cm x 20 cm (Rear)  
 TIRE SPEC 66 cm x 23 cm x 36 cm (Front); 66 cm x 28 cm x 36 cm (Rear)  
 FITMENT RANGER RZR MY 08-10



### BRUISER & CRUSHER CENTER CAP

PART NO. 2854604



### CHROME SIXr CENTER CAP

PART NO. 1521509-410

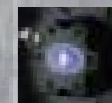

### FLAT BLACK SIXr CENTER CAP

PART NO. 1521509-521



### SAE LUG NUTS FOR ALUMINUM RIMS

PART NO. 2876754

QUANTITY Set of 4

PART NO. 2877409

QUANTITY Set of 16

- CAB SELECTOR NEW PG. 78 - 79
- CABS NEW PG. 80 - 87
- ROOFS & WINDSHIELDS PG. 88 - 89
- PROTECTION PG. 90 - 95
- PLOWS & WINCHES PG. 96 - 97
- STORAGE PG. 98 - 101
- PERFORMANCE PG. 102 - 103
- RIMS & TIRES PG. 104 - 107**
- TRACKS PG. 108
- LIGHTING PG. 109
- GRAPHICS PG. 110
- AUDIO PG. 111
- CUSTOM PG. 112 - 113
- FIT CHARTS PG. 190 - 203



# RIMS & TIRES

## A. 36 CM SIXr RIMS

- Our newest custom rim features a dual 6-spoke design
- Choose flat black or machined

**NEW**  
2010

## 36 CM FLAT BLACK SIXr RIMS

PART NO. 1521507-521

SPEC Front 36 cm x 18 cm

PART NO. 1521508-521

SPEC Rear 36 cm x 20 cm

FITMENT RANGER RZR MY 08-10

## 36 CM MACHINED SIXr RIMS

PART NO. 1521507-266

SPEC Front 36 cm x 18 cm

PART NO. 1521508-266

SPEC Rear 36 cm x 20 cm

FITMENT RANGER RZR MY 08-10

## B. 36 CM CRUSHER RIMS

- Custom 8-spoke Crusher Rim design is a Polaris exclusive
- Cast aluminum for strength and light weight

## 36 CM BLACK CRUSHER RIMS

PART NO. 2877157

SPEC Front 36 cm x 18 cm

PART NO. 2877158

SPEC Rear 36 cm x 20 cm

FITMENT RANGER RZR MY 08-10

## 36 CM SILVER CRUSHER RIMS

PART NO. 2876281

SPEC Front 36 cm x 18 cm

PART NO. 2876282

SPEC Rear 36 cm x 20 cm

FITMENT RANGER RZR MY 08-10

## C. 36 CM - 30.5 CM BRUISER RIMS

- Beefy, 4-spoke Bruiser Rim design is a Polaris exclusive
- Cast aluminum for strength and light weight

## 36 CM BRUISER RIMS

PART NO. 2875904

SPEC Front 36 cm x 18 cm

PART NO. 2875905

SPEC Rear 36 cm x 20 cm

FITMENT RANGER RZR MY 08-10

## 30.5 CM BRUISER RIMS

PART NO. 2875902

SPEC Front 30.5 cm x 18 cm

PART NO. 2875903

SPEC Rear 30.5 cm x 20 cm

FITMENT RANGER RZR MY 08-10



## D. 30.5 CM CAST ALUMINUM RIMS

- Classic 8-spoke design, a Polaris exclusive
- Cast aluminum for strength and light weight
- Machined center cap within the wheel

PART NO. 2876086

SPEC Front 30.5 cm x 15 cm

PART NO. 2876087

SPEC Rear 30.5 cm x 20 cm

FITMENT RANGER RZR MY 08-10



## E. MAXXIS® BIGHORN® TIRES

- Radial construction creates a smooth ride on dirt, rocks and desert
- Features extra lugs on shoulder to protect sidewall and rim
- Raised lettering on one side

PART NO. 2876905

SPEC Front 66 cm x 23 cm x 36 cm

FITMENT 36 cm x 18 cm Front Wheel

PART NO. 2876906

SPEC Rear 66 cm x 28 cm x 36 cm

FITMENT 36 cm x 20 cm Rear Wheel

## F. 36 CM VISION TRAILFINDER® TIRES

- Tread pattern delivers a smooth ride on the trail
- Excellent mud and off-road performance

PART NO. 5413659

SPEC Front 66 cm x 25 cm x 36 cm

FITMENT 36 cm x 18 cm Front Wheel

PART NO. 5413660

SPEC Rear 66 cm x 31 cm x 36 cm

FITMENT 36 cm x 20 cm Rear Wheel

## G. 36 CM GOODYEAR® MTR TIRES

- Features an aggressive mud-tire tread pattern
- Delivers sharp steering response
- 6-ply rating

PART NO. 2875906

SPEC Front 64 cm x 20 cm x 31 cm

FITMENT 31 cm x 18 cm Front Wheel

PART NO. 2875907

SPEC Rear 64 cm x 25 cm x 31 cm

FITMENT 31 cm x 20 cm Rear Wheel

## H. CARLISLE™ ACT TIRES

- A great all-purpose, all-terrain tire
- Designed for both wet and dry conditions
- Sidewall design ensures a smooth ride

PART NO. 2876084

SPEC Front 58 cm x 18 cm x 31 cm

FITMENT 31 cm x 18 cm Front Wheel

PART NO. 2876085

SPEC Rear 58 cm x 25 cm x 31 cm

FITMENT 31 cm x 20 cm Rear Wheel

# TRACKS

>>>

**GO ANYWHERE.** The Prospector Pro-S is the most advanced track system ever built for Polaris vehicles. With its many rugged, uniquely engineered features, it truly is the ultimate all-season, all-terrain AWD track system for the RANGER RZR. It delivers excellent low-end performance in deep mud, swamps, bogs and snow. Holds traction better than its competition. Designed for an exact fit.

WWW.PUREPOLARIS.COM

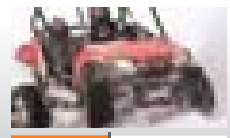

EXPERIENCE PROSPECTOR PRO TRACKS IN FULL MOTION VIDEO.

◀ ▶ ⏸

**STEP 1 SELECT A TRACK MOUNT**

**PROSPECTOR PRO TRACK MOUNTS**

- Outfits the RANGER RZR with the track system
- PART NO. 2876449
- FITMENT RANGER RZR MY 08-10

**STEP 2 SELECT A TRACK KIT**

**PROSPECTOR PRO-S TRACK KIT**

- Fine-tuned gear ratio to optimize track spin
  - Long rear footprint for superior flotation
- PART NO. 2877539
- FITMENT RANGER RZR MY 08-10

**PROSPECTOR PRO UPDATE KIT**

- Allows updating a Prospector Pro (2876664) to a Pro-S
  - Improved gear ratio and longer rear footprint
- PART NO. 2877540
- FITMENT All Prospector Pro Track Kits

Features large-diameter corner wheels to increase the approach angle and easily clear obstacles.



Spring loaded anti-rotation, incredible traction and flotation, longer wear and less maintenance.

OUTSIDE VIEW  
Prospector Pro Tracks

INSIDE VIEW  
Prospector Pro Tracks

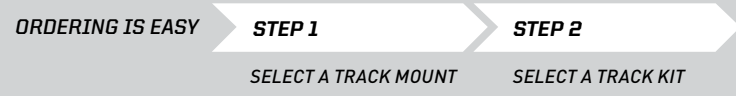

Optimized gearing for superior low-end performance and true AWD. Steering is easy, in mud, boggy terrain or snow, for longer rides with less fatigue.

# LIGHTING

>>>

**LIGHT 'EM UP.** Be seen and see better during all your rides in low-light and at night. We have rally lights and light bars, exclusive Pure Polaris accessories for your RANGER RZR. Mix and match to your exact needs.



**A. OFF-ROAD LIGHT BAR KIT**

- Nickel-plated housing, steel frame
- Blue LED ring and blue-tinted lenses
- 35 W halogen bulbs
- Wiring harness, rocker switch included

PART NO. 2877966

FITMENT RANGER RZR MY 08-10, RANGER RZR S MY 09-10

**STEP 1 SELECT A LIGHT BAR**

**B. LOCK & RIDE LIGHT BAR**

- Lock & Ride technology for easy on/off
- Includes 3 tabs for mounting lights

PART NO. 2876547-458

FITMENT RANGER RZR MY 08-10, RANGER RZR S MY 09-10

**STEP 2 SELECT WIRE HARNESS**

**LIGHT BAR WIRE HARNESS**

- Kit for Lock & Ride light bar
- Includes 3 connectors, auxiliary switch

PART NO. 2877336

FITMENT RANGER RZR MY 08-10, RANGER RZR S MY 09-10

**BRUSHGUARD WIRE HARNESS**

- Kit for Lock & Ride light bar
- Includes 2 connectors, auxiliary switch

PART NO. 2877399

FITMENT RANGER RZR MY 08-10, RANGER RZR S MY 09-10

**STEP 3 SELECT A LIGHTS**

**C. RALLY LIGHTS**

- 10 cm lens with a 35 W halogen bulb
- Choose black with grille or chrome
- Sold individually

**BLACK RALLY LIGHTS**

PART NO. 2877335

FITMENT RANGER RZR MY 08-10, RANGER RZR S MY 09-10

**CHROME RALLY LIGHTS\***

PART NO. 2876445

FITMENT RANGER RZR MY 08-10, RANGER RZR S MY 09-10

**D. PIAA 35 WATT LIGHT**

- 10 cm lens with 35 W halogen bulb
- Durable black housing, custom PIAA grille
- Sold individually

PART NO. 2876684

FITMENT RANGER RZR MY 08-10, RANGER RZR S MY 09-10

\* LIMITED QUANTITY



CAB SELECTOR NEW  
PG. 78 - 79

CABS NEW  
PG. 80 - 87

ROOFS & WINDSHIELDS  
PG. 88 - 89

PROTECTION  
PG. 90 - 95

PLOWS & WINCHES  
PG. 96 - 97

STORAGE  
PG. 98 - 101

PERFORMANCE  
PG. 102 - 103

RIMS & TIRES  
PG. 104 - 107

TRACKS  
PG. 108

LIGHTING  
PG. 109

GRAPHICS  
PG. 110

AUDIO  
PG. 111

CUSTOM  
PG. 112 - 113

FIT CHARTS  
PG. 190 - 203



## GRAPHICS

**MAKE IT YOUR OWN.** Customize your RANGER RZR with our flame decals, new painted replacement panels or blank panels that you can paint yourself.



### A. TRUE BLUE FLAME

- Includes hood, two rear side panels and access panel
- Pre-painted with custom blue flame design

PART NO. 2877968

FITMENT RANGER RZR 08-10, RANGER RZR S 09-10

### C. FLAME DECAL PACKAGE

- Front, rear and hood decals add a custom look
- Suitable on all colored units

PART NO. 2876698

FITMENT RANGER RZR MY 08-10, RANGER RZR S MY 09-10



### B. TRIBAL BLUE/SILVER

- Includes hood, two rear side panels and access panel
- Pre-painted with custom tribal blue and silver design

PART NO. 2877967

FITMENT RANGER RZR 08-10, RANGER RZR S 09-10

### D. PAINTABLE PLASTIC (TPO)

- Lets you do your own custom paint work
- Kit: rear fenders, hood, access panel, all decals

PART NO. 2203798

FITMENT RANGER RZR MY 08-10, RANGER RZR S MY 09-10



**NEW**  
2010

**NEW**  
2010

## AUDIO

**WOOFERS & TWEETERS.** Give your RANGER RZR a razor-edged sound system. Everything you need to bring your favorite tunes to the trail is on this page.



### E. KICK PANEL SPEAKER ENCLOSURES

- Designed to hold KICKER® speakers [2876179]
- Fits under dash

PART NO. 2876924

FITMENT RANGER RZR MY 08-10, RANGER RZR S MY 09-10

### F. OVERHEAD SPEAKER MOUNT CONSOLE

- Fits on top of the cage
- Speakers positioned toward both riders
- Works with any Polaris roof

PART NO. 2876443

FITMENT RANGER RZR 08-10, RANGER RZR S 09-10

### G. KICKER® SPEAKER

- Marine-grade, 17.8 cm outside diameter with a 13 cm cutout
- Titanium dome material
- Sold as pair

PART NO. 2876179 [Sold as pair]

FITMENT RANGER RZR MY 08-10, RANGER RZR S MY 09-10

### H. AUXILIARY BATTERY KIT

- Lets you add a second battery for electronics
- Includes isolator to separate batteries
- Switch for charging battery sold separately
- Mounts under driver seat
- Battery sold separately, use stock RZR battery #4011496

PART NO. 2876696

FITMENT RANGER RZR MY 08-10, RANGER RZR S MY 09-10

**NEW**  
2010



### I. KENWOOD™ AM/FM/CD STEREO

- Detachable face, compatible with iPod®
- PC marine-grade

PART NO. 2869510

FITMENT RANGER RZR MY 08-10, RANGER RZR S MY 09-10

### J. JENSEN™ AM/FM/CD/RADIO HEAD UNIT

- High-end Jensen® marine head unit
- 4x40w output, Sirius®-ready, skip protection
- Requires Radio Mount Kit

PART NO. 2876173-02

FITMENT RANGER RZR MY 08-10, RANGER RZR S MY 09-10

### K. RANGER RZR RADIO MOUNT KIT

- Mounting bracket, hardware for Jensen™ Unit

PART NO. 2876897

FITMENT RANGER RZR MY 08-10, RANGER RZR S MY 09-10

### L. IPOD™ CABLE

- Plugs into front of Jensen® Head Unit
- Works with #2876173-02

PART NO. 2876764

FITMENT RANGER RZR MY 08-10, RANGER RZR S MY 09-10

### M. AM/FM ANTENNA

PART NO. 2876183

FITMENT RANGER RZR MY 08-10, RANGER RZR S MY 09-10



CAB SELECTOR **NEW**  
PG. 78 - 79

CABS **NEW**  
PG. 80 - 87

ROOFS & WINDSHIELDS  
PG. 88 - 89

PROTECTION  
PG. 90 - 95

PLOWS & WINCHES  
PG. 96 - 97

STORAGE  
PG. 98 - 101

PERFORMANCE  
PG. 102 - 103

RIMS & TIRES  
PG. 104 - 107

TRACKS  
PG. 108

LIGHTING  
PG. 109

GRAPHICS  
PG. 110

AUDIO  
PG. 111

CUSTOM  
PG. 112 - 113

FIT CHARTS  
PG. 190 - 203

# CUSTOM

**ADD SOME BLING.** There are a lot of RANGER RZR vehicles out there. Make yours stand out with a custom seat cover, performance steering wheel and billet accessories.

## A. HOOD SCOOP

- Replaces stock access panel
- Three fully-screened intakes
- Enhances air flow to radiator to enhance cooling

PART NO. 2877876

FITMENT RANGER RZR 08-10, RANGER RZR S 09-10

**NEW**  
2010



A

## B. RANGER RZR SEAT COVER

- Slides over existing seat
- Adds a simulated carbon fiber look

PART NO. 2877324

FITMENT RANGER RZR MY 08-10, RANGER RZR S MY 09-10



B

C

## C. RANGER RZR CUSTOM SEAT

- Comfortable, soft-touch automotive vinyl
- Includes special sliding seat adjustment
- Mounts to stock seat base in minutes

PART NO. 2877306

FITMENT RANGER RZR MY 08-10, RANGER RZR S MY 09-10

## D. STOCK SEAT ADJUSTMENT KIT

- Attach to seat base with 4 bolts
- Allows seat to slide forward
- Sold individually

PART NO. 2877390

FITMENT RANGER RZR MY 08-10, RANGER RZR S MY 09-10



D

E

## E. PERFORMANCE STEERING WHEEL

- Adds a sporty look and a firm grip
- Requires Steering Wheel Adapter Hub

### PERFORMANCE STEERING WHEEL

PART NO. 2876164

FITMENT RANGER RZR MY 08-10, RANGER RZR S MY 09-10

### BILLET STEERING WHEEL ADAPTOR HUB

PART NO. 2876619

FITMENT RANGER RZR MY 08-10, RANGER RZR S MY 09-10

### BLACK STEERING WHEEL ADAPTOR HUB

PART NO. 2877419

FITMENT RANGER RZR MY 08-10, RANGER RZR S MY 09-10



F

## F. BILLET PASSENGER HANDLE

- Angled for passenger comfort
- Rubber grips with custom billet center

PART NO. 2877416

FITMENT RANGER RZR MY 08-10, RANGER RZR S MY 09-10

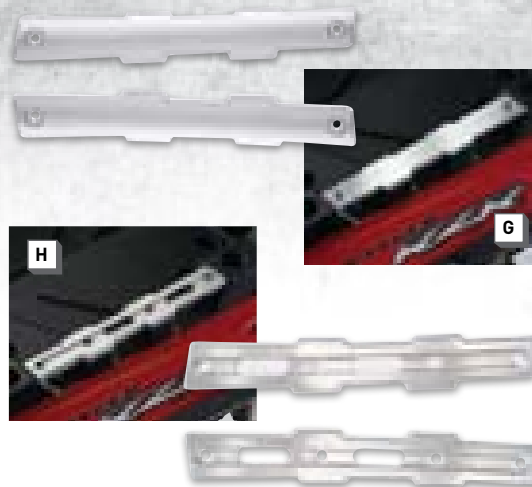

## G. POLISHED BILLET BOX RAILS

- Adds a custom look to top of box

PART NO. 2877307

FITMENT RANGER RZR MY 08-10, RANGER RZR S MY 09-10

## H. BILLET BOX RAILS

- Adds a custom look to top of box

PART NO. 2877413

FITMENT RANGER RZR MY 08-10, RANGER RZR S MY 09-10

## I. BILLET SPEEDO BEZEL

- Surrounds the speedo with custom bling

PART NO. 2877415

FITMENT RANGER RZR MY 08-10, RANGER RZR S MY 09-10



I

## J. BILLET BUMPER END CAPS

- Adds a custom touch to front or rear bumpers
- Fits Pre-Runner and Aluminum Brushguards

PART NO. 2877414

FITMENT RANGER RZR MY 08-10, RANGER RZR S MY 09-10



J

## K. BILLET GAS CAP

- Adds a nice custom touch to fuel tank

PART NO. 2876923

FITMENT RANGER RZR MY 08-10, RANGER RZR S MY 09-10



K

## L. BILLET SHIFTER

- Helps your RANGER RZR stand out
- Great custom look and feel

PART NO. 2876714

FITMENT RANGER RZR MY 08-10, RANGER RZR S MY 09-10



L



M

## M. STAINLESS STEEL POLARIS LETTERS

- Fits in the "Polaris" box imprint
- Applies with 3M adhesive tape

PART NO. 2877325

FITMENT RANGER RZR MY 08-10, RANGER RZR S MY 09-10



N

## N. BILLET FASTENERS

- Adds custom detail
- 10 per pack

PART NO. 2877672

FITMENT RANGER RZR MY 08-10, RANGER RZR S MY 09-10

**NEW**  
2010



WINCHES  
PG. 116 - 117

PLOWS  
PG. 118 - 123

TRACKS  
PG. 124 - 125

RIMS & TIRES  
PG. 126 - 129

WINDSHIELDS  
PG. 130 - 131

PROTECTION  
PG. 132 - 135

STORAGE  
PG. 136 - 144

MOWERS  
PG. 145

CUSTOM  
PG. 146 - 147

TRAILERING  
PG. 148 - 149

ENTRY  
PG. 150 - 151

FIT CHARTS  
PG. 190 - 203



**MAKE WORK EASIER.** Polaris ATVs are the hardest working and smoothest riding. And Pure Polaris accessories help you make them work or play harder. There are winches for pulling, brushguards for protection, blades for plowing – and hundreds of other items to add storage, go hunting, mow the lawn, give your ATV a custom look, and much more.



# WINCHES

**PULLING POWER.** A winch is the single most important accessory you can add to your ATV. Make it a rugged, high-quality Polaris winch. It will give you the confidence to tackle the toughest jobs and get out of the toughest situations with Pure pulling power.



## A. POLARIS 1,587 KG WINCH

- Rugged construction with 1,587 kg rated pull
- 15.2 m of 0.5 cm synthetic rope
- 1.2 hp motor, sealed for extreme conditions
- Includes handle bar switch and remote control, roller fairlead, hook, strap
- Integrates with all Polaris Brushguard systems.

PART NO. 2876591

FITMENT Sportsman XP 550/850 MY 09, Sportsman XP Touring & X2 550/850 MY 10

PART NO. 2877303

FITMENT Sportsman MY 05-10

PART NO. 2877820

FITMENT Sportsman XP 550 & 850 MY 10



## B. POLARIS 1,133 KG WINCH

- Delivers 1,133 kg rated pull
- 15.2 m of cable
- Sealed for resistance to extreme conditions
- Mechanical, dynamic brake, plus cam action for free-spooling
- Convenient handlebar switch, roller fairlead

PART NO. 2876592

FITMENT Sportsman XP 550/850 MY 09, Sportsman XP Touring & X2 550/850 MY 10

PART NO. 2877302

FITMENT Sportsman MY 05-10

PART NO. 2877819

FITMENT Sportsman XP 550/850 MY 10



## C. WARN® RT 30 WINCH

- Designed exclusively for the Polaris Sportsman
- Delivers an incredible 1,360-kg rated pull
- 13.7 m of cable
- Convenient handlebar switch
- Includes hook and red strap

PART NO. 2877455

FITMENT Sportsman XP 550/850 MY 09, Sportsman XP Touring & X2 550/850 MY 10

PART NO. 2876819

FITMENT Sportsman MY 05-10

PART NO. 2877821

FITMENT Sportsman XP 550/850 MY 10

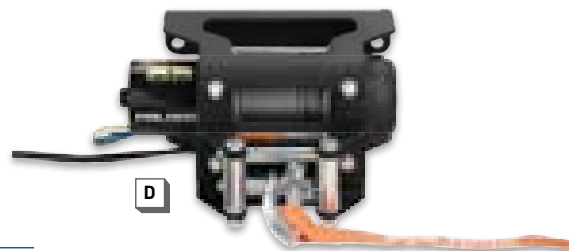

## D. POLARIS 680 KG WINCH

- A compact winch that fits our mid-size ATVs
- Hard-working 680-kg rated pull
- 15.2 m of cable
- Handlebar-mounted rocker switch
- Uses Hawse roller fairlead for smooth operation

PART NO. 2875880

FITMENT Sportsman 300, Hawkeye

PART NO. 2876639

FITMENT Sportsman 400 MY 09-10

PART NO. 2877976

FITMENT Scrambler, Trail Blazer MY 10



## E. POLARIS WIRELESS WINCH REMOTE

- Operates winch wirelessly within 15.2 m of ATV
- Plugs directly into Polaris Winch wire harness
- Red LED light indicates remote is transmitting
- Includes remote holster with belt clip

PART NO. 2877221

FITMENT Polaris or Polaris Warn ATV Winch Kits



## F. POLARIS WINCH ACCESSORY KIT

- Includes tow strap, shackle and snatch block
- Carrying bag keeps it all together

PART NO. 2876105

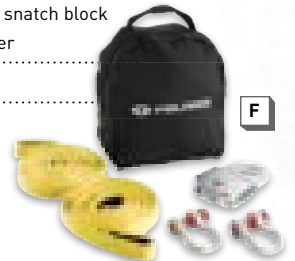

## G. ROPE

- Samson® 12-strand braided rope
- Maximum strength-to-weight ratio
- Stronger than wire rope, and it floats
- Superior flex and wear resistance

### ROPE WITHOUT LOOP

PART NO. 2875791

### ROPE WITH LOOP

PART NO. 2876499

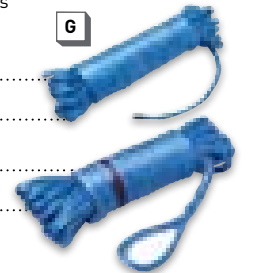

## H. SPORTSMAN XP WINCH WIRE KIT

- Allows installation of MY 09 XP winch on MY 10 550/850 XP

PART NO. 2878013

FITMENT Sportsman XP 550/850 MY 10

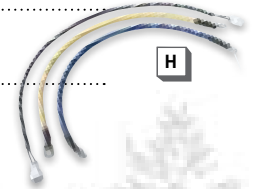

## WHAT WINCH IS RIGHT FOR ME? >

### POLARIS 1,587 KG WINCH

Our best value. Built for people who use their winch under extreme conditions and need the ultimate in pulling power.

### POLARIS 1,133 KG WINCH

A powerful, all-purpose winch, sealed for resistance to extreme conditions, with a 2500 lb.-rated pull.

### WARN® RT 30 WINCH

With an impressive 3,000-lb. rated pull, this winch delivers serious pulling power. Built by Warn® for Polaris.

### POLARIS 680 KG WINCH

This compact design is perfect for the Polaris mid-level and entry ATVs, with plenty of power to get the job done.

WINCHES  
PG. 116 - 117

PLOWS  
PG. 118 - 123

TRACKS  
PG. 124 - 125

RIMS & TIRES  
PG. 126 - 129

WINDSHIELDS  
PG. 130 - 131

PROTECTION  
PG. 132 - 135

STORAGE  
PG. 136 - 144

MOWERS  
PG. 145

CUSTOM  
PG. 146 - 147

TRAILERING  
PG. 148 - 149

ENTRY  
PG. 150 - 151

FIT CHARTS  
PG. 190 - 203



# PLOWS

**NOTHING ELSE COMES CLOSE.** You won't find a better plow anywhere. Pure Polaris Plow Systems give you the ultimate combination of quality, engineering, fit and quick attach features for your Polaris ATV. Our exclusive Lock & Ride® Glacier I and Glacier II Plows install in 45 seconds or less without tools (after the initial install of the mount). Choose from a wide variety of plow systems to match your needs and budget. Just follow the step-by-step process shown below, or ask your Polaris dealer for assistance.



## PUSH THROUGH. SELECT A PLOW SYSTEM >

FEATURES	GLACIER II PLOW SYSTEM	GLACIER I PLOW SYSTEM	EASY LIFT PLOW SYSTEM
LOCK & RIDE TECHNOLOGY	Yes	Yes	No
INITIAL INSTALL TIME	Less than 30 minutes	Less than 30 minutes	Approximately 1 hour
ATTACHMENT TIME	15 seconds or less	15 seconds or less	2-3 minutes
BLADE LIFT HEIGHT	51 cm +	33 cm+	25 cm+
BLADE ANGLE ADJUSTMENT	35°	35°	35°
FRAME LENGTH	56 cm+	102 cm+	102 cm+

### ORDERING A POLARIS PLOW SYSTEM

#### STEP 1

**SELECT A MOUNT**  
Our mount plates are designed exclusively for Sportsman models, not a "generic fit" design like our competitors.

#### STEP 2

**SELECT A FRAME**  
Lock & Ride® - easy on/off

#### STEP 3

**SELECT A LIFT METHOD**  
Choose a Polaris winch or Polaris Warn® winch.

#### STEP 4

**SELECT A PLOW BLADE**  
Select a blade from our variety of sizes and capabilities. All blades fit all our plow frames.

#### ADDITIONAL BLADE OPTIONS



152 CM, 132 CM, 122 CM SNOW BLADES



152 CM RAZOR TWO-WAY BLADE



122 CM ONE-WAY BLADE



STEP 4  
SELECT A MOUNT



STEP 2  
SELECT A FRAME



STEP 3  
SELECT A LIFT METHOD

STEP 1 >  
SELECT A MOUNT

[WWW.PUREPOLARIS.COM](http://WWW.PUREPOLARIS.COM)



EXPERIENCE GLACIER® PLOW SYSTEMS IN FULL MOTION VIDEO.



### BLADE WIDTH MATTERS >

When plowing, you want your tires to stay on the cleared path. Angling a 132 cm plow blade clears a path that's narrower than the width of a Polaris Sportsman. You'll be driving over snow yet to be plowed. For best snow plowing results, Polaris recommends a 152 cm plow for the Polaris Sportsman.

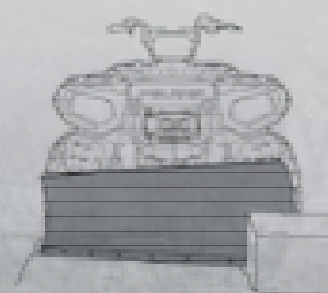

132 cm plow blade clears path less than the width a Polaris Sportsman

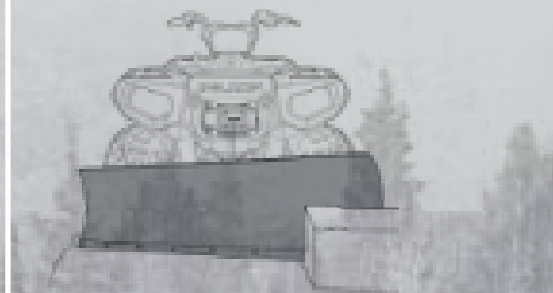

152 cm plow blade clears path greater than the width a Polaris Sportsman



### GLACIER® II PLOW SYSTEM: THE FASTEST INSTALL AROUND



Align frame blade to plow mount



Slide blade and frame into mount

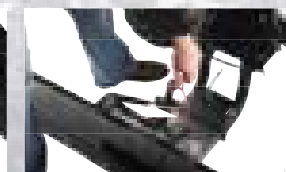

Attach lift cable and place the plow into position

# PLOWS

## GLACIER® II PLOW SYSTEM

Designed by Polaris with quick-attach capability, this is the ultimate plow system for your Polaris Sportsman. It features a new and improved mount plate and frame. It's easy to operate and maneuver, and incorporates our exclusive Lock & Ride® technology that lets you attach or detach the plow in seconds.



### ORDERING A POLARIS PLOW SYSTEM

#### STEP 1

##### SELECT A MOUNT

Our mount plates are designed exclusively for Sportsman models, not a "generic fit" design like our competitors.

#### 1 SELECT A MOUNT

##### GLACIER II MOUNT PLATE

PART NO. 2876593

FITMENT Sportsman XP MY 09-10, XP Touring, XP X2

PART NO. 2877944

FITMENT Sportsman MY 05-10

PART NO. 2876625

FITMENT Sportsman 300/400 Hawkeye

#### 2 SELECT A PLOW FRAME

##### GLACIER II PLOW FRAME

PART NO. 2876594

FITMENT Sportsman XP

PART NO. 2876623

FITMENT All models except XP

#### STEP 2

##### SELECT A FRAME

Lock & Ride® - easy on/off

#### 3 SELECT A LIFT METHOD

##### POLARIS 1587 KG WINCH

PART NO. 2876591

FITMENT Sportsman XP 550/850 MY 09, Sportsman XP Touring & X2 550/850 MY 10

PART NO. 2877303

FITMENT Sportsman MY 05-10

PART NO. 2877820

FITMENT Sportsman XP 550/850 MY 10

##### POLARIS 1133 KG WINCH

PART NO. 2876592

FITMENT Sportsman XP 550/850 MY 09, Sportsman XP Touring & X2 550/850 MY 10

PART NO. 2877302

FITMENT Sportsman MY 05-10

PART NO. 2877819

FITMENT Sportsman XP 550/850 MY 10

##### POLARIS 680 KG WINCH

PART NO. 2875880

FITMENT Sportsman 300, Hawkeye

PART NO. 2876639

FITMENT Sportsman 400

##### WARN® RT 30 WINCH

PART NO. 2877455

FITMENT Sportsman XP 550/850 MY 09, Sportsman XP Touring & X2 550/850 MY 10

PART NO. 2876819

FITMENT Sportsman MY 05-10

PART NO. 2877821

FITMENT Sportsman XP 550 & 850 MY 10

#### STEP 3

##### SELECT A LIFT METHOD

Choose a Polaris winch or Polaris Warn® winch.

#### STEP 4

##### SELECT A PLOW BLADE

Select a blade from our variety of sizes and capabilities. All blades fit all our plow frames.

#### 4 SELECT A PLOW BLADE

##### 152 CM SNOW BLADE

PART NO. 2876626

##### 132 CM SNOW BLADE

PART NO. 2876627

##### 122 CM SNOW/DIRT BLADE

PART NO. 2876814

##### 152 CM RAZOR TWO-WAY BLADE

■ A dual one-way blade

PART NO. 2875370

##### 122 CM ONE-WAY BLADE W/ DEFLECTOR

■ The perfect angle to throw snow up and over banks

■ Made of powder-coated steel

PART NO. 2872684

## GLACIER® I PLOW SYSTEM

Winner of the 2005 Product Innovation Award from ATV Magazine, this is the system that started the Polaris Lock & Ride® plow revolution. This system does not fit the Sportsman XP.



### ORDERING A POLARIS PLOW SYSTEM

#### STEP 1

##### SELECT A MOUNT

Our mount plates are designed exclusively for Sportsman models, not a "generic fit" design like our competitors.

#### 1 SELECT A MOUNT

##### GLACIER I MOUNT PLATE

PART NO. 2876842

FITMENT Sportsman Gen VI, Gen IV+, Sportsman MY 05-10 twin cylinder engines

PART NO. 2876841

FITMENT Sportsman Gen VI 400/500, Sportsman MY 07-10 single cylinder engines (Needed for Sportsman X2 Mount Adaptor #2876020)

PART NO. 2874775

FITMENT ATP/Gen IV, 6x6 (Installs using existing mounting holes)

##### SPORTSMAN X2 MOUNT ADAPTOR

PART NO. 2876020

FITMENT Sportsman X2 [Must use with #2876841] MY 06-09

#### 2 SELECT A PLOW FRAME

##### GLACIER I PLOW FRAME

PART NO. 2876840

FITMENT Sportsman MY 05-10

#### STEP 2

##### SELECT A FRAME

Lock & Ride® - easy on/off

#### 3 SELECT A LIFT METHOD

##### POLARIS 1587 KG WINCH

PART NO. 2877303

FITMENT Sportsman MY 05-10

##### POLARIS 1133 KG WINCH

PART NO. 2877302

FITMENT Sportsman MY 05-10

##### WARN® RT 30 WINCH

PART NO. 2876819

FITMENT Sportsman MY 05-10

##### 226 KG PLOW LIFT

PART NO. 2875881

FITMENT Must order #2854644 (Mount and Strap Kit)

#### STEP 4

##### SELECT A PLOW BLADE

Select a blade from our variety of sizes and capabilities. All blades fit all our plow frames.

#### 4 SELECT A PLOW BLADE

##### 152 CM SNOW BLADE

PART NO. 2876626

##### 132 CM SNOW BLADE

PART NO. 2876627

##### 122 CM SNOW/DIRT BLADE

PART NO. 2876814

##### 152 CM RAZOR TWO-WAY BLADE

■ A dual one-way blade

PART NO. 2875370

##### 122 CM ONE-WAY BLADE W/ DEFLECTOR

■ The perfect angle to throw snow up and over banks

■ Made of powder-coated steel

PART NO. 2872684

WINCHES  
PG. 116 - 117

PLOWS  
PG. 118 - 123

TRACKS  
PG. 124 - 125

RIMS & TIRES  
PG. 126 - 129

WINDSHIELDS  
PG. 130 - 131

PROTECTION  
PG. 132 - 135

STORAGE  
PG. 136 - 144

MOWERS  
PG. 145

CUSTOM  
PG. 146 - 147

TRAILERING  
PG. 148 - 149

ENTRY  
PG. 150 - 151

FIT CHARTS  
PG. 190 - 203



# PLOWS



## EASY LIFT PLOW

Engineered specifically for Polaris ATVs, the Easy Plow Lift is the perfect choice for anyone doing light-duty and residential plowing. It's rugged yet affordable. The integrated hand lever is designed to give you good leverage so it's easy to lift and lower the plow blade. Follow the step-by-step process below to build the perfect, no-frills plow package for your Polaris ATV.

### ORDERING A POLARIS PLOW SYSTEM

#### STEP 1

##### SELECT A MOUNT

Our mount plates are designed exclusively for Sportsman models, not a "generic fit" design like our competitors.

#### STEP 2

##### SELECT A FRAME

Lock & Ride® - easy on/off

#### STEP 3

##### SELECT A PLOW BLADE

Select a blade from our variety of sizes and capabilities. All blades fit all our plow frames.

#### 1 SELECT A MOUNT

##### EASY LIFT PLOW MOUNT

PART NO. 2877261

FITMENT Sportsman XP 550/850

PART NO. 2877380

FITMENT Sportsman X2 & Touring 500/800

PART NO. 2877259

FITMENT Sportsman 600/700/800 MY 05-10

PART NO. 2877469

FITMENT Sportsman Twin MY 02-04

#### 2 SELECT A PLOW FRAME

##### EASY LIFT PLOW FRAME

PART NO. 2877262

##### FRAME EXTENSION

- Allows use of Easy Lift plow with tracks
- Use winch to lift with extension installed

PART NO. 2878021

#### 3 SELECT A BLADE

##### 152 CM SNOW BLADE

PART NO. 2876626

##### 132 CM SNOW BLADE

PART NO. 2876627

##### 122 CM SNOW/DIRT BLADE

PART NO. 2876814

##### 152 CM RAZOR TWO-WAY BLADE

- A dual one-way blade

PART NO. 2875370

##### 122 CM ONE-WAY BLADE W/ DEFLECTOR

- The perfect angle to throw snow up and over banks
- Made of hardened, powder-coated steel

PART NO. 2872684

A



#### A. 152 CM FLOATING WEAR BAR

- Prevents blade from cutting into gravel or sod
- Made of hardened steel

PART NO. 2875369

B



#### B. STANDARD WEAR BARS

- Replaces stock wear bar for snow blades

##### 152 CM STANDARD WEAR BAR

PART NO. 2877243

##### 132 CM STANDARD WEAR BAR

PART NO. 2877210

##### 122 CM STANDARD WEAR BAR

PART NO. 2877244

##### V-PLOW STANDARD WEAR BAR

PART NO. 2871980

#### C. SUPER HEAVY-DUTY WEAR BARS

- Made of hardened steel for serious plowing
- Lasts longer than standard wear bars

##### 152 CM HEAVY-DUTY WEAR BAR

PART NO. 2873426

##### 132 CM HEAVY-DUTY WEAR BAR

PART NO. 2873424

##### 122 CM HEAVY-DUTY WEAR BAR

PART NO. 2873425

E

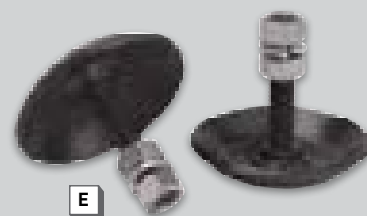

#### D. SNOW DEFLECTORS

- Helps confine snow, boosting plow capacity
- Keeps snow or dirt moving in right direction
- Designed for easy on and off
- Fits 122 cm, 132 cm, 152 cm blades and V-plows

#### SIDE PANEL DEFLECTORS

PART NO. 2872061

#### V-PLOW BLADE SNOW DEFLECTOR

PART NO. 2872006

#### 152 CM PLOW BLADE SNOW DEFLECTOR

PART NO. 2871808

F

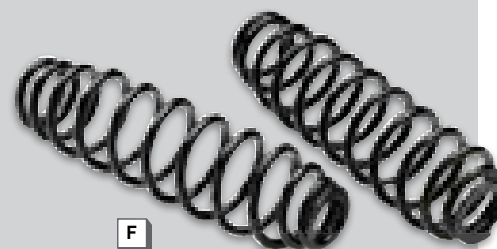

#### E. SUPER HEAVY-DUTY SKID SHOES

- Helps prevent blade wear
- Hardened steel for industrial strength
- More durable than stock skid shoes

PART NO. 2873423

#### F. HEAVY-DUTY FRONT SUSPENSION SPRINGS

- Stiffer springs replace stock springs
- Ideal for carrying heavier loads
- Increases lift while snow plowing

PART NO. 2876153

FITMENT Sportsman MY 05-10

G



#### G. COIL SPRING SPACER

- Weight of plow compresses front suspension
- Spacer reduces compression, increases leverage
- Use in single or multiple pairs for greater lift

PART NO. 2872655

#### H. FRONT SPRING PRE-LOAD ADJUSTERS

- Everything you need to adjust spring pre-load
- Helps you match suspension to load

PART NO. 2876463

FITMENT Sportsman MY 05-10

H



I



#### I. PLOW MARKER

- Helps driver monitor plow blade position

PART NO. 2872726

#### J. REAR TIRE CHAINS

- Size C, for 63.5 cm or 66 cm tires

PART NO. 2870948

J



WINCHES  
PG. 116 - 117

PLOWS  
PG. 118 - 123

TRACKS  
PG. 124 - 125

RIMS & TIRES  
PG. 126 - 129

WINDSHIELDS  
PG. 130 - 131

PROTECTION  
PG. 132 - 135

STORAGE  
PG. 136 - 144

MOWERS  
PG. 145

CUSTOM  
PG. 146 - 147

TRAILERING  
PG. 148 - 149

ENTRY  
PG. 150 - 151

FIT CHARTS  
PG. 190 - 203

# TRACKS

**GO ANYWHERE.** This is the most advanced track system ever built for Polaris ATVs. With its many rugged, uniquely engineered features, it truly is the ultimate all-season, all-terrain AWD track system for your Polaris Sportsman. It delivers excellent low-end performance in deep mud, swamps, bogs and snow. It holds traction better than its competition. And it's designed for an exact fit.



ORDERING IS EASY

**STEP 1** SELECT A TRACK MOUNT

**STEP 2** SELECT A TRACK KIT

## 1 SELECT A TRACK MOUNT

### PROSPECTOR TRACK MOUNT KIT

- PART NO.** 2876617
- FITMENT** Sportsman XP 550/850 MY 10
- PART NO.** 2876617
- FITMENT** Sportsman XP 550/850 MY 09, Touring X2 550/850 MY10
- PART NO.** 2876880
- FITMENT** Sportsman MY 05-10
- PART NO.** 2876659
- FITMENT** Sportsman X2 500/800 MY 08-10, Touring
- PART NO.** 2876881
- FITMENT** Sportsman X2 MY 06-07

## 2 SELECT A TRACK KIT

### PROSPECTOR PRO-S TRACK KIT

- Fine-tuned gear ratio to optimize track spin
- Long rear footprint for superior flotation
- Requires Mount Kit

**PART NO.** 2877539

**FITMENT** All Sportsman MY 05-10 except Sportsman 300/400

### PROSPECTOR PRO-S UPDATE KIT

- Allows updating a Prospector Pro to a Pro-S
- Improved gear ratio and longer rear footprint

**PART NO.** 2877540

**FITMENT** All Prospector Pro Track Kits

### ATTENTION

Use Frame Extension 2878021 with the Easy Lift Plow System when installing a plow on an ATV with tracks.

Steering is easy, in mud, boggy terrain or snow, for longer rides with less fatigue.

Optimized gearing for superior low-end performance and true AWD.

True all-season, all-terrain capability

Features large-diameter corner wheels to increase the approach angle and easily clear obstacles.

## HOW PROSPECTOR PRO STACKS UP

### FEATURES:

	TATOU™ 4S	MATTRACKS™	CATTRAXX	TJD™ X-GEN
For use in any season, any condition, without the fear of wearing tracks down.	✓	✓	✗	✗
Greasable hub necessary for mud usage.	✓	✗	✗	✗
Large diameter drive socket for great speed, without compromising stability and ground clearance. Power comes from the engine, without over revving.	✓	✗	✗	✗
Track is designed for all conditions, including snow.	✓	✗	✗	✗
Perfectly designed approach angle for maximizing climbing over large objects.	✓	✗	✗	✓
Internal drive system increases flotation, provides less maintenance and is true all-season performance.	✓	✓	✗	✗
Optimize front and rear sprocket ratio for Polaris true AWD system.	✓	✗	✗	✗
One track fits all Polaris Sportsmans optimizing fitment and performance, without sacrificing strength.	✓	✗	✗	✗

Spring loaded anti-rotation, incredible traction and flotation, longer wear and less maintenance.

OUTSIDE VIEW  
Prospector Pro Tracks

IN SIDE VIEW  
Prospector Pro Tracks

WWW.PUREPOLARIS.COM



EXPERIENCE PROSPECTOR PRO TRACKS IN FULL MOTION VIDEO.



\* Tatou® is the registered trademark of Tatou, Inc. Mattracks® is the registered trademark of Trade Division of National Transmission. TJD® is the registered trademark of Les Fabrications TJD Inc.



## RIMS & TIRES

>>>

**TURF, TRAILS, MUD.** There's a lot of different terrain out there. That's why Pure Polaris offers such a wide variety of tires, including our big 66 cm Maxxis® Bighorn™ Tires mounted on our all-new 36 cm machined and flat black SIXr Rims. Check out our huge selection of rims, many available in black or silver. Buy just the rims or go with the complete tire/rim package. Either way, you know you're riding on high-quality products from Pure Polaris.



A

**NEW  
2010**



B



### A. 36 CM SIXr RIMS WITH 66 CM MAXXIS® BIGHORN® TIRES

- Our newest custom rims feature a dual 6-spoke design
- Radial construction creates a smooth ride on dirt, rocks and desert
- Features extra lugs on shoulder to protect sidewall and rim
- Raised lettering on one side
- Lug nuts sold separately

### 36 CM FLAT BLACK SIXr RIMS WITH 66 CM MAXXIS® BIGHORN® TIRES

PART NO. 2878030  
 QUANTITY Set of 4  
 RIM SPEC 36 cm x 18 cm (Front); 36 cm x 20 cm (Rear)  
 TIRE SPEC 66 cm x 23 cm x 36 cm (Front); 66 cm x 28 cm x 36 cm (Rear)  
 FITMENT All Sportsman (except XP, and 300/400)

### 36 CM MACHINED SIXr RIMS WITH 66 CM MAXXIS® BIGHORN® TIRES

PART NO. 2878032  
 QUANTITY Set of 4  
 RIM SPEC 36 cm x 18 cm (Front); 36 cm x 20 cm (Rear)  
 TIRE SPEC 66 cm x 23 cm x 36 cm (Front); 66 cm x 28 cm x 36 cm (Rear)  
 FITMENT All Sportsman (except XP, and 300/400)

### B. 36 CM SPORTSMAN™ XP RIMS WITH VISION TRAILFINDER™ TIRES

- Unique, automotive-inspired, 8-spoke rims with center cap design
- Tread pattern delivers excellent mud, trail and off-road performance
- Lug nuts sold separately

PART NO. 2877386  
 QUANTITY Set of 4  
 RIM SPEC 36 cm x 18 cm (Front); 36 cm x 20 cm (Rear)  
 TIRE SPEC 66 cm x 25 cm x 36 cm (Front); 66 cm x 30.5 cm x 36 cm (Rear)  
 FITMENT Sportsman XP, XP Touring, X2 MY 10



C



D



E

### C. 36 CM CRUSHER RIMS WITH MAXXIS® BIGHORN® TIRES

- Custom 8-spoke Crusher Rim design is a Polaris exclusive
- Radial construction creates a smooth ride on dirt, rocks and desert
- Features extra lugs on shoulder to protect sidewall and rim
- Raised lettering on one side
- Lug nuts sold separately

### 36 CM BLACK CRUSHER RIMS WITH 66 CM MAXXIS® BIGHORN® TIRES

PART NO. 2877159  
 QUANTITY Set of 4  
 RIM SPEC 36 cm x 18 cm (Front); 36 cm x 20 cm (Rear)  
 TIRE SPEC 66 cm x 23 cm x 36 cm (Front); 66 cm x 28 cm x 36 cm (Rear)  
 FITMENT All Sportsman (except XP, and 300/400)

### 36 CM SILVER CRUSHER RIMS WITH 66 CM MAXXIS® BIGHORN® TIRES

PART NO. 2876907  
 QUANTITY Set of 4  
 RIM SPEC 36 cm x 18 cm (Front); 36 cm x 20 cm (Rear)  
 TIRE SPEC 66 cm x 23 cm x 36 cm (Front); 66 cm x 28 cm x 36 cm (Rear)  
 FITMENT All Sportsman (except XP, and 300/400)

### D. 36-38 CM BUCKSHOT RIMS WITH VISION TRAILFINDER™ TIRES

- Unique, automotive-inspired, 8-spoke Buckshot design
- Choose 36 cm or industry's first 38 cm rims
- Tread pattern delivers excellent mud, trail and off-road performance
- Lug nuts sold separately

### 36 CM BUCKSHOT RIMS WITH 66 CM VISION TRAILFINDER™ TIRES

PART NO. 2877605  
 QUANTITY Set of 4  
 RIM SPEC 36 cm x 18 cm (Front); 36 cm x 20 cm (Rear)  
 TIRE SPEC 15 cm x 25 cm x 36 cm (Front); 66 cm x 30.5 cm x 36 cm (Rear)  
 FITMENT All Sportsman (except XP, and 300/400)

### 38 CM BUCKSHOT RIMS WITH 66 CM VISION TRAILFINDER TIRES

PART NO. 2877604  
 QUANTITY Set of 4  
 RIM SPEC 38 cm x 18 cm (Front); 38 cm x 20 cm (Rear)  
 TIRE SPEC 66 cm x 25 cm x 38 cm (Front); 66 cm x 30.5 cm x 38 cm (Rear)  
 FITMENT All Sportsman (except XP, and 300/400)

### E. 36 CM BRUISER RIMS WITH MAXXIS® BIGHORN® TIRES

- Beefy, 4-spoke Bruiser Rim design is a Polaris exclusive
- Radial construction creates a smooth ride on dirt, rocks and desert
- Features extra lugs on shoulder to protect sidewall and rim
- Raised lettering on one side
- Lug nuts sold separately

PART NO. 2876944  
 QUANTITY Set of 4  
 RIM SPEC 36 cm x 18 cm (Front); 36 cm x 20 cm (Rear)  
 TIRE SPEC 66 cm x 23 cm x 36 cm (Front); 66 cm x 23 cm x 36 cm (Rear)  
 FITMENT All Sportsman (except XP, and 300/400)



# RIMS & TIRES

## A. 14-38 CM BUCKSHOT RIMS

- Unique, automotive-inspired, 8-spoke Buckshot design
- Choose 36 cm or industry's first 38 cm rims

### 38 CM BUCKSHOT RIMS

PART NO. 1521431  
SPEC Front 38 cm x 18 cm

PART NO. 1521432  
SPEC Rear 38 cm x 20 cm  
FITMENT Sportsman MY 05-10 (except XP, and 300/400)

### 36 CM BUCKSHOT RIMS

PART NO. 1521433  
SPEC Front 36 cm x 18 cm

PART NO. 1521434  
SPEC Rear 36 cm x 20 cm  
FITMENT Sportsman MY 05-10 (except XP, and 300/400)

## B. 36 CM SIXr RIMS

- Our newest custom rim features a dual 6-spoke design
- Choose flat black or machined

### 36 CM FLAT BLACK SIXr RIMS

PART NO. 1521507-521  
SPEC Front 36 cm x 18 cm

PART NO. 1521508-521  
SPEC Rear 36 cm x 20 cm  
FITMENT Sportsman MY 05-10 (except XP, and 300/400)

### 36 CM MACHINED SIXr RIMS

PART NO. 1521507-266  
SPEC Front 36 cm x 18 cm

PART NO. 1521508-266  
SPEC Rear 36 cm x 20 cm  
FITMENT Sportsman MY 05-10 (except XP, and 300/400)



## C. 36 CM CRUSHER RIMS

- Custom 8-spoke Crusher Rim design is a Polaris exclusive
- Cast aluminum for strength and light weight

### 36 CM BLACK CRUSHER RIMS

PART NO. 2877157  
SPEC Front 36 cm x 18 cm

PART NO. 2877158  
SPEC Rear 36 cm x 20 cm  
FITMENT Sportsman MY 05-10 (except XP, and 300/400)

### 36 CM SILVER CRUSHER RIMS

PART NO. 2876281  
SPEC Front 36 cm x 18 cm

PART NO. 2876282  
SPEC Rear 36 cm x 20 cm  
FITMENT Sportsman MY 05-10 (except XP, and 300/400)

## E. 36 CM SPORTSMAN XP RIMS

- Unique, automotive-inspired, 8-spoke rims with center cap design

PART NO. 1521402  
SPEC Front 36 cm x 18 cm

PART NO. 1521403  
SPEC Rear 36 cm x 20 cm  
FITMENT Sportsman XP

## D. 30.5 CM BRUISER RIMS

- Beefy, 4-spoke Bruiser Rim design is a Polaris exclusive
- Cast aluminum for strength and light weight

### 36 CM BRUISER RIMS

PART NO. 2875904  
SPEC Front 36 cm x 18 cm

PART NO. 2875905  
SPEC Rear 36 cm x 20 cm  
FITMENT Sportsman MY 05-10 (except 6x6, XP, and 300/400)

### 30.5 CM BRUISER RIMS

PART NO. 2875902  
SPEC Front 30.5 cm x 18 cm

PART NO. 2875903  
SPEC Rear 30.5 cm x 20 cm  
FITMENT Sportsman MY 05-10 (except XP), and MY 06-07 Hawkeye

## F. 30.5 CM CAST ALUMINUM RIMS

- Classic 8-spoke design, a Polaris exclusive
- Cast aluminum for strength and light weight
- Machined center cap within the wheel

PART NO. 2876086  
SPEC Front 30.5 cm x 15 cm

PART NO. 2876087  
SPEC Rear 30.5 cm x 20 cm  
FITMENT Sportsman MY 05-10 (except XP), and MY 06-07 Hawkeye

## G. MAXXIS® BIGHORN® TIRES

- Radial construction creates a smooth ride on dirt, rocks and desert
- Features extra lugs on shoulder to protect sidewall and rim
- Raised lettering on one side

PART NO. 2876905  
SPEC Front 66 cm x 23 cm x 36 cm

FITMENT 36 cm x 18 cm Front Tire

PART NO. 2876906  
SPEC Rear 66 cm x 28 cm x 36 cm

FITMENT 36 cm x 20 cm Rear Tire

## H. 36-38 CM VISION TRAILFINDER® TIRES

- Tread pattern delivers a smooth ride on the trail
- Excellent mud and off-road performance

PART NO. 5413726  
SPEC Front 66 cm x 25 cm x 38 cm

FITMENT 38 cm x 18 cm Front Tire

PART NO. 5413727  
SPEC Rear 66 cm x 30.5 cm x 38 cm

FITMENT 38 cm x 20 cm Rear Tire

PART NO. 5413659  
SPEC Front 66 cm x 25 cm x 36 cm

FITMENT 36 cm x 18 cm Front Tire

PART NO. 5413660  
SPEC Rear 66 cm x 30.5 cm x 36 cm

FITMENT 36 cm x 20 cm Rear Tire

## I. 36 CM GOODYEAR® MTR TIRES

- Features an aggressive mud-tire tread pattern
- Delivers sharp steering response and all-day comfort
- 6-ply rating

PART NO. 5413409  
SPEC Front 63.5 cm x 20 cm x 30.5 cm

FITMENT 30.5 cm x 18 cm Front Tire

PART NO. 5413410  
SPEC Rear 63.5 cm x 25 cm x 30.5 cm

FITMENT 30.5 cm x 20 cm Rear Tire

## J. KENDA® EXECUTIONER™ TIRES

- Rugged tire features 6-ply construction
- Rim-saver protects from rocks and debris
- Dimple tread surface improves traction

PART NO. 2875235  
SPEC Front 66 cm x 23 cm x 36 cm

FITMENT 36 cm x 18 cm Front Tire

PART NO. 2875234  
SPEC Rear 66 cm x 28 cm x 36 cm

FITMENT 36 cm x 20 cm Rear Tire

## K. SPORTSMAN LOAD BOSS TURF TIRES

- Six-ply turf tires are perfect for driving on lawns while mowing or hauling
- Avoids damage by dispersing tire pressure across turf-tread pattern
- Tires fit on 30.5 cm stock rims (not included)
- Tires sold individually, lug nuts sold separately

PART NO. 2875796  
SPEC Front 63.5 cm x 20 cm x 30.5 cm

FITMENT All Sportsman (except 6x6)

PART NO. 2875795  
SPEC Rear 263.5 cm x 25 cm x 30.5 cm

FITMENT All Sportsman (except 6x6)

## L. CARLISLE™ ACT TIRES

- A great all-purpose, all-terrain tire
- Designed for both wet and dry conditions
- Sidewall design ensures a smooth ride

PART NO. 2876084  
SPEC Front 58 cm x 18 cm x 30.5 cm

FITMENT 30.5 cm x 18 cm Front Tire

PART NO. 2876085  
SPEC Rear 58 cm x 25 cm x 30.5 cm

FITMENT 30.5 cm x 20 cm Rear Tire



### SAE LUG NUTS FOR ALUMINUM RIMS

PART NO. 2876754  
QUANTITY Set of 4  
FITMENT All Sportsman (except XP)

PART NO. 2877409  
QUANTITY Set of 16  
FITMENT All Sportsman (except XP)

### METRIC LUG NUTS FOR ALUMINUM RIMS

PART NO. 2877385  
QUANTITY Set of 4  
FITMENT Sportsman XP

PART NO. 2877384  
QUANTITY Set of 16  
FITMENT Sportsman XP

### BRUISER & CRUSHER CENTER CAP

PART NO. 2854604

### CHROME SIXr CENTER CAP

PART NO. 1521509-410

### FLAT BLACK SIXr CENTER CAP

PART NO. 1521509-521



# WINDSHIELDS

**LOCK & RIDE® FOR EASY ON/OFF.** These are not just the best built windshields for your Polaris ATV, they're also the fastest-attaching windshields. They go on and off in seconds, so you can change your mind faster than the weather forecast. Choose from three heights to match your riding style and body type.

## INSTALLING A WINDSHIELD



Place clamps on handlebars



Align clamps with hinge



Lock clamps down

Height measured from top of pod to top of windshield.

Polaris windshields are made with premium polycarbonate for ultimate durability and thickness.



[WWW.PUREPOLARIS.COM](http://WWW.PUREPOLARIS.COM)



EXPERIENCE LOCK & RIDE IN FULL MOTION VIDEO.

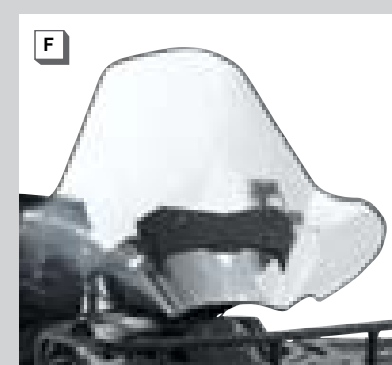
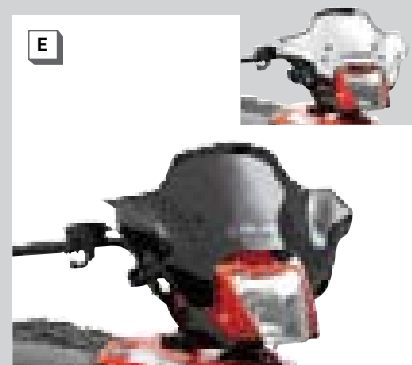
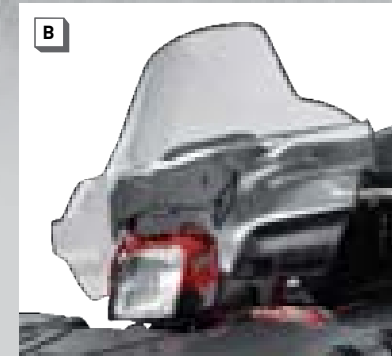

### A. XP TALL LOCK & RIDE® WINDSHIELD

PART NO. 2876606

FITMENT 49 cm Windshields, Sportsman XP

### B. XP MID LOCK & RIDE® TINTED WINDSHIELD

PART NO. 2876609

FITMENT 39 cm Windshields, Sportsman XP

### C. XP LOW LOCK & RIDE® WINDSHIELD

BLACK XP LOW LOCK & RIDE WINDSHIELD

PART NO. 2876608

FITMENT 24 cm Windshields, Sportsman XP

### CHROME XP LOW LOCK & RIDE WINDSHIELD

PART NO. 2876610

FITMENT 24 cm Windshields, Sportsman XP

### D. SPORTSMAN TALL & MID LOCK & RIDE® WINDSHIELD

PART NO. 2876017

FITMENT 19.25 cm Sportsman MY 05-10

PART NO. 2876018

FITMENT 45 cm Sportsman MY 05-10

### E. SPORTSMAN LOW LOCK & RIDE® WINDSHIELD

BLACK LOW LOCK & RIDE WINDSHIELD

PART NO. 2875781

FITMENT 24 cm Sportsman MY 05-10,

### CHROME LOW LOCK & RIDE WINDSHIELD

PART NO. 2875805

FITMENT 24 cm Sportsman MY 05-10

### F. SPORTSMAN 300/400 LOCK & RIDE® WINDSHIELD

PART NO. 2875682

FITMENT 47 cm Sportsman 300/400 HO MY 08-10, Hawkeye MY 06-07

### G. HANDGUARDS

- Protects your hands from branches and cold air
- Made of strong, injection-molded plastic
- Includes mounting hardware

PART NO. 2875709-177

FITMENT Sportsman 07-10, All Sportsman XP MY 09-10 (except 6x6)

PART NO. 2874871-177

FITMENT Sportsman 300/400

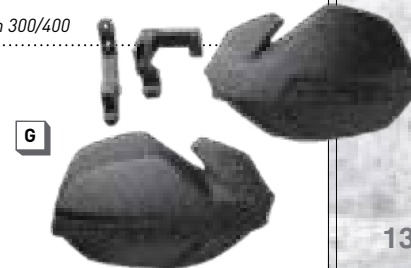

## WHAT WINDSHIELD IS RIGHT FOR ME? >

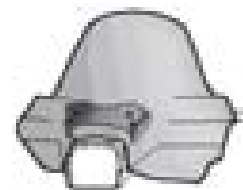

### TALL WINDSHIELD

At over 49 cm tall, it offers full hand and upper body protection, and is the ideal choice for taller riders and for riding in extreme conditions and cold temperatures.

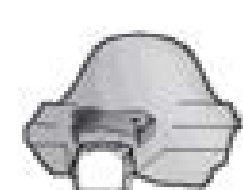

### MID WINDSHIELD

This all-purpose windshield is 38 cm tall, perfect for riders who want hand and upper body protection from the elements in a slightly lower, custom design.



### LOW WINDSHIELD

At 24 cm tall, our low windshields give your ATV a sweet custom look as well as lower body protection from wind and dust.

WINCHES  
PG. 116 - 117

PLOWS  
PG. 118 - 123

TRACKS  
PG. 124 - 125

RIMS & TIRES  
PG. 126 - 129

WINDSHIELDS  
PG. 130 - 131

PROTECTION  
PG. 132 - 135

STORAGE  
PG. 136 - 144

MOWERS  
PG. 145

CUSTOM  
PG. 146 - 147

TRAILERING  
PG. 148 - 149

ENTRY  
PG. 150 - 151

FIT CHARTS  
PG. 190 - 203

# PROTECTION

>>>

**GUARD YOUR ATV.** Superior protection and quality for your ATV. Choose from a variety of models to get exactly what you want in off-road protection and customization. They're designed to fit perfectly and give you rugged, long-lasting durability.



## A. SPORTSMAN® XP DELUXE BRUSHGUARDS

- Built to give your Sportsman XP added protection and a great look
- Front brushguards have mounting tabs to add lights

### FRONT BRUSHGUARD

PART NO. 2876595  
 COLOR Black Wrinkle  
 FITMENT Sportsman XP, Touring, X2 550/850

### REAR BRUSHGUARD

PART NO. 2876597  
 COLOR Black Wrinkle  
 FITMENT Sportsman XP, Touring, X2 550/850



ORDERING IS EASY

STEP 1

SELECT A WIRE HARNESS

STEP 2

SELECT LIGHTS

### BRUSHGUARD LIGHTS

- Great for riding in low light and at night
- Front grilles protect lenses from trail debris

### 1 SELECT A WIRE HARNESS

#### FRONT BUMPER WIRE HARNESS

PART NO. 2877399  
 FITMENT For fog lights

### 2 SELECT LIGHTS

#### B. PIAA™ 35 WATT LIGHT

PART NO. 2876684  
 FITMENT Polaris XP Front Brushguards

#### C. 35 WATT RALLY LIGHT

PART NO. 2877335  
 FITMENT Polaris XP Front Brushguards

## D. SPORTSMAN® XP EXTREME BRUSHGUARDS

- Low-profile design adds protection and a custom look
- Front brushguards have mounting tabs to add lights

### FRONT BRUSHGUARD

PART NO. 2876596  
 COLOR Black Wrinkle  
 FITMENT Sportsman XP, Touring, X2 550/850

### REAR BRUSHGUARD

PART NO. 2876607  
 COLOR Black Wrinkle  
 FITMENT Sportsman XP, Touring, X2 550/850

## E. DELUXE FRONT BRUSHGUARD

- Gives the grille and headlights added protection
- Creates a custom look that sets your ATV apart

### FRONT BRUSHGUARD

PART NO. 2876102-418  
 COLOR Black Wrinkle  
 FITMENT Sportsman MY 05-10, X2, Touring 500/800

## F. REAR BRUSHGUARD

- A great addition in both form and function
- Tough, 5 cm diameter tubing

### FRONT BRUSHGUARD

PART NO. 2875174-418  
 COLOR Black Wrinkle  
 FITMENT Sportsman MY 05-10

## G. DOUBLE TUBE FRONT BRUSHGUARD

- Double 5 cm diameter tubes make for one tough brushguard
- Unique styling says "get out of the way"

### FRONT BRUSHGUARD

PART NO. 2875175-418  
 COLOR Black Wrinkle  
 FITMENT Sportsman MY 05-10, X2, Touring 500/800

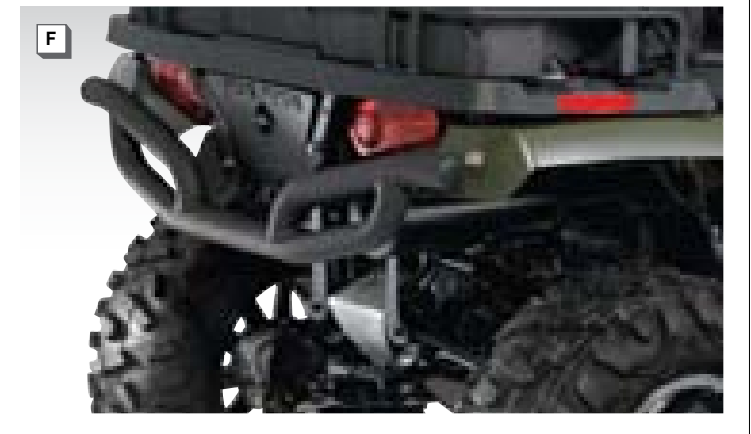
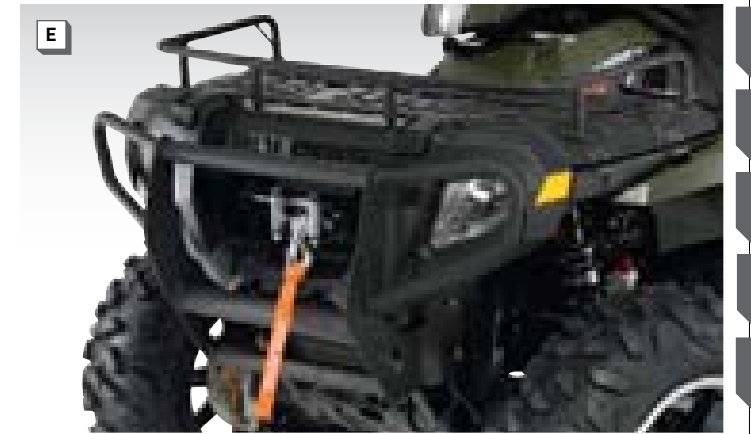

2010 ATV UTILITY

WINCHES  
PG. 116 - 117

PLOWS  
PG. 118 - 123

TRACKS  
PG. 124 - 125

RIMS & TIRES  
PG. 126 - 129

WINDSHIELDS  
PG. 130 - 131

PROTECTION  
PG. 132 - 135

STORAGE  
PG. 136 - 144

MOWERS  
PG. 145

CUSTOM  
PG. 146 - 147

TRAILERING  
PG. 148 - 149

ENTRY  
PG. 150 - 151

FIT CHARTS  
PG. 190 - 203



# PROTECTION

**NEW**  
2010

## A. SPORTSMAN TOURING REAR BRUSHGUARD

- Designed specifically for the Sportsman Touring
- Adds heavy-duty rear protection and a custom look

PART NO. 2877918  
 COLOR Black Wrinkle  
 FITMENT Sportsman Touring 550/850 MY 10



## B. SPORTSMAN X2 REAR BUMPER

- Designed specifically for the Sportsman X2
- Adds style and rear protection

PART NO. 2877686  
 COLOR Black Wrinkle  
 FITMENT Sportsman X2 MY 06-10



**NEW**  
2010

## C. ALUMINUM A-ARM GUARD

- Helps protect A-arms from damage
- Deflects rocks, stumps and trail debris

### FRONT A-ARM GUARD

PART NO. 2877681  
 COLOR Black Wrinkle  
 FITMENT Sportsman XP, X2, Touring 550/850

### REAR A-ARM GUARD

PART NO. 2877682  
 COLOR Black Wrinkle  
 FITMENT Sportsman XP, X2, Touring 550/850

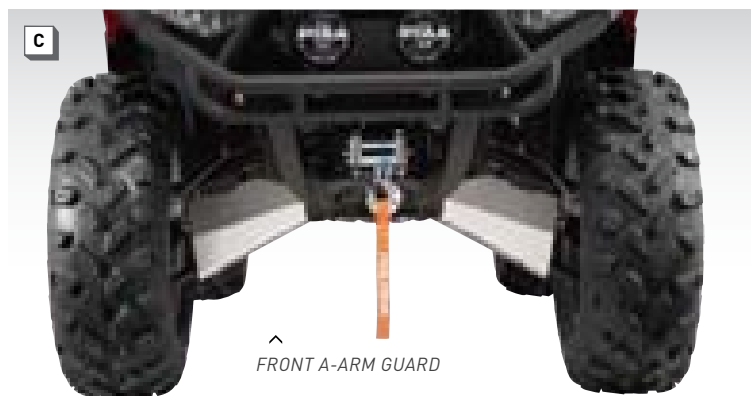

## D. DELUXE FRONT BRUSHGUARD

- Adds excellent front protection
- Tough, wrinkle-black finish

PART NO. 2876637-418  
 COLOR Black Wrinkle  
 FITMENT Sportsman 300/400, Hawkeye

## E. EXTREME FRONT BRUSHGUARD

- Perfect for your mid-size Polaris ATV
- Compatible with winch, and a great look

PART NO. 2875587  
 COLOR Black Wrinkle  
 FITMENT Sportsman 300/400, Hawkeye



## F. FRONT GRILLE SCREEN

- Helps protect steering, angle drive, CV boots

PART NO. 2875888  
 FITMENT Sportsman 300/400, Hawkeye



## G. REAR BRUSHGUARD

- Designed for the Sportsman 300/400
- Protects fenders and tail lights

PART NO. 2876098-418  
 COLOR Black Wrinkle  
 FITMENT Sportsman 300/400, Hawkeye



# STORAGE

**YOU HAVE STUFF.** We have the bags, boxes and baskets, large and small, that you need to bring it along for the ride. Be sure to check out the large selection of items featuring Lock & Ride® technology that attach or detach in seconds without tools. There are 9 pages of storage accessories. Mix and match them to your exact needs. They're from Pure Polaris so you know they'll fit and they're built for years of rugged off-road working, hunting and riding.

## INSTALLING A CARGO BOX

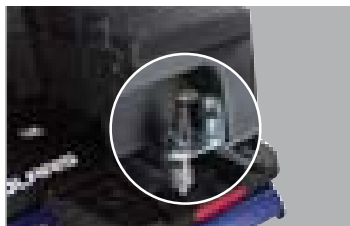

Align the cargo box to the Lock & Ride holes



Insert the expanding anchors into the holes

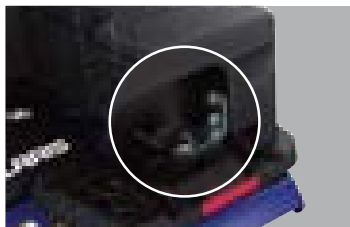

Push down the anchor to lock it in place

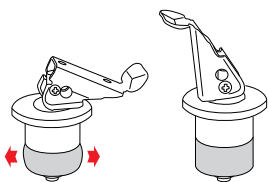

EXPANDED

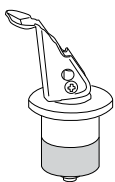

UN-EXPANDED

Put away the tools. Thanks to Lock & Ride® Expansion Anchor Technology from Polaris accessories are on and off in seconds.

[WWW.PUREPOLARIS.COM](http://WWW.PUREPOLARIS.COM)



EXPERIENCE LOCK & RIDE IN FULL MOTION VIDEO.



**NEW 2010**

A

### A. SPORTSMAN® XP LOCK & RIDE® FRONT CARGO BOX

- Replaces front rack, adding convenient storage
- Perfect for carrying and protecting tools and gear

PART NO. 2877951

FITMENT Sportsman XP

### B. SPORTSMAN XP LOCK & RIDE® REAR CARGO BOX

- Large capacity, holds two helmets
- Heavy-duty polyethylene, with lid gasket for tight seal
- Lock & Ride technology for easy on/off
- Locking latches for security
- Works with Rack Extender, Lock & Ride® Backrest, Gun Scabbard and Cargo Pocket Bags

PART NO. 2876601

FITMENT Sportsman XP

### C. SPORTSMAN XP LOCK & RIDE® CARGO BOX BACKREST

- Provides extra back support and comfort on your Sportsman XP
- Attaches to Lock & Ride® Cargo Box
- Fits all Sportsman XP models

PART NO. 2877943

FITMENT Sportsman Lock & Ride Rear Cargo Box (2876601)

### D. SPORTSMAN LOCK & RIDE® REAR CARGO BOX

- Large capacity, with locking latches and lid gaskets
- Molded handles for easy transport
- Works with Rack Extender, Gun Scabbard, Cargo Pocket Bags

PART NO. 2875176

FITMENT Sportsman MY 05-10 500/600/700/800



B

**NEW 2010**

C

### E. SPORTSMAN LOCK & RIDE® REAR CARGO BOX BACKREST

- Provides extra back support and comfort on your Sportsman XP
- Attaches to Lock & Ride® Cargo Box

PART NO. 2876367

fitment Fits Sportsman Lock & Ride® Rear Cargo Box (2875176)



F

D

E

### F. POCKET BAG

- Provides easy access to water, maps, small items
- Straps to cargo box or bag with Velcro® loops
- Works with Sportsman and Sportsman XP Lock & Ride® Rear Cargo Boxes

PART NO. 2875372-070

COLOR Black (Requires attachment loops 2875339)

PART NO. 2875372-419

COLOR Mossy Oak (Requires attachment loops 2875339)

### ATTACHMENT LOOPS

PART NO. 2875339

FITMENT Needed for Pocket Bags



F

WINCHES  
PG. 116 - 117

PLOWS  
PG. 118 - 123

TRACKS  
PG. 124 - 125

RIMS & TIRES  
PG. 126 - 129

WINDSHIELDS  
PG. 130 - 131

PROTECTION  
PG. 132 - 135

STORAGE  
PG. 136 - 144

MOWERS  
PG. 145

CUSTOM  
PG. 146 - 147

TRAILERING  
PG. 148 - 149

ENTRY  
PG. 150 - 151

FIT CHARTS  
PG. 190 - 203



# STORAGE

## A. SPORTSMAN X2 LOCK & RIDE® REAR CARGO BOX

- Lock & Ride® system for easy on/off
- Fits in either side of rear box
- Heavy-duty double-wall lid
- Molded hinges for easy open/close

PART N<sup>o</sup>. 2877921

FITMENT Sportsman X2



## B. LOCK & RIDE® 1-UP TOURING REAR CARGO BOX

- The ideal storage box when riding solo on your Sportsman Touring
- Lock & Ride® technology for easy on/off

PART N<sup>o</sup>. 2876660

FITMENT Sportsman Touring 500/800

PART N<sup>o</sup>. 2877957

FITMENT Sportsman Touring XP 550/850



## C. 1-UP TOURING CARGO BOX BACKREST

- Adds back support and extra comfort when riding solo
- Attaches to 1-Up Touring Rear Cargo Box

PART N<sup>o</sup>. 2877219

FITMENT Lock & Ride® 1-Up Touring Rear Cargo Box 287660, 2877957



## D. LOCK & RIDE® REAR CARGO BOX

- Our largest capacity box for Polaris mid-size ATVs
- Lock & Ride® technology for quick on/off
- Removable top to use as open box
- Molded cargo tray with handles

PART N<sup>o</sup>. 2875678

FITMENT Sportsman 300/400, Hawkeye



## E. SPORTSMAN XP FRONT CARGO BAG

- Provides convenient storage for small tools and gear
- Heavy-duty polyester construction
- Integrated grab handle

PART N<sup>o</sup>. 2876602

FITMENT Sportsman XP



## F. SPORTSMAN XP REAR CARGO BAG

- Designed for riders who need lots of storage
- Built to keep its shape when empty
- Includes sturdy handle for easy transport

PART N<sup>o</sup>. 2876603

FITMENT Sportsman XP



## G. SPORTSMAN XP FRONT POUCH BAG

- Fits under XP front rack
- Stores tools and spare plugs
- Water resistant fabric and zippers

PART N<sup>o</sup>. 2876615

FITMENT Sportsman XP

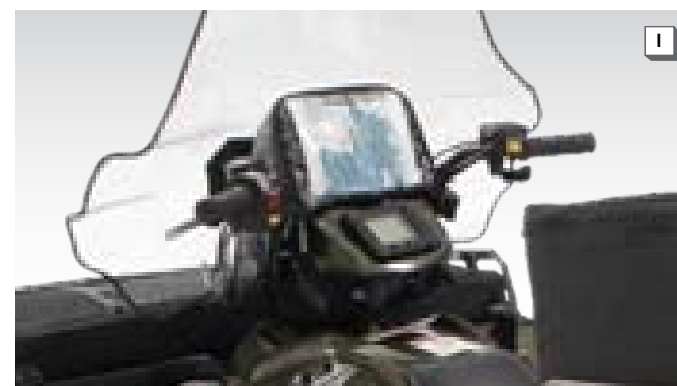

## H. SPORTSMAN XP FENDER BAG

- Perfect place to store gear and food
- Easy to access while seated
- Pockets hold water bottles

PART N<sup>o</sup>. 2876604

FITMENT Sportsman XP, Touring, X2 550/850

## I. SPORTSMAN XP HEADLIGHT POD BAG

- Provides easy access to items
- Features a convenient map pouch

PART N<sup>o</sup>. 2876605

FITMENT Sportsman XP, Touring, X2 550/850

# STORAGE

## A. SPORTSMAN TOURING BACKREST BACKPACK

- Adds extra storage behind passenger seat
- Slips over backrest for easy, secure fit

PART NO. 2876856

FITMENT Sportsman Touring



## B. SEMI-RIGID TOURING CARGO BAG

- Large-capacity, heavy-duty vinyl bag
- 3 zippered openings, removable dividers
- Attaches to rack with Velcro® straps

PART NO. 2877220

FITMENT Sportsman Touring 500/800

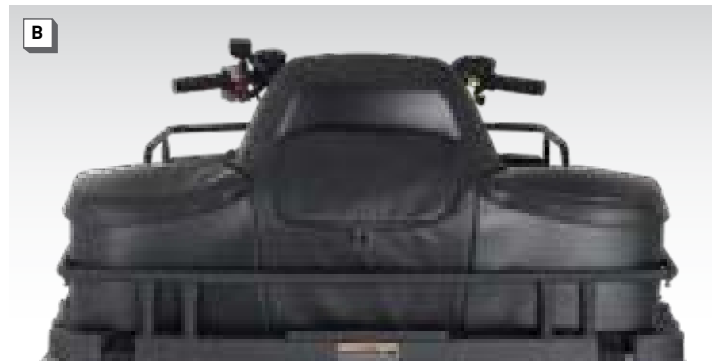

## C. SPORTSMAN X2 DUAL CARGO BAGS

- Secures and protects gear in X2 cargo box
- Heavy-duty 600 denier ballistic material
- Water resistant, with waterproof zippers

PART NO. 2876088

FITMENT Sportsman X2

## D. SPORTSMAN X2 REAR CARGO BAG

- Secures and protects gear
- Straps into X2 cargo box
- Dimensions: 89 cm x 28 cm x 18 cm

PART NO. 2875851

FITMENT Sportsman X2

## E. FRONT & REAR CARGO BAGS

- Heavy-duty polyester construction
- Water resistant; attaches with Velcro® straps
- Dimensions: 79 cm x 30.5 cm x 13 cm

### FRONT CARGO BAG

PART NO. 2875651

FITMENT Sportsman 300/400, Hawkeye

### REAR CARGO BAG

PART NO. 2875677

FITMENT Sportsman 300/400, Hawkeye

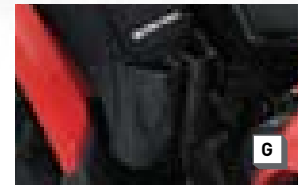
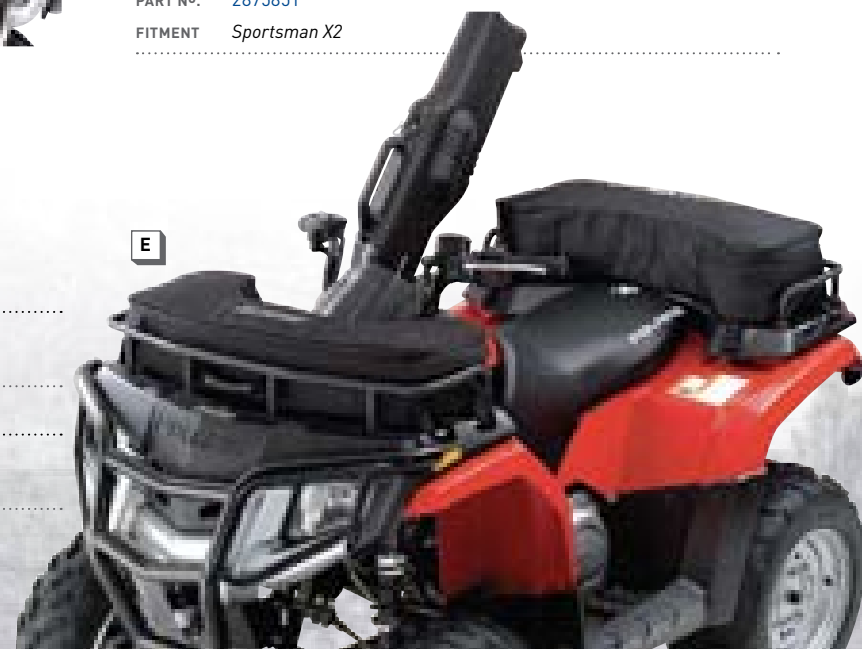

## F. SPORTSMAN REAR CARGO BAG

- Large capacity, made of tough 650 denier polyester
- Built to keep its shape even when empty
- Attaches with Velcro® straps, includes carry handle

### BLACK REAR CARGO BAG

PART NO. 2875307-070

FITMENT Sportsman MY 05-10

### MOSSY OAK REAR CARGO BAG

PART NO. 2875307-070

FITMENT Sportsman MY 05-10

## H. SPORTSMAN TANK BAG

- Easy access from driver's seat to small gear, snacks, water bottle
- Map pouch helps you stay on course

### BLACK TANK BAG

PART NO. 2875318-070

FITMENT Sportsman MY 05-10

### MOSSY OAK TANK BAG

PART NO. 2875318-419

FITMENT Sportsman MY 05-10

## I. LOCK & RIDE GUN SCABBARD MOUNTS

- High-impact case secures firearm over any terrain
- Lock & Ride system mounts on right or left
- Works with Cargo Box, Cargo Bag, Rack Extenders

### GUN SCABBARD MOUNT, RIGHT SIDE

PART NO. 2876276

FITMENT Sportsman MY 05-10

PART NO. 2876416

FITMENT Sportsman 300/400, Hawkeye MY 06-07

### SPORTSMAN GUN SCABBARD MOUNT, LEFT SIDE

PART NO. 2876275

FITMENT Sportsman MY 05-10

PART NO. 2875704

FITMENT Sportsman 300/400, Hawkeye MY 06-07

### SPORTSMAN XP GUN SCABBARD MOUNT

PART NO. 2877381

FITMENT Sportsman XP

### SPORTSMAN XP TOURING GUN SCABBARD MOUNT (Fall availability)

PART NO. 2878001

FITMENT Sportsman XP Touring

**NEW**  
2010

### SPORTSMAN TOURING GUN SCABBARD MOUNT

PART NO. 2876493

FITMENT Sportsman Touring MY 08-10 500/800

### SPORTSMAN X2 GUN SCABBARD MOUNT

PART NO. 2875783

FITMENT Sportsman X2 500/550/800/850

## G. SPORTSMAN FENDER BAG

- Convenient storage for food and gear
- Large zippered compartment
- Two pouches for water bottles

### BLACK FENDER BAG

PART NO. 2875306-070

FITMENT All models

### MOSSY OAK FENDER BAG

PART NO. 2875306-419

FITMENT All models

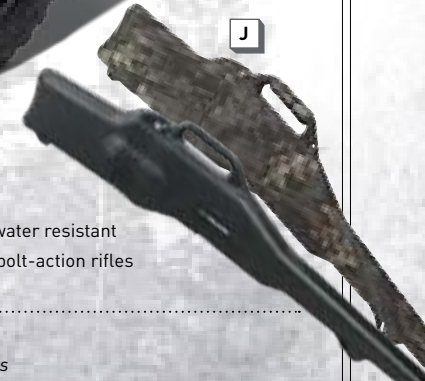

## J. KOLPIN® GUN SCABBARD

- Designed to attach to Polaris ATVs
- Features padded interior, dust proof, water resistant
- Accommodates shotguns, right-hand bolt-action rifles

### BLACK KOLPIN™ GUN SCABBARD

PART NO. 2872677

FITMENT All Polaris Gun Scabbard Mounts

### MOSSY OAK KOLPIN™ GUN SCABBARD

PART NO. 2872677-419

FITMENT All Polaris Gun Scabbard Mounts



# STORAGE

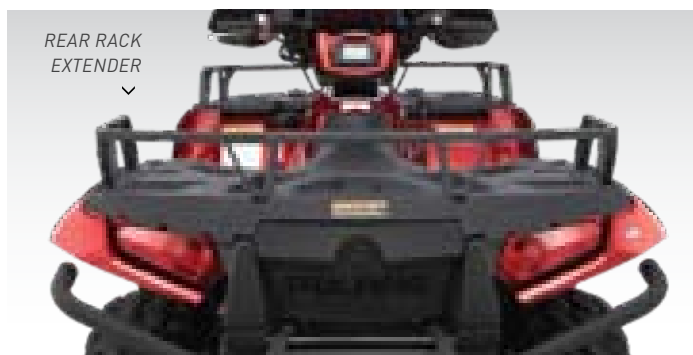

## A. SPORTSMAN XP COMPOSITE RACK EXTENDERS

- Strap your gear down to this 11 cm tall rack extender
- Tough, injection-molded nylon and glass construction
- Works with XP Cargo Box and Gun Scabbard Mount

### FRONT RACK EXTENDER

PART NO. 2876598

FITMENT Sportsman XP

### REAR RACK EXTENDER

PART NO. 2876599

FITMENT Sportsman XP

## B. SPORTSMAN XP STEEL RACK EXTENDERS

- Strap your gear down to this 11 cm tall rack extender
- Tough, steel construction
- Works with XP Cargo Box and Gun Scabbard Mount

**NEW**  
2010

### FRONT RACK EXTENDER

PART NO. 2877573

FITMENT Sportsman XP

### REAR RACK EXTENDER

PART NO. 2877574

FITMENT Sportsman XP

## C. SPORTSMAN RACK EXTENDERS

- Perfect for securing gear bags while you ride
- Made of powder-coated steel, 11 cm tall
- Works with Sportsman Cargo Box, Gun Scabbard Mount

### FRONT RACK EXTENDER

PART NO. 2875217-418

FITMENT MY 05-10 Sportsman

### REAR RACK EXTENDER

PART NO. 2875216-418

FITMENT MY 05-10 Sportsman

## D. TOURING REAR RACK EXTENDER

- Designed specifically for the Sportsman Touring
- Adds extra tie-down points for cargo

PART NO. 2876486-418

FITMENT Sportsman Touring 500/600

## E. FRONT & REAR RACK EXTENDERS

- Creates tie-down points for securing gear
- Works with soft bags and Rear Cargo Box
- Easy installation, scratch-resistant finish

### FRONT RACK EXTENDER

PART NO. 2876094-418

FITMENT Sportsman 300/400, Hawkeye

### REAR RACK EXTENDER

PART NO. 2876095-418

FITMENT Sportsman 300/400, Hawkeye



## STORAGE



A

### A. REAR CARGO RACK BASKET

- Holds big and bulky cargo
- Heavy-duty construction, powder-coat finish

15 CM TALL - REAR CARGO RACK BASKET

PART NO. 2873397

FITMENT Sportsman MY 05-10 (Requires 2875371)

### LOCK & RIDE® STEEL BASKET MOUNT

PART NO. 2875371

FITMENT Sportsman MY 05-10



B

### B. SPORTSMAN LOCK & RIDE® STEEL COMPARTMENT RACK

- Compartmentalized for gas can, tool box, bags
- Works with Lock & Ride® Backrest #2875549

PART NO. 2875547-418

FITMENT Sportsman MY 05-10

### C. LOCK & RIDE® SPORTSMAN 19 L BUCKET HOLDER

- Perfect for carrying ice fishing gear or landscaping material
- Installs quickly and easily with no tools

PART NO. 2876495

FITMENT Sportsman MY 05-10



C

### D. LOCK & RIDE® CHAINSAW/WORK BOX

- Separate compartments for saw, oil and axe
- Works with gun scabbard, ideal for building tree stands

PART NO. 2875758

FITMENT Sportsman MY 05-10



D

### E. LOCK & RIDE® BACKREST

- Adds back support and riding comfort
- Fits with Lock & Ride® Gun Scabbard Mount, Rack Extenders

PART NO. 2876616

FITMENT Sportsman XP

### F. SPORTSMAN LOCK & RIDE® BACKREST

- Locks in place in seconds
- Fully adjustable for all-day comfort
- Fits with Lock & Ride® Gun Scabbard Mount, Rack Extenders

PART NO. 2876368

FITMENT Sportsman MY 05-10



F



E

## MOWERS

>>>  
**CUT MOWING TIME.** Mounted behind or in front of your Polaris ATV, a quality Pure Polaris mower greatly reduces mowing time and leaves your property looking great. Some models cut stems up to 5 cm in diameter. All feature powerful Briggs & Stratton® engines.



G

### G. 112 CM TRAIL MOWER - ROUGH CUT

- 10.5 hp Briggs & Stratton® engine
- Recoil Start with on/off switch
- Centrifugal clutch with single blade
- Gray texture powder-coat paint

PART NO. 2878012

**NEW**  
2010

### H. 112 CM TRAIL MOWER - ROUGH CUT

- 14.5 hp Briggs & Stratton engine, recoil start
- Cuts most stems up to 5 cm in diameter
- Remote blade engage
- Safe single-point height adjustment

PART NO. 2856672



H-J

### I. 112 CM TRAIL MOWER - ROUGH CUT

- 12.5 hp I/C Briggs & Stratton® engine
- Cuts most stems up to 5 cm in diameter
- Remote blade engage
- Recoil start, battery not included

PART NO. 2856671

### J. 132 CM TRAIL MOWER - ROUGH CUT

- 18.5 hp Briggs & Stratton® engine
- Cuts most stems up to 5 cm in diameter
- Remote blade engage
- Electric start, battery not included

PART NO. 2856673



K

### K. 112 CM TRAIL MOWER - FINISH CUT

- 11.5 hp I/C Briggs & Stratton® engine, recoil start
- Rear discharge and key presence lock-cut system
- Easy tool-less adjustments

PART NO. 2856668



# CUSTOM

**MAKE IT YOUR OWN.** Dune riders need whip flags. Ice fishermen want hand warmers. Customizers gotta have some billet. Everybody needs a license plate kit. Pure Polaris custom accessories help you add all the little extras to your Polaris ATV to match the exact needs of you and your passenger.

## A. BLUE XENON HEADLIGHT BULBS

- Over 50% brighter than stock bulbs
- 98% xenon gas, 12 volt, 50 watt

PART NO. 2876464

FITMENT Sportsman MY 05-10, Sportsman XP



## B. QUARTZ HALOGEN HEADLIGHT BULB

- Replacement bulb for Sportsman ATV

PART NO. 2870448

FITMENT Sportsman MY 05-10, Sportsman XP



## C. SPORTSMAN WORKLIGHT KIT

- Lights up area behind ATV
- Great for plowing and working in reverse

PART NO. 2876090

FITMENT Sportsman MY 05-08



## D. HAND WARMERS

- Keeps both hands warm while riding
- Complete kit includes all wiring

PART NO. 2877363

FITMENT Sportsman XP, Sportsman Trail Boss, Trail Blazer, Scrambler



## E. THROTTLE/THUMB WARMERS

- Keeps throttle thumb warm
- Complete kit with all wiring

PART NO. 2877364

FITMENT Sportsman XP, Sportsman, Trail Boss, Trail Blazer, Scrambler

## F. HANDLEBAR MOUNTED MIRROR

- For added safety on or off the trail

PART NO. 2877222

FITMENT All ATVs

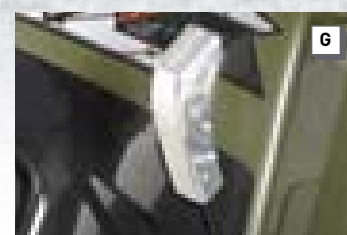

## G. BILLET SHIFTER

- Adds a custom look to your Sportsman

PART NO. 2877613

FITMENT All Sportsman MY 05-10, Sportsman XP



## H. BILLET GAS CAP

- Adds a custom touch to the top of your tank

PART NO. 2876923

FITMENT All Sportsman, Sportsman XP

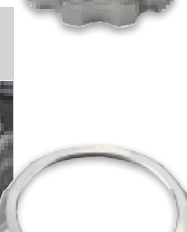
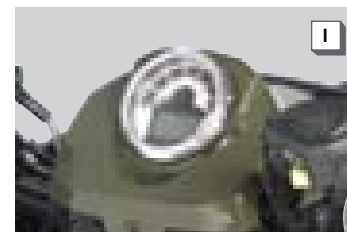

## I. BILLET SPEEDO BEZEL

- Surrounds your speedo with billet bling

PART NO. 2877415

FITMENT Sportsman MY 05-10 (except XP, 300/400)

## J. LICENSE PLATE KIT

- Everything you need to create an ATV license

PART NO. 2873270

FITMENT All ATVs



## K. 7.6 CM PASSENGER FOOT RISERS

- Raises passenger foot rests up 7.6 cm
- Adds comfort for shorter passengers
- Tough plastic, with non-slip surface

## 7.6 CM PASSENGER FOOT RISERS

PART NO. 2875782

FITMENT MY 06-09 Sportsman X2, MY 08-10 Touring 500/800

PART NO. 2877919

FITMENT MY 10 Sportsman XP, Touring, & X2



## 18 CM PASSENGER FOOT RISERS

PART NO. 2876885

FITMENT MY 06-09 Sportsman X2, MY 08-10 Touring 500/800

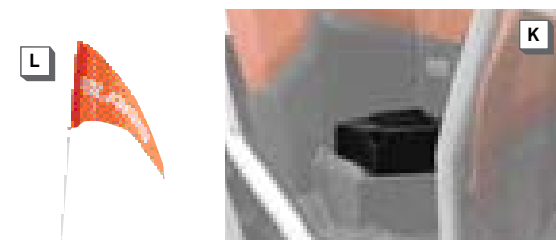

## L. WHIP FLAG

- Maximizes visibility on hilly terrain
- Required by law in many areas
- Two-piece kit: 2.4 m whip and bright flag

PART NO. 2870799

FITMENT Sportsman X2 (Requires WORS Flag Mount 2875885), Sportsman XP, Sportsman



- WINCHES PG. 116 - 117
- PLOWS PG. 118 - 123
- TRACKS PG. 124 - 125
- RIMS & TIRES PG. 126 - 129
- WINDSHIELDS PG. 130 - 131
- PROTECTION PG. 132 - 135
- STORAGE PG. 136 - 144
- MOWERS PG. 145
- CUSTOM PG. 146 - 147
- TRAILERING PG. 148 - 149
- ENTRY PG. 150 - 151
- FIT CHARTS PG. 190 - 203

# TRAILERING

**WORK EASIER.** Getting there is half the fun, especially when you put Pure Polaris accessories to work. Everything you need is right here, for loading your ATVs onto trucks and trailers, strapping them down and protecting them in transit.

## A. FOLDING HEAVY-DUTY ALUMINUM ARCHED RAMP

- Folds up for transport
- Strong enough to hold up to 680 kg.
- Includes safety straps and instructions
- Sold as pair

PART NO. 2875387

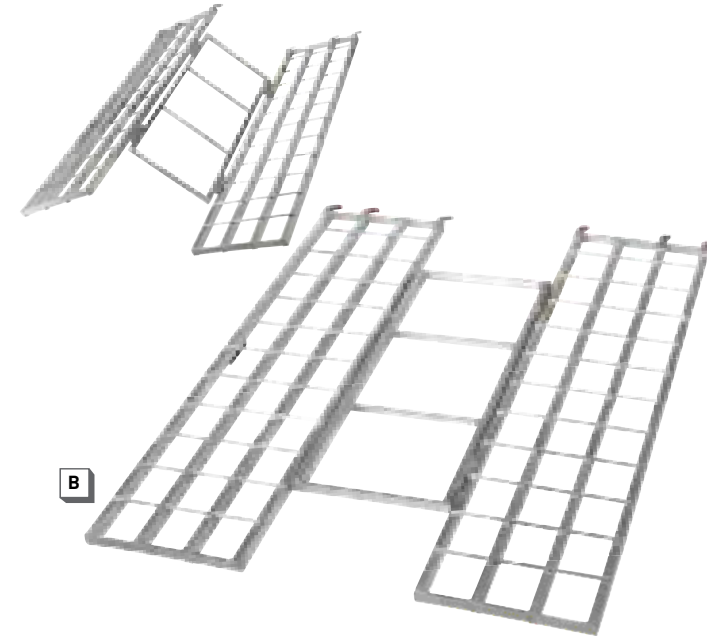
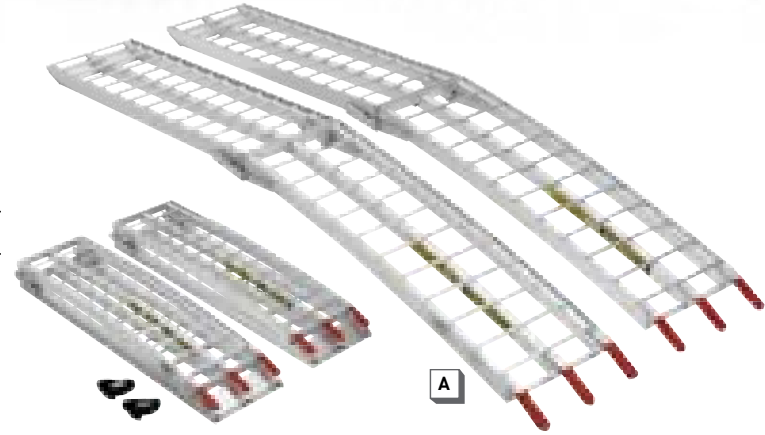

## B. LIGHTWEIGHT TRI-FOLD RAMPS

- Handles up to 680 kg.
- Folds up to fit under ATV during transport
- Includes safety straps and instructions

75 CM X 130 CM LIGHTWEIGHT TRI-FOLD RAMPS

PART NO. 2875385

85 CM X 130 CM LIGHTWEIGHT TRI-FOLD RAMPS

PART NO. 2875860

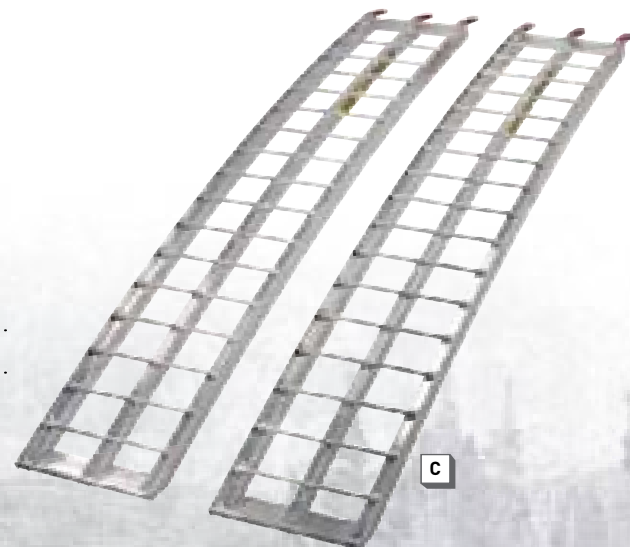

## C. ALUMINUM ARCHED LOADING RAMP

- Each ramp measures 193 cm x 30.5 cm
- Combined capacity up to 907 kg.
- Easily transportable
- Sold as pair

PART NO. 2875384



## D. DROP RECEIVER HITCH DRAW BAR

- Fits 3.2 cm receiver
- Accepts trailer balls with 1.9 cm shank

2.5 CM DROP RECEIVER HITCH DRAW BAR

PART NO. 2877476

7.6 CM DROP RECEIVER HITCH DRAW BAR

PART NO. 2873365

## E. TRAILER BALL & SHANK

4.8 CM TRAILER BALL, 1.9 CM SHANK

PART NO. 2877602

5 CM TRAILER BALL, 1.9 CM SHANK

PART NO. 2877603

## F. DROP RECEIVER HITCH DRAW BAR

- Locks draw bar to ATV

PART NO. 2873364

## G. STRAPS

1.5 M BLACK TIE DOWN STRAPS

PART NO. 2871181

QUANTITY Pair

1.5 M BLACK TIE DOWN STRAPS

PART NO. 2871182

QUANTITY Pair

BLACK RATCHET STRAPS

PART NO. 2859047-02

QUANTITY Pair

RED RATCHET STRAPS

PART NO. 2859047-01

QUANTITY Pair

## H. SPORTSMAN COVERS

- Provides protection during transport and storage
- Rugged 600 denier polyester, won't flap in wind
- Breathable polyurethane coating

PART NO. 2876614

FITMENT All Sportsman (except 300/400, X2, Touring)

PART NO. 2877998

FITMENT All Sportsman Touring

PART NO. 2877999

FITMENT Sportsman X2

PART NO. 2875718

FITMENT Sportsman 300/400, Hawkeye



- WINCHES PG. 116 - 117
- PLOWS PG. 118 - 123
- TRACKS PG. 124 - 125
- RIMS & TIRES PG. 126 - 129
- WINDSHIELDS PG. 130 - 131
- PROTECTION PG. 132 - 135
- STORAGE PG. 136 - 144
- MOWERS PG. 145
- CUSTOM PG. 146 - 147
- TRAILERING PG. 148 - 149
- ENTRY PG. 150 - 151
- FIT CHARTS PG. 190 - 203



# ENTRY

>>>

**EVERYTHING YOU NEED.** Our Entry line includes the Trail Boss 330, Trail Blazer 330 and Scrambler 500 4x4, all very popular ATVs. Rest assured, we put the same kind of quality, reliability and long-lasting durability into the all new Pure Polaris accessories for these vehicles as we do for the accessories we build for the Polaris Sportsman. No matter what Polaris ATV you own, we want you to get the most out of every off-road adventure, whether it's for working, hunting or riding the trails.

**NEW  
2010**

## A. POLARIS 680 KG WINCH

- A compact winch that fits our mid-size ATVs
- Hard-working 1,500-lb. rated pull
- Handlebar-mounted rocker switch
- Roller fairlead for smooth operation

PART NO. 2877976

FITMENT MY10 Trail Blazer, Scrambler

\* Fall Availability

## B. LOCK & RIDE® WINDSHIELD

- Protects driver from dust and wind
- Easy installation

PART NO. 2875682

FITMENT MY10 Trail Boss, Trail Blazer, Scrambler

## C. HANDLE BAR MOUNTED MIRROR

- For added safety on or off the trail

PART NO. 2877222

FITMENT MY10 Trail Boss, Trail Blazer, Scrambler



## D. HAND GUARDS

- Protects driver's hands from branches and cold
- Made of strong, high-density polyethylene

PART NO. 2874871-177

FITMENT MY10 Trail Boss, Trail Blazer, Scrambler

## E. REAR RACK

- Creates a platform for securing gear
- Easy installation
- Add Rear Rack Extender for additional height

PART NO. 2878002

FITMENT MY10 Trail Blazer, Scrambler

## F. REAR RACK EXTENDER

- Perfect for securing bags while you ride
- Easy installation
- Made of powder-coated steel

PART NO. 2877745

FITMENT MY10 Trail Boss, Trail Blazer, Scrambler

## G. REAR CARGO BOX

- Large capacity to hold gear and tools
- Heavy-duty construction
- Easy installation

PART NO. 2875678

FITMENT MY10 Trail Boss, Trail Blazer, Scrambler



^ TRAIL BOSS



## G. FRONT SOFT BAG

- Large capacity to hold gear and tools
- Heavy-duty construction
- Easy installation

PART NO. 2875651

FITMENT MY10 Trail Boss



## H. FRONT RACK EXTENDER

- Creates tie-down points to secure your gear
- Easy installation, scratch resistant finish

PART NO. 2877746

FITMENT MY10 Trail Boss

## I. TOW HITCH

- Will accept trailer balls with 1.9 cm shank

PART NO. 2873036

FITMENT MY10 Trail Blazer, Scrambler

## J. THUMB WARMER

- Keeps throttle thumb warm
- Easy installation

PART NO. 2877364

FITMENT MY10 Trail Boss, Trail Blazer, Scrambler

## K. HAND WARMERS

- Keeps hands warm while riding

PART NO. 2877363

FITMENT MY10 Trail Boss, Trail Blazer, Scrambler



^ SCRAMBLER

WINCHES  
PG. 116 - 117

PLOWS  
PG. 118 - 123

TRACKS  
PG. 124 - 125

RIMS & TIRES  
PG. 126 - 129

WINDSHIELDS  
PG. 130 - 131

PROTECTION  
PG. 132 - 135

STORAGE  
PG. 136 - 144

MOWERS  
PG. 145

CUSTOM  
PG. 146 - 147

TRAILERING  
PG. 148 - 149

ENTRY  
PG. 150 - 151

FIT CHARTS  
PG. 190 - 203

EXHAUST / PERF  
PG. 154 - 155

CUSTOM  
PG. 154 - 155

SHOCKS  
PG. 154 - 155

SHOCK COVERS  
PG. 154 - 155

COVERS  
PG. 154 - 155

PROTECTION  
PG. 156 - 157

BUMPERS / GUARDS  
PG. 156 - 157



**JAWS DROP** at the Outlaw's race-winning power and handling. And when the trophies are handed out, cameras click to capture its intimidating, customized look. Pure Polaris has everything you need to take your stock Outlaw to the next level and track down the competition.



# CUSTOM

>>>

**PURE PERFORMANCE.** Pure Polaris performance accessories are designed to customize your Polaris sport quad, making your Outlaw even meaner or giving your Predator more teeth. There are pipes, bars, wheel kits, covers and more, all built to help you dominate on the track or trail.

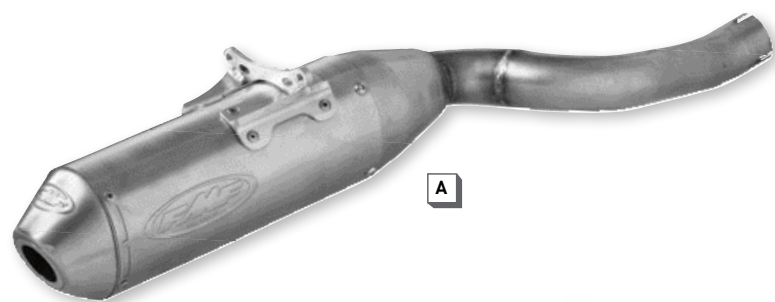

## A. OUTLAW 525 IRS FMF® + OUTLAW 525 S/450 MXR FMF® PERFORMANCE SILENCER

Provides a boost in performance across the RPM range. Made of stainless steel and 2 kg lighter than stock exhaust. Use with stock header pipe, no rejetting required. Includes removable spark arrestor.

PART No. 2876741

FITMENT Outlaw 525 IRS MY 07-10

PART No. 2876867

FITMENT Outlaw 525 S / 450 MXR MY 08-10



## B. OUTLAW 500 PERFORMANCE E2 SILENCER

This premium silencer for Outlaw boosts torque and horsepower with a lightweight, aircraft-grade twin canister. Designed by White Brothers.

■ USFS approved

PART No. 2875940

FITMENT Outlaw 500

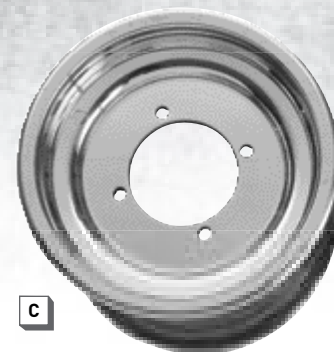

## C. OUTLAW REAR WHEEL KIT

Wheel kit specifications match those of stock wheels for installation of dune or dirt tires.

Sold as a pair.

PART No. 2876078 (Sold as pair)

FITMENT Outlaw 500 / 525 IRS



## D. PREDATOR FRONT SHOCK COVERS

PART No. 2875966 (Sold as pair)

FITMENT Predator

## E. PREDATOR REAR SHOCK COVERS

PART No. 2875967 (Sold individually)

FITMENT Predator



## G. FOX® REMOTE RESERVOIR

Increases cooling capacity, reduces shock fade and adds compression adjustment to stock front shocks.

PART No. 2874244

FITMENT All models with Fox® shocks



## H. OUTLAW SHOCK COVERS

Outlaw's "smoking guns" logo matches Outlaw's aggressive look. Sold as a pair.

PART No. 2875968

fitment Outlaw



## F. OUTLAW GRIPPER SEAT

Gripper seat covers help riders stay put in extreme terrain.

PART No. 2876863

FITMENT Outlaw MY 06-08



## I. POLARIS SHOCK COVERS

The eye-catching flame graphic design fits Outlaw and Predator. Front sold as pair. Rear sold individually.

PART No. 2875970 (Front)

FITMENT Predator, Outlaw

PART No. 2875971 (Rear)

FITMENT Predator, Outlaw

## J. TRAILERABLE ATV COVERS

A customized cover designed to fit perfectly and add protection during storage.

- Water-resistant weather protection
- Zippered fuel fill opening
- Customized with Outlaw Performance, Predator Performance, or Polaris logo

### OUTLAW TRAILERABLE ATV COVER

PART No. 2876866 | Black

FITMENT Outlaw

### PREDATOR TRAILERABLE ATV COVER

PART No. 2874191 | Black

FITMENT Predator



EXHAUST / PERF  
PG. 154 - 155

CUSTOM  
PG. 154 - 155

SHOCKS  
PG. 154 - 155

SHOCK COVERS  
PG. 154 - 155

COVERS  
PG. 154 - 155

PROTECTION  
PG. 156 - 157

POLARIS  
2010 ATV PERF

# PROTECTION

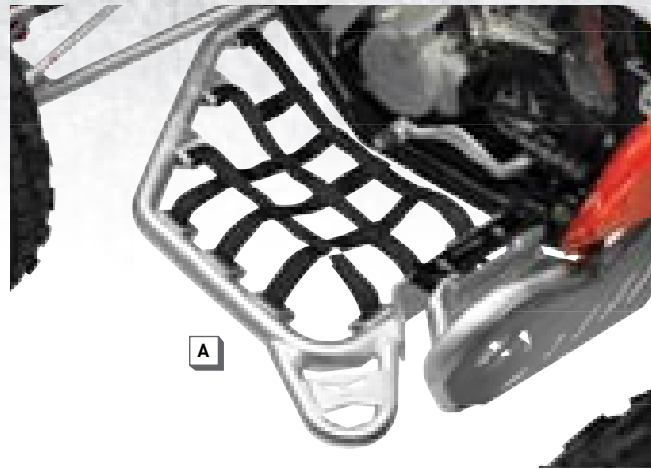

## A. NERF BARS

Designed to provide added protection and safety. Made of 3.2 cm brushed aluminum tubing, rugged steel mounting plates, and replaceable and adjustable nylon netting.

- Integrated mounting points for installation
- Webbing stays inside nerf bar for extra protection

PART No. 2876843

FITMENT All Outlaw

PART No. 2877211 | REPLACEMENT WEBBING

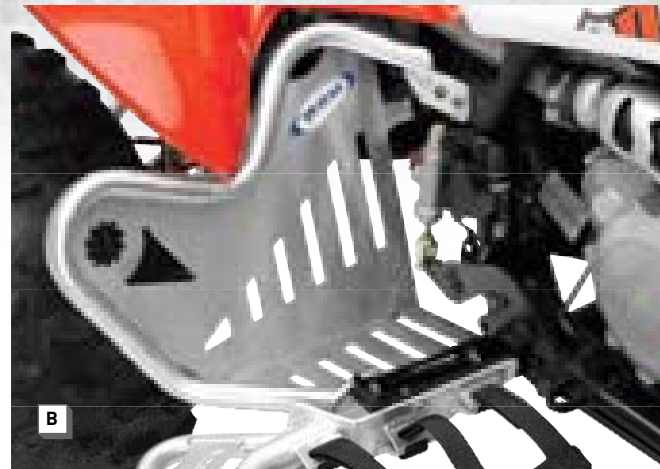

## B. OUTLAW HEEL POCKETS

Rugged aluminum construction for a solid stance and added protection. Gives aggressive riders the edge for superior overall handling. Built from rugged 2.5 cm x 0.3 cm wall aluminum tubing.

PART No. 2877598

FITMENT Outlaw MY 09-10

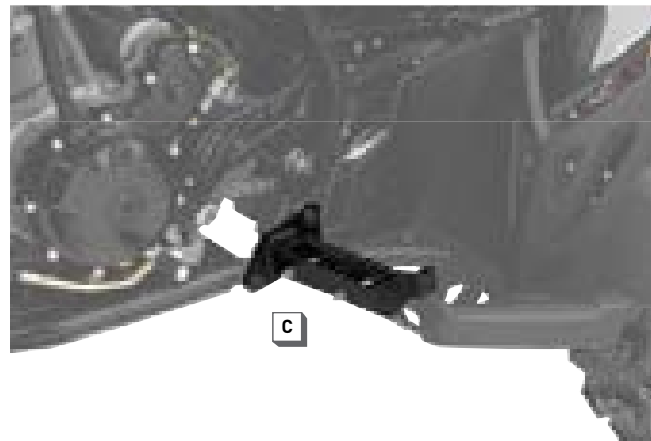

## C. FOOT PEG EXTENSIONS

For added foot traction and safety when riding the Outlaw or Predator. Bolts on to existing foot peg.

PART No. 2875433

FITMENT Predator, Outlaw

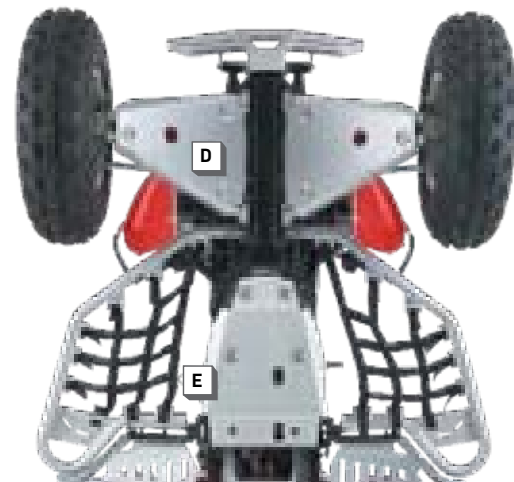

## D. ALUMINUM A-ARM GUARDS

Made from 0.3 cm aluminum with a line grain brush finish and attaches to the A-arm using billet hooks.

PART No. 2877601

FITMENT All Outlaw

## E. ALUMINUM SKID PLATE

Made from 0.5 cm aluminum with a line grain brush finish and attaches using existing mounting points and billet hooks.

PART No. 2877600

FITMENT All Outlaw S/MXR

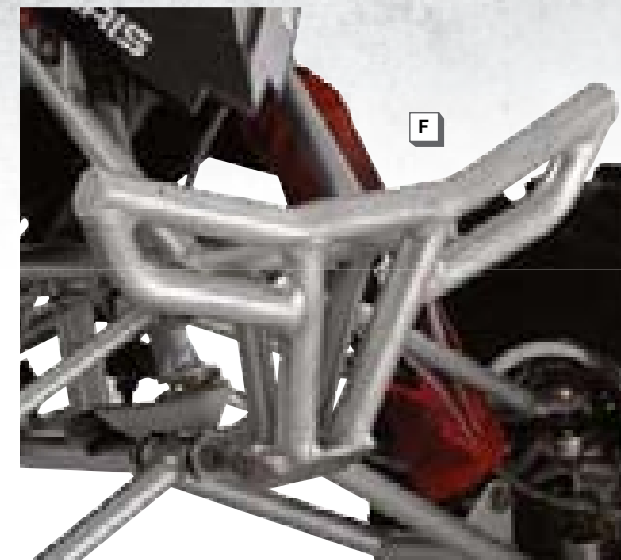

## F. OUTLAW FRONT GRAB BAR

With an integrated approach to protection and performance, the Outlaw grab bar fits seamlessly with the Outlaw's skid plate for hardy front end protection and an aggressive custom look.

- 2.5 cm brushed aluminum tubing

PART No. 2876356

FITMENT Outlaw



## G. OUTLAW REAR GRAB BAR

Designed exclusively for Outlaw IRS and Outlaw S models, featuring rugged construction from 3.2 cm x 0.3 cm aluminum tube. Mounts to stock rear grab bar location with a mounting location for whip flag.

PART No. 2876157

fitment Outlaw



## H. PREDATOR FRONT GRAB BAR

Performance-oriented grab bar protects the Predator's front end while adding a custom look. Its design follows fender lines and integrates seamlessly with the skid plate for greater protection.

- Heavy-duty, 2.5 cm brushed aluminum tubing

PART No. 2874211

FITMENT Predator

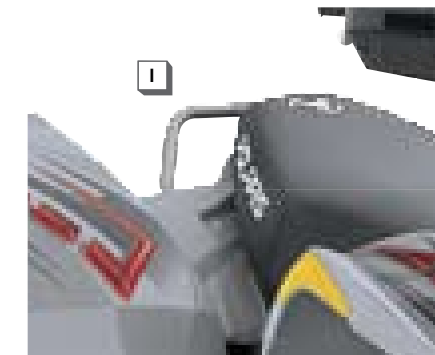

## I. PREDATOR REAR GRAB BAR

Featuring a mounting tab for a dune flag, the Rear Grab Bar gives the Predator a sleek, finished look when paired with the Front Grab Bar #2874211.

- Lightweight, easy to grab, 2.5 cm brushed aluminum

PART No. 2874210

FITMENT Predator



## J. PREDATOR RACING FRONT BUMPER

This tough, lightweight bumper is designed to integrate with the front-end and skid plate for seamless protection and minimum drag.

- Made of brushed aluminum tubing

PART No. 2874981

FITMENT Predator





- HELMETS  
PG. 160 - 165
- GOGGLES  
PG. 165
- GLOVES / PROTECTION  
PG. 166 - 167
- MEN'S JACKETS  
PG. 168 - 171
- WOMEN'S JACKETS  
PG. 172 - 173
- PANTS / BOOTS  
PG. 174 - 175
- MEN'S CASUAL  
PG. 176 - 177
- WOMEN'S CASUAL  
PG. 178 - 179
- CAPS / BEANIES  
PG. 180
- GEAR BAGS  
PG. 181
- COLLECTIBLES  
PG. 181
- FIT CHARTS  
PG. 181



**COMFORT, STYLE AND PROTECTION.** At the track or on the trail, Pure Polaris apparel is designed for the ultimate in comfort, style and protection. Whether you're a racing pro or a weekend warrior, we've got you covered with an extensive line of premium quality helmets, goggles, gloves, jackets, pants, base layers, t-shirts and ballcaps.



# HELMETS

**QUALITY. COMFORT. STYLE.** No two riders are exactly alike, which is why we build such a wide variety of helmets. Every quality Polaris helmet is designed for riders by riders. Wear a Polaris helmet and you're assured of the ultimate in protection and comfort in your most important piece of gear.



## HELMET TECHNOLOGY



Pure Polaris helmets offer exceptional quality, comfort and fit. They are lightweight and provide maximum impact protection, plus superior visibility and ventilation. Many models feature quick-adjust straps, convenient washable liners and other features riders appreciate when riding off-road.

### A. DEMON HELMET

A composite fiberglass shell gives this helmet superior, lightweight comfort. In fact, it's the lightest helmet in our line, with all the "must-have" moto features.

- **Shell:** Lightweight, composite fiberglass with dual density EPS liner
- **Vents:** Aerodynamic, vented cover, flow-through ventilation system
- **Interior:** Fully removable, washable Dupont Coolmax® liner
- **Safety:** Snell/DOT approved
- **Additional Feature:** Adjustable visor, goggle holder compatible with most goggle brands, adjustable chin strap, removable molded roost deflector, integrated nose guard

PART NO. 2869323 | RED MATTE | S-3XL

PART NO. 2869324 | SILVER MATTE | S-3XL

PART NO. 2869479 | REPLACEMENT VISOR | RED

PART NO. 2869480 | REPLACEMENT VISOR | SILVER

PART NO. 2869484 | VISOR SCREW KIT

### B. TENACITY HELMET **NEW 2010**

Designed for the recreational trail rider, this top-selling helmet offers safety & performance.

- **Shell:** Polycarbonate
- **Vents:** Mouth vent, chin vents, eyebrow vents, 6 exhaust vents
- **Interior:** Breathable, moisture wicking removable liner
- **Safety:** DOT/ECE approved
- **Additional Feature:** Goggle guide, adjustable visor, removable liner, padded chin straps, large eye port, nose guard, double d-ring for secure connection

PART NO. 2860146 | RED MATTE | S-2XL

PART NO. 2860144 | BLACK MATTE | S-2XL

PART NO. 2860205 | REPLACEMENT VISOR | RED MATTE

PART NO. 2860204 | REPLACEMENT VISOR | BLACK MATTE



ADULT SIZE CODES FOR ORDERING (SEE COMPLETE SIZE CODE CHARTS ON PAGE 181)

Don't forget to add the two-digit size code at the end of the part number!  
See size availability in the item description, not all sizes available in all styles.

XS - 01	M - 03	M-TALL - 05	L-SHORT - 07	XL - 09	XL-TALL - 11	2XL-TALL - 13
S - 02	M-SHORT - 04	L - 06	L-TALL - 08	XL-SHORT - 10	2XL - 12	3XL - 14



# HELMETS

## A. MOMENTUM HELMET

Designed for the recreational trail rider, this top-selling helmet offers safety & performance.

- **Shell:** Alloy polycarbonate
- **Vents:** Mouth air intake vent, forehead and rear vents
- **Interior:** Removable, washable Duralux liner.
- **Safety:** Snell M2005/DOT approved
- **Additional Feature:** Aerodynamic visor, reduces wind drag and sun glare, integrated nose guard

PART NO. 2868076 | BLUE MATTE | S-3XL

PART NO. 2868077 | PINK MATTE | S-3XL

PART NO. 2868224 | REPLACEMENT VISOR | BLUE MATTE

PART NO. 2868225 | REPLACEMENT VISOR | PINK MATTE

PART NO. 2852470 | VISOR SCREW KIT



A



B

## B. ASSAULT HELMET

Polycarbonate construction makes this helmet light and comfortable. Skull graphics make it one of the hottest lids on the trail.

- **Shell:** Alloy polycarbonate
- **Vents:** Mouth air intake vent, forehead and rear vents
- **Interior:** Removable, washable Duralux liner. Integrated nose guard
- **Safety:** Snell M2005/DOT approved
- **Additional Feature:** Aerodynamic visor, reduces glare, integrated nose guard

PART NO. 2869100 | ASSAULT RED MATTE | S-3XL

PART NO. 2860140 | REPLACEMENT VISOR | RED ASSAULT

PART NO. 2852470 | VISOR SCREW KIT



C

## D. DRAGON HELMET

In addition to outstanding comfort and protection, this helmet features the Polaris Factory-Racing orange matte color for maximum visibility when racing or trail riding.

- **Shell:** Alloy polycarbonate
- **Vents:** Mouth air intake vent, forehead and rear vents
- **Interior:** Removable, washable Duralux liner.
- **Safety:** Snell M2005/DOT approved
- **Additional Feature:** Aerodynamic visor, reduces sun glare, integrated nose guard

PART NO. 2868079 | FACTORY RACE ORANGE MATTE | S-3XL

PART NO. 2868226 | REPLACEMENT VISOR | ORANGE

PART NO. 2852470 | VISOR SCREW KIT

## C. DRAGON II HELMET NEW 2010

Dragon graphics give this helmet an aggressive look. Fully featured, it's perfect for the recreational trail rider.

- **Shell:** Polycarbonate
- **Vents:** Mouth vent, chin vents, eyebrow vents, 6 exhaust vents
- **Interior:** Breathable, moisture wicking removable liner
- **Safety:** DOT/ECE approved
- **Additional Feature:** Goggle guide, adjustable visor, removable liner, padded chin straps, large eye port, nose guard, double d-ring for secure connection

PART NO. 2860147 | WHITE MATTE | S-2XL

PART NO. 2860206 | REPLACEMENT VISOR | WHITE



D

## E. DEFENDER HELMET

The defender offers aggressive styling at an affordable price.

- **Shell:** Alloy polycarbonate
- **Vents:** Mouth air intake vent
- **Interior:** Removable, washable Duralux liner
- **Safety:** DOT approved
- **Additional Feature:** Aerodynamic visor, reduces glare

PART NO. 2869458 | SPECIAL EDITION MATTE | S-3XL

PART NO. 2868082 | RED | L-3XL

PART NO. 2868083 | BLUE | L-2XL

PART NO. 2868084 | SILVER | S-3XL

PART NO. 2868085 | BLACK | S-3XL

PART NO. 2868419 | MOSSY OAK® | S-3XL

PART NO. 2869503 | REPLACEMENT VISOR | SPECIAL ED. MATTE

PART NO. 2868229 | REPLACEMENT VISOR | RED

PART NO. 2868230 | REPLACEMENT VISOR | BLUE

PART NO. 2868231 | REPLACEMENT VISOR | SILVER

PART NO. 2868233 | REPLACEMENT VISOR | BLACK

PART NO. 2852470 | VISOR SCREW KIT



E



Available in Mossy Oak® Camo break-up for you avid hunters.



ADULT SIZE CODES FOR ORDERING (SEE COMPLETE SIZE CODE CHARTS ON PAGE 181)

Don't forget to add the two-digit size code at the end of the part number! See size availability in the item description, not all sizes available in all styles.

XS = 01	M = 03	M-TALL = 05	L-SHORT = 07	XL = 09	XL-TALL = 11	2XL-TALL = 13
S = 02	M-SHORT = 04	L = 06	L-TALL = 08	XL-SHORT = 10	2XL = 12	3XL = 14



# HELMETS



## A. PURSUIT HELMET

Stylish and dependable, the Pursuit is a favorite among sport riders.

- **Shell:** ABS thermo injected shell
- **Vents:** Mouth air intake vent, forehead and rear vents
- **Interior:** Removable, washable liner
- **Safety:** DOT approved
- **Additional Feature:** Aerodynamic visor, reduces sun glare

PART NO. 2869338 | RED | S-2XL

PART NO. 2869339 | BLUE | M-2XL

PART NO. 2869340 | SILVER | S-2XL

PART NO. 2869341 | BLACK | S-2XL

PART NO. 2869342 | PINK | S-2XL

PART NO. 2869472 | REPLACEMENT VISOR | RED

PART NO. 2869473 | REPLACEMENT VISOR | BLUE

PART NO. 2869474 | REPLACEMENT VISOR | SILVER

PART NO. 2869475 | REPLACEMENT VISOR | BLACK

PART NO. 2869483 | REPLACEMENT VISOR | PINK



## B. KTP HELMET

The absolute best value in ATV helmets, our unique, multi-purpose KTP features a face shield that slides up and down. It even works with goggles in the up position.

- **Shell:** ABS thermo injected shell
- **Vents:** Air-intake, flow-through ventilation system
- **Interior:** Fully removable, washable liner
- **Safety:** ECE/DOT approved
- **Additional Feature:** Adjustable visor, adjustable chin strap, movable polycarbonate eye shield replaces need for goggles

PART NO. 2869364 | BLACK | S-2XL

PART NO. 2869502 | REPLACEMENT VISOR | BLACK



## HELMET TECHNOLOGY >

The KTP Helmet shield moves down for riding, up for trail breaks without removing helmet. Flow-thru ventilation provides all-day comfort in any weather.

Shield in up position



Shield in down position



## C. YOUTH MX HELMET

A must have for every youth moto head.

- **Shell:** ABS thermo injected shell
- **Vents:** Mouth vent and eye port
- **Interior:** Removable, washable liner, integrated nose guard
- **Safety:** DOT/ECE approved

PART NO. 2860174 | BLACK | YOUTH S-L



## D. YOUTH MX GOGGLE

Sized for young riders, with adjustable strap for a snug fit.

- Hypoallergenic face foam
- Clear Lexan® lens

PART NO. 2869278



## E. SMITH® VSN SINGLE LENS GOGGLE

Industry-leading Smith® Optics outstanding off-road eye protection.

- Articulating Outrigger Positioning System for superior helmet compatibility
- In-lens Tear Offs posts
- Extended F.A.T. 2-layer face foam to seal out cold spots
- Dual pane, yellow anti-fog Lexan® lens
- Ultra-wide silicone backed strap

PART NO. 2868413 | VSN | BLACK

PART NO. 2868414 | VSN | SILVER

PART NO. 2868415 | VSN SINGLE LENS REPLACEMENT | CLEAR

PART NO. 2868416 | VSN SINGLE LENS REPLACEMENT | YELLOW

PART NO. 2868417 | VSN SINGLE LENS REPLACEMENT | BLUE

PART NO. 2868418 | VSN SINGLE LENS TEAROFF

PART NO. 2855432 | QUICK RELEASE GOGGLE STRAP

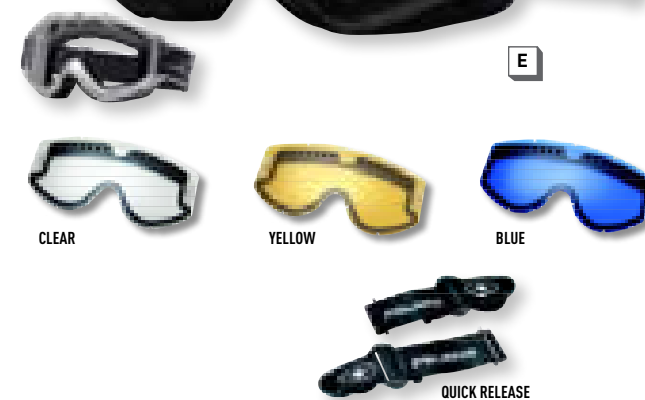

## F. SPYDER FX® HELMET CAM

The ultimate in helmet-cam technology.

- Complete video recording system with camera and Mini-DVR
- Attaches to any helmet or visor
- 640 x 480 resolution video at 30 FPS
- Up to 3 hours of recording time
- Mini-DVR housed in rugged, waterproof casing
- 3-hour, rechargeable Li-Ion battery
- 1-year factory warranty

PART NO. 2859555



# GLOVES & PROTECTION

>>>

**PLAY IT SAFE.** It's rough out there. On the track and the trail, protect yourself with quality Pure Polaris riding gear. Choose your favorite gloves, then slip on some knee/shin guards and a chest protector or safety jacket. Now get out there and ride.



## A. RACING GLOVES

Designed for riders that are looking for the perfect combination of coverage and flexibility.

- **Shell:** Stretch nylon
- **Palm:** Clarino® palm material
- **Safety:** CE approved
- **Additional Feature:** Reinforced palm, precurved fingers, Velcro® wrist closure

PART NO. 2869247 | RED | XS-3XL

PART NO. 2869246 | BLACK | XS-3XL

PART NO. 2869248 | BLUE | S-3XL

PART NO. 2869250 | PINK | XS-L



## B. POLARIS CHEST PROTECTOR

- Injection molded PVC protection
- Adjustable strap system for perfect fit
- CE approved
- Includes EVA foam in the torso and shoulders for increased comfort. Plating is channeled for increased airflow while riding

PART NO. 2869258 | ONE SIZE

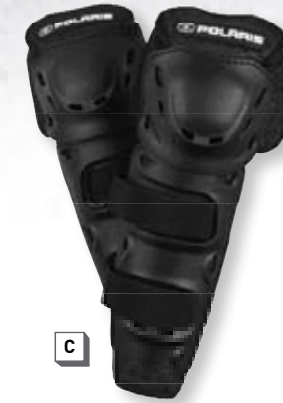

## C. POLARIS SHIN GUARDS

- Articulated knee
- Flexible knee cup
- Secures to leg with adjustable Velcro® strap
- Coolmax® interior wicks perspiration

PART NO. 2869261 | BLACK | ONE SIZE



## D. POLARIS SAFETY JACKET

- Unrestricted, full torso and back protection
- Injection-molded plastic spine
- Open weave stretch fabric
- Vented chest plate for exceptional airflow and movement
- Molded shoulder and elbow cups conform for a personalized fit
- Includes: adjustable kidney belt
- CE Approved

PART NO. 2869260 | M-XL



## E. CARBON KNUCKLE GLOVES

- **Shell:** Neoprene
- **Palm:** Clarino® palm material
- **Safety:** CE approved
- **Additional Feature:** Molded carbon knuckle, reinforced palm, Kevlar® reinforcements in high-wear areas. Molded vents for superior breathability, Velcro® wrist closure

PART NO. 2869254 | BLACK | S-3XL



## F. POWERSLIDE GLOVES

- **Shell:** Stretch nylon
- **Palm:** Clarino® palm material
- **Safety:** CE approved
- **Additional Feature:** Reinforced palm, silicone branding on fingers for additional protection, Velcro® wrist closure

PART NO. 2869243 | RED | XS-3XL

PART NO. 2869244 | BLUE | XS-3XL

PART NO. 2869242 | BLACK | XS-3XL

ADULT SIZE CODES FOR ORDERING (SEE COMPLETE SIZE CODE CHARTS ON PAGE 181)

Don't forget to add the two-digit size code at the end of the part number! See size availability in the item description, not all sizes available in all styles.

XS - 01	M - 03	M-TALL - 05	L-SHORT - 07	XL - 09	XL-TALL - 11	2XL-TALL - 13
S - 02	M-SHORT - 04	L - 06	L-TALL - 08	XL-SHORT - 10	2XL - 12	3XL - 14

HELMETS  
PG. 160 - 165

GOGGLES  
PG. 165

GLOVES / PROTECTION  
PG. 166 - 167

MEN'S JACKETS  
PG. 168 - 171

WOMEN'S JACKETS  
PG. 172 - 173

PANTS / BOOTS  
PG. 174 - 175

MEN'S CASUAL  
PG. 176 - 177

WOMEN'S CASUAL  
PG. 178 - 179

CAPS / BEANIES  
PG. 180

GEAR BAGS  
PG. 181

COLLECTIBLES  
PG. 181

FIT CHARTS  
PG. 181



# MEN'S JACKETS

**PURPOSE-BUILT FOR EXTREME TERRAIN.** To dominate on the track or trail, you need riding gear as purpose-built as your Polaris off-road vehicle. Start with a quality Polaris jacket. Be sure to check out the Off-Road Jacket, complete with zip-off arms for the ultimate in 3-season versatility. Choose the Polaris jacket that matches the level of protection you need and the temperatures you ride in.

## A. OFF-ROAD JACKET

Designed for off-road enthusiasts, the Off-Road Jacket offers great comfort, technical features and protection for a whole day of riding.

- **Shell:** Ballistic nylon, mesh lining
- **Windproof Breathable:** Water resistant
- **Venting:** Shoulder intake, rear vertical exhaust vents
- **Pockets:** 11 total pockets including 3 chest, 2 hand, 1 sleeve, 2 interior, 2 rear, and 1 sleeve ID
- **Additional Features:** Hydration/communication rubber port, removable sleeves that zip off and can be stored in rear cargo pocket, articulated sleeves with additional elbow padding, adjustable Velcro® waist, side zips to allow for total comfort while in a seated position, Velcro wrist adjustments

PART No. 2869255 | BLACK | MEN'S S-3XL



> Zip-off sleeves for versatility.



> ID sleeve pocket to hold valuables.



> Interior pocket perfect for your iPod®.



Pure Polaris makes it easy for ATV riders to coordinate gear perfectly to their riding style, climate and terrain. Shown here is a great combination for summer trail riding, and includes the Demon Helmet, Racing Jersey, Racing Gloves and new Transform Pant that zips off at the knees and fits over jeans and shorts.



## B. eVT JACKET

This all-weather riding jacket has the ultimate in waterproofing, breathability and comfort. Designed with off-road riders in mind, it features eVent® fabrics that breathe faster than GORE-TEX®, plus full venting and plenty of pockets.

- **Shell:** 100% nylon shell
- **Waterproof Breathable:** eVent® membrane
- **Insulation:** Non-insulated, mesh lined
- **Venting:** Full zip vents at underarm and back
- **Pockets:** Four exterior pockets, one with chamois cloth inside to wipe goggles, two interior pockets
- **Additional Features:** Waterproof two-way front zipper, zipper garages on exterior pockets create tight seal. Microfleece rollover collar for rider comfort. Dirt skirt, neck drawcord, adjustable back drawcord and wrist snaps keep dust, dirt and rain out.

PART No. 2860112 | RED / BLACK | MEN'S M-2XL (NO TALLS)

PART No. 2869030 | GRAY / CAMO | MEN'S S-2XL, MT-XLT

PART No. 2869031 | BLACK | MEN'S S-3XL, MT-XLT

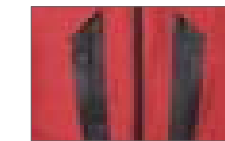
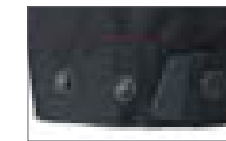
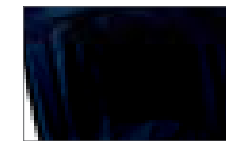

## C. OCTANE JACKET

Uninsulated and mesh lined, this ATV jacket is perfect to wear over layers in cold weather or over a shirt in warmer weather. It has a high level of waterproofing and breathability, and is 100% seam sealed. It's fully vented and has a long list of features you'll appreciate out on the trail.

- **Shell:** 100% Nylon
- **Waterproof Breathable:** Reissa® (8,000mm/8,000g)
- **Insulation:** Non-insulated, mesh lined
- **Venting:** Full zip vents at underarm and back
- **Pockets:** Four exterior pockets, one with chamois cloth inside to wipe goggles/shield, two interior pockets
- **Additional Features:** Waterproof two-way front zipper, zipper garages on exterior pockets create tight seal. Microfleece rollover collar for rider comfort. Dirt skirt, neck drawcord and adjustable back drawcord keep dirt out

PART No. 2860113 | BLACK / GRAY PLAID | MEN'S M-2XL



ADULT SIZE CODES FOR ORDERING (SEE COMPLETE SIZE CODE CHARTS ON PAGE 181)

Don't forget to add the two-digit size code at the end of the part number! See size availability in the item description, not all sizes available in all styles.

XS = 01	M = 03	M-TALL = 05	L-SHORT = 07	XL = 09	XL-TALL = 11	2XL-TALL = 13
S = 02	M-SHORT = 04	L = 06	L-TALL = 08	XL-SHORT = 10	2XL = 12	3XL = 14

\*GORE-TEX® is the registered trademark of W.L. Gore & Associates Inc.

REFERENCE FIT CHARTS ON PG. 181 BEFORE ORDERING.  
VISIT PUREPOLARIS.COM FOR MORE INFORMATION.

HELMETS  
PG. 160 - 165

GOGGLES  
PG. 165

GLOVES / PROTECTION  
PG. 166 - 167

MEN'S JACKETS  
PG. 168 - 171

WOMEN'S JACKETS  
PG. 172 - 173

PANTS / BOOTS  
PG. 174 - 175

MEN'S CASUAL  
PG. 176 - 177

WOMEN'S CASUAL  
PG. 178 - 179

CAPS / BEANIES  
PG. 180

GEAR BAGS  
PG. 181

COLLECTIBLES  
PG. 181

FIT CHARTS  
PG. 181



# MEN'S JACKETS

## THE ANATOMY OF EFFECTIVE LAYERING.

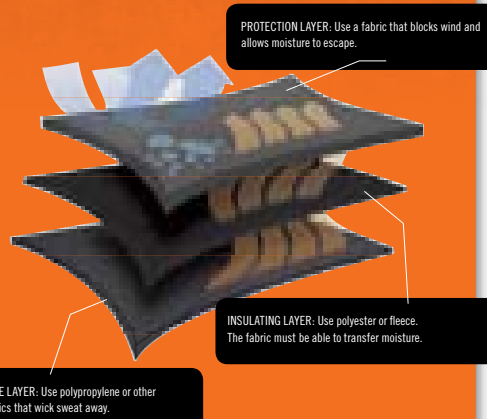

**PROTECTION LAYER:** Use a fabric that blocks wind and allows moisture to escape.

**INSULATING LAYER:** Use polyester or fleece. The fabric must be able to transfer moisture.

**BASE LAYER:** Use polypropylene or other fabrics that wick sweat away.

There is no perfect layering system. Every rider has different needs, depending on weather, altitude, riding style and body type. But there are basic rules for layering. The base layer needs to wick sweat away from your skin. Polypropylene is good, cotton is bad. The insulating layer must work with the base layer to transfer moisture. Polyester and fleece are best. A good outer layer must block wind and also allow moisture to escape. Add or remove layers as needed to stay warm and comfortable.



### STEP 1

- Base Layer
- Performance Shirt
- Polypropylene Thermal Shirt
- Polypropylene Pant



### STEP 2

- Insulating Layer
- Backcountry Riding Shirt
- Quarter-Zip Shirt
- Quarter-Zip Pant
- Barrier Fleece Jacket
- Barrier Fleece Vest



### STEP 3

- Protection Layer
- Mountain eVT Jacket
- Octane Jacket

The three layering combinations above contain different layers giving you different results. Try adding and removing layers to meet your level of warmth and comfort.

## THE THREE W'S TO COMFORT: WICKING, WARMTH, WATERPROOF

### LIGHT WEIGHT LAYER



#### A. BASELAYER THERMALS

- 100% Polyester
- Microfiber moisture wicking fabric
- Provides thermal insulation
- Pill-proof durability

PART NO. 2868046 | MOCK NECK | S-2XL

PART NO. 2868047 | MEN'S PANT | S-2XL

\* Limited availability

### MEDIUM WEIGHT LAYER



#### B. BACKCOUNTRY RIDING SHIRT

- 84% Nylon, 16% Spandex
- Thermal waffle construction
- Storage pocket
- For layering or streetwear

PART NO. 2869085 | RED / GRAY | S-2XL

PART NO. 2869086 | BLACK / GRAY | S-2XL

### MEDIUM WEIGHT LAYER



#### C. QUARTER-ZIP RIDING SHIRT & PANTS

- 100% Polyester
- Shirt features a zip mock neck
- Pant features draw cord waist & rear pocket
- Can be worn alone or as a layering piece

PART NO. 2869083 | SHIRT, BLACK | S-2XL

PART NO. 2867051 | PANT, BLACK | S-2XL

### HEAVY WEIGHT LAYER



#### D. BARRIER FLEECE JACKET, VEST & PANT

- 100% Polyester
- Anti-pill microfleece
- Jackets with drop tail hem & elastic drawcord
- Left chest pocket
- Vest not shown

PART NO. 2868039 | JACKET, BLACK/RED | S-2XL

PART NO. 2869082 | VEST, BLACK | S-2XL

#### E. ASCENT XT SOFTSHELL JACKET

The perfect light jacket. Use it for layering in cold weather and for spring and fall rides. Windproof and waterproof with exterior seam tape.

- Shell:** Light flexible softshell fabric, 60% polyester, 40% nylon
- Windproof/Waterproof Breathable:** (3000mm/3000g) fabric delivers windproof, waterproof and breathable performance
- Pockets:** Two handwarmer pockets, one chest pocket
- Additional Features:** Taped exterior seams for maximum waterproof protection, drawcord waist helps keep wind and snow out. Microfleece rollover collar.

PART NO. 2869109 | BLACK | MEN'S S-3XL

\* Limited availability



E



F

#### F. ASCENT SOFTSHELL JACKET

Great for spring and fall rides, and perfect for layering in cold weather. The flexible softshell gives excellent mobility. Windproof, waterproof and breathable.

- Shell:** Light flexible softshell fabric, 60% polyester, 40% nylon
- Windproof/Breathable:** (3000mm/3000g) fabric delivers windproof, breathable performance
- Pockets:** Two handwarmer pockets, one chest pocket
- Additional Features:** Drawcord waist helps keep wind and snow out. Polaris logo on chest.

PART NO. 2869110 | BURNT ORANGE | MEN'S S-3XL



G

#### G. WINDBLOC JACKET

The ultimate fleece because it adds warmth, blocks the cold wind and breathes. Perfect for layering under your snowmobile jacket or as casual wear after the ride.

- Shell:** Three-layers, outer fleece, wind-blocking membrane and soft, red interior fleece
- Windproof Breathable:** (3000mm/3000g) fabric delivers windproof and breathable performance
- Pockets:** Two handwarmer pockets, left chest pocket

PART NO. 2868037 | BLACK | MEN'S S-2XL

ADULT SIZE CODES FOR ORDERING (SEE COMPLETE SIZE CODE CHARTS ON PAGE 181)

Don't forget to add the two-digit size code at the end of the part number! See size availability in the item description, not all sizes available in all styles.

XS = 01	M = 03	M-TALL = 05	L-SHORT = 07	XL = 09	XL-TALL = 11	2XL-TALL = 13
S = 02	M-SHORT = 04	L = 06	L-TALL = 08	XL-SHORT = 10	2XL = 12	3XL = 14

HELMETS  
PG. 160 - 165

GOGGLES  
PG. 165

GLOVES / PROTECTION  
PG. 166 - 167

MEN'S JACKETS  
PG. 168 - 171

WOMEN'S JACKETS  
PG. 172 - 173

PANTS / BOOTS  
PG. 174 - 175

MEN'S CASUAL  
PG. 176 - 177

WOMEN'S CASUAL  
PG. 178 - 179

CAPS / BEANIES  
PG. 180

GEAR BAGS  
PG. 181

COLLECTIBLES  
PG. 181

FIT CHARTS  
PG. 181



# WOMEN'S JACKETS

**PURE COMFORT AND FASHION.** Pure Polaris women's jackets are built to keep you warm, comfortable and stylish on and off the trail. Beneath their feminine designs are the same high-tech fabrics, warm and breathable insulation, and functional features proven in our men's jackets.



A

## A. WOMEN'S SIREN JACKET

Built with the woman rider in mind. A great combination of fashionable design and functional features, so you can ride the trails in comfort and style.

- **Shell:** Cordura
- **Windproof/Breathable:** Water resistant
- **Insulation:** Non-insulated, mesh lined
- **Venting:** Full zip vents at underarm and back
- **Pockets:** 2 hand, 1 interior
- **Additional Features:** Waterproof front closure, stretch side panels, adjustable neck and wrist closures

PART NO. 2869269 | BLACK / PINK | WOMEN'S S-2XL



Coordinating riding gear is easy with Pure Polaris. Matching designs on helmets, gloves and outerwear keep you looking your best on every ride, while the latest high-tech fabrics and features help keep you warm, comfortable and protected. Shown here are the Momentum Helmet, Racing Gloves, Women's Holeshoot Jersey and Women's Siren Pant.

## B. WOMEN'S eVT JACKET

Out on the trails, women also want a jacket shaped to their body type featuring the revolutionary eVent fabric. Because it's uninsulated, you can wear it over a single layer or multiple layers to match the weather and ride in ultimate comfort.

- **Shell:** 100% Nylon Shell. Waterproof Breathable: eVent® fabric.
- **Insulation:** Non-insulated, mesh lined
- **Venting:** Full zip vents at underarm and back
- **Pockets:** Three exterior pockets, one with chamois cloth inside to wipe goggles/shield, two interior pockets
- **Additional Features:** Waterproof two-way front zipper. Microfleece rollover collar for rider comfort. Dirt skirt and adjustable back drawcord keep dust out.
- **Safety:** 3M® reflective ellipse patches

PART NO. 2869047 | BLACK / PINK | S-2XL

PART NO. 2869046 | BLACK / RED | S-2XL



B



BACK VENT



IPOD READY



CHAMOIS CLOTH



C

## C. ASCENT SOFTSHELL JACKET NEW 2010

- **Shell:** Three-layered; hard-face outer, soft fleece interior and windproof in between layer.
- **Windproof/Breathable:** (3000mm/3000g) fabric delivers windproof, breathable performance
- **Pockets:** Two zippered exterior pockets and one chest pocket
- **Additional Features:** Drawcord waist helps keep wind and dust out

PART NO. 2860122 | PEARL | S-XL



D

## D. ABBY FLEECE NEW 2010

- **Shell:** 100% Polyester, anti-pill fleece
- **Pockets:** Two zippered exterior pockets
- **Additional Features:** Great for layering or just wearing around the cabin

PART NO. 2860128 | CHOCOLATE | S-2XL



E

## E. HAILEY FLEECE

- **Shell:** 100% Polyester, anti-pill fleece
- **Pockets:** Two zippered exterior pockets
- **Additional Features:** Great for layering or just wearing around the cabin

PART NO. 2869081 | MAGENTA | S-2XL

\*Limited Availability



F

## F. WOMEN'S BARRIER FLEECE JACKET

- **Shell:** 100% Polyester, anti-pill fleece
- **Pockets:** Multiple storage pockets
- **Additional Features:** Drop tail hem & elastic drawcord

PART NO. 2868041 | BLACK | S-2XL

ADULT SIZE CODES FOR ORDERING (SEE COMPLETE SIZE CODE CHARTS ON PAGE 181)

Don't forget to add the two-digit size code at the end of the part number! See size availability in the item description, not all sizes available in all styles.

XS = 01	M = 03	M-TALL = 05	L-SHORT = 07	XL = 09	XL-TALL = 11	2XL-TALL = 13
S = 02	M-SHORT = 04	L = 06	L-TALL = 08	XL-SHORT = 10	2XL = 12	3XL = 14

REFERENCE FIT CHARTS ON PG. 181 BEFORE ORDERING.  
VISIT PUREPOLARIS.COM FOR MORE INFORMATION.



# RIDING PANTS

**PURE COMFORT AND FASHION.** Be ready for anything with our all-new Transform Pant. They zip off at the knees, keeping you cool when it's hot. Serious riding features include mesh lining, stretch knee panels, removable knee armor and much more. Designed to fit over shorts and jeans. Coordinates with Off-Road Jacket.

## A. TRANSFORM PANT NEW

Be ready for anything with our all-new Transform Pant. They zip off at the knees, keeping you cool when it's hot. Serious riding features include mesh lining, stretch knee panels, removable knee armor and much more. Designed to fit over shorts and jeans. Coordinates with Off-Road Jacket.

- **Shell:** Polycordura
- **Waterproof Breathable:** Water resistant
- **Pockets:** Two exterior pockets
- **Additional Features:** Legs zip off at the knees, mesh lining, 2 zip pockets, rear stretch panel, zip front with closure, stretch knee panel, removable knee armor, Velcro® cuff and side adjustments

PART NO. 2860173 | BLACK | 28-42



A

Velcro® side adjustment

Rear stretch panel for added comfort

Stretch knee panel for extra mobility

Velcro® cuff adjustment for snug fit around boot



> Zip-off lower legs for warm weather riding



> Removable knee armor adds protection

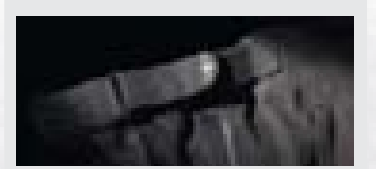

> Adjustable Velcro® waist



B

C

## B. DIGITAL CAMO PANT

There's no such thing as owning too much camo. These rugged riding pants feature the latest in digital camo, plus stretch panels for comfort and plenty of pockets.

- **Shell:** Polycordura
- **Additional Features:** 2 hand pockets, 2 cargo pockets, accordian stretch panels in hip, knee and back area for increased mobility, adjustable Velcro® waist closures, lower leg zipper with external flap

PART NO. 2869273 | DIGITAL CAMO | MEN'S 28-42

\* Upsize by one when ordering

## C. WOMEN'S SIREN PANT

Protect yourself from wind, dust and mud while riding. Stretch panels offer mobility and comfort. Pants match up perfectly with the Siren Jacket and just about anything in your off-road wardrobe.

- **Shell:** Polycordura
- **Additional Features:** 2 hand pockets, 2 cargo pockets, accordian stretch panels in hip, knee, and back area for increased mobility, adjustable Velcro® waist closures, lower leg zipper with external flap

PART NO. 2869270 | BLACK / PINK | WOMEN'S 28-36

\* Upsize by one when ordering



## XTREME III BOOTS

Whether working in the shop or riding on the trail, this boot is perfect for all conditions. Its versatility allows feet to stay dry on rainy days and warm on cold days.

- **Upper:** Leather
- **Sole:** High-traction rubber
- **Insulation:** 990g Thinsulate™
- **Additional Features:** AquaPlus™ waterproof breathable, built-in handles for easy on/off

PART NO. 2869115 | BLACK | MEN'S 7-14

ADULT PANT SIZE CODES FOR ORDERING (SEE COMPLETE SIZE CODE CHARTS ON PAGE 181)

XS / 28" - 28	M / 32" - 32	XL / 36" - 36	40" - 40
S / 30" - 30	L / 34" - 34	38" - 38	42" - 42

Don't forget to add the two-digit size code at the end of the part number! See size availability in the item description, not all sizes available in all styles.

ADULT BOOT SIZE CODES FOR ORDERING (SEE COMPLETE SIZE CODE CHARTS ON PAGE 181)

Don't forget to add the two-digit size code at the end of the part number! See size availability in the item description, not all sizes available in all styles. USE BOOT SIZE AS TWO-DIGIT SIZE CODE.

- HELMETS PG. 160 - 165
- GOGGLES PG. 165
- GLOVES / PROTECTION PG. 166 - 167
- MEN'S JACKETS PG. 168 - 171
- WOMEN'S JACKETS PG. 172 - 173
- PANTS / BOOTS PG. 174 - 175**
- MEN'S CASUAL PG. 176 - 177
- WOMEN'S CASUAL PG. 178 - 179
- CAPS / BEANIES PG. 180
- GEAR BAGS PG. 181
- COLLECTIBLES PG. 181
- FIT CHARTS PG. 181

# MEN'S CASUAL

**POLARIS HAS YOU COVERED YEAR-ROUND.** Jerseys, Tees, shirts and hoodies. Our full line of men's casual wear has you covered during all four seasons, so you can show your Polaris pride year-round. Mix and match them to form just the right combination for trail riding to relaxing on the beach.

## A. OUTLAW TEE 100% COTTON

PART NO. 2869431 | GRAY | S-2XL

## B. RANGER RZR SIDE HIT TEE 100% COTTON

PART NO. 2868375 | GRAY | S-2XL

## C. POLARIS RACING TEE 100% COTTON

PART NO. 2869432 | BLACK | S-2XL

## D. GRAFFITI TEE 100% COTTON **NEW 2010**

PART NO. 2860063 | GRAY | M-XL

## E. RANGER RZR TRIBAL TEE 100% COTTON

PART NO. 2869500 | GRAY | S-2XL



## F. OUTLAW L/S TEE 100% COTTON

PART NO. 2869435 | BLACK | S-2XL

## G. RANGER RZR FLAME L/S TEE 100% COTTON

PART NO. 2869436 | RED | S-2XL

PART NO. 2869487 | BLACK | S-2XL

## H. VINTAGE LOGO THERMAL 100% COTTON

PART NO. 2869137 | BLACK | M-2XL

## I. POLARIS '54 L/S TEE 100% COTTON **NEW 2010**

PART NO. 2860062 | RED | M-2XL

## J. TWILL SHIRT 100% COTTON

PART NO. 2869127 | BLACK | S-M

PART NO. 2869128 | WHITE | S-2XL



## K. RACE JERSEY 100% POLYESTER

PART NO. 2869267 | RED/BLACK | S-3XL

## L. RACE JERSEY 100% POLYESTER **NEW 2010**

PART NO. 2860190 | RED | S-2XL



## M. MECHANIC'S SHIRT 35% COTTON / 65% POLYESTER

PART NO. 2869293 | TWO-TONE RACING PIT SHIRT | S-3XL

## N. WWW SHIRT 35% COTTON / 65% POLYESTER

PART NO. 2869294 | CHARCOAL PIT SHIRT | S-3XL



## O. PERFORMANCE SHIRT **NEW 2010**

The perfect lightweight base layer. 100% polyester wicks away moisture to keep you dry and comfortable.

PART NO. 2860055 | BLACK | M-2XL

PART NO. 2860056 | WHITE | M-2XL



## P. RANGER RZR HOODIE 100% COTTON

PART NO. 2869437 | RED | S-2XL

## Q. POLARIS ICON HOODIE **NEW 2010**

80% COTTON EXTERIOR/ POLYESTER INTERIOR

PART NO. 2860058 | BROWN | M-2XL

## R. POLARIS '54 HOODIE 80% COTTON / 20% POLY **NEW 2010**

PART NO. 2860059 | GREEN | M-2XL



## S. RETRO LOGO SHOP JACKET

65% Polyester, 35% Cotton and lightly insulated

PART NO. 2869135 | BLACK, VINTAGE LOGO | M-3XL

ADULT SIZE CODES FOR ORDERING (SEE COMPLETE SIZE CODE CHARTS ON PAGE 181)

Don't forget to add the two-digit size code at the end of the part number! See size availability in the item description, not all sizes available in all styles.

XS = 01	M = 03	M-TALL = 05	L-SHORT = 07	XL = 09	XL-TALL = 11	2XL-TALL = 13
S = 02	M-SHORT = 04	L = 06	L-TALL = 08	XL-SHORT = 10	2XL = 12	3XL = 14

HELMETS  
PG. 160 - 165

GOGGLES  
PG. 165

GLOVES / PROTECTION  
PG. 166 - 167

MEN'S JACKETS  
PG. 168 - 171

WOMEN'S JACKETS  
PG. 172 - 173

PANTS / BOOTS  
PG. 174 - 175

MEN'S CASUAL  
PG. 176 - 177

WOMEN'S CASUAL  
PG. 178 - 179

CAPS / BEANIES  
PG. 180

GEAR BAGS  
PG. 181

COLLECTIBLES  
PG. 181

FIT CHARTS  
PG. 181



# WOMEN'S CASUAL

**SHOW YOUR POLARIS PRIDE.** Polaris apparel helps you look and feel your best on and off the trail. Our full line of women's casual apparel includes 100% cotton, cotton blends and polyester, with many items available in a wide assortment of sizes and colors.



A

B

C

D

E

**A. MOTIVATED L/S TEE** NEW 2010  
100% COTTON

PART NO. 2860077 | TEAL | S-XL

**B. BLOSSOM ZIP HOODIE** NEW 2010  
100% COTTON

PART NO. 2860073 | BLUE | S-XL

**C. MIDNIGHT ELLIPSE L/S TEE** NEW 2010  
100% COTTON

PART NO. 2860078 | BLACK | S-XL

**D. MOTIVATED L/S TEE** NEW 2010  
100% COTTON

PART NO. 2860076 | BLACK | S-XL

**E. BLOSSOM ZIP HOODIE** NEW 2010  
100% COTTON

PART NO. 2860074 | PINK | S-XL

**F. POTPOURRI HOODIE & PANT** NEW 2010  
100% COTTON

PART NO. 2860069 | HOODIE, WHITE | S-XL

PART NO. 2860070 | SWEATPANTS, BLACK | S-XL



BACK OF PANT

F

**G. CHIANTI FLORAL HOODIE** NEW 2010  
100% COTTON

PART NO. 2860068 | PINK | S-XL

**H. ALLISON HOODIE** NEW 2010  
100% POLYESTER

PART NO. 2860067 | BLUE | S-XL



G

H



I

**I. VINTAGE LOGO MECHANIC'S SHIRT** NEW 2010  
65% POLYESTER, 35% COTTON

PART NO. 2860079 | BLACK | S-2XL

**J. REACTIVE DIAMONDS TEE** NEW 2010  
100% COTTON

PART NO. 2860072 | BLACK | S-XL

**K. BLOCK RACING TEE**  
100% COTTON

PART NO. 2869438 | PINK | S-XL

**L. MOTIVATED S/S TEE** NEW 2010  
100% COTTON

PART NO. 2860075 | WHITE | S-XL



J

K

L



M

N

**M. PERFORMANCE SHIRT** NEW 2010  
100% POLYESTER

PART NO. 2860065 | WHITE | S-XL

PART NO. 2860066 | BLACK | S-XL

**N. WOMEN'S HOLESHOT JERSEY**  
100% POLYESTER

PART NO. 2869266 | PINK | S-2XL

ADULT SIZE CODES FOR ORDERING (SEE COMPLETE SIZE CODE CHARTS ON PAGE 181)

Don't forget to add the two-digit size code at the end of the part number! See size availability in the item description, not all sizes available in all styles.

XS - 01	M - 03	M-TALL - 05	L-SHORT - 07	XL - 09	XL-TALL - 11	2XL-TALL - 13
S - 02	M-SHORT - 04	L - 06	L-TALL - 08	XL-SHORT - 10	2XL - 12	3XL - 14

- HELMETS PG. 160 - 165
- GOGGLES PG. 165
- GLOVES / PROTECTION PG. 166 - 167
- MEN'S JACKETS PG. 168 - 171
- WOMEN'S JACKETS PG. 172 - 173
- PANTS / BOOTS PG. 174 - 175
- MEN'S CASUAL PG. 176 - 177
- WOMEN'S CASUAL PG. 178 - 179
- CAPS / BEANIES PG. 180
- GEAR BAGS PG. 181
- COLLECTIBLES PG. 181
- FIT CHARTS PG. 181

# BALLCAPS & HEADWEAR

**THE SOLUTION TO HELMET HAIR.** You can't have too many caps and beanies. Choose your favorites from this big selection of designs and colors.



**A. RANGER RZR TRUCKERS CAP**  
2869447 | RED | OSFA



**B. RANGER RZR CLASSIC CAP**  
2869448 | BLACK | OSFA



**C. RANGER RZR FLAT BILLED CAP**  
2869449 | BLACK | OSFA



**D. OUTLAW GUNSMOKE CAP**  
2869451 | BLACK/RED | OSFA



**E. POLARIS REBEL CAP**  
2860088 | WHITE | FITTED



**F. POLARIS PINSTRIPE CAP**  
2869445 | BLACK | FITTED



**G. POLARIS FLAME RED CAP**  
2869169 | RED | OSFA



**H. POLARIS FLAME BLACK CAP**  
2869168 | BLACK | OSFA



**I. HIDDEN ELLIPSE CAP**  
2860087 | BLACK | OSFA



**J. POLARIS TRUCKERS CAP**  
2860089 | RED/WHITE | OSFA



**K. WOMEN'S ALTERNATIVE CAP**  
2860091 | CREAM | OSFA



**L. RANGER RZR BEANIE**  
2869457 | BLACK | OSFA



**M. OUTLAW BEANIE**  
2869455 | BLACK/GRAY | OSFA



**N. REVERSIBLE RANGER BEANIE**  
2869456 | CAMO/ORANGE | OSFA



**O. RACING RADAR BEANIE**  
2860095 | BLACK | OSFA



**P. CAMO BEANIE**  
2869184 | SNOW CAMO | OSFA



**Q. BLACK SIDE HIT BEANIE**  
2860094 | RED/BLACK | OSFA



**R. POLARIS TRIBAL BEANIE**  
2860097 | BLACK | OSFA



**S. DISTRESSED SKULLS BEANIE**  
2869191 | BLACK | OSFA

**DEALERS:** Ballcaps and Headwear come pre packed 6 per package. Note: OSFA = One Size Fits All.

# BAGS, COLLECTIBLES & SIZING



T



U



V

## POLARIS BAGS

- T. PART NO. 2860137 POLARIS/OGIO® 9800 ROLLER BAG | 34" H X 14" W X 17" D | WHITE / BLACK **NEW 2010**
- U. PART NO. 2860109 POLARIS/OGIO® UNIVERSAL BACKPACK | 19" H X 13" W X 8" D | WHITE / BLACK **NEW 2010**
- V. PART NO. 2868459 POLARIS/OGIO® BIG WHEEL DUFFEL BAG | 12" H X 12" W X 28" D | RED / BLACK

## POLARIS COLLECTIBLES

- PART NO. 2860100 POLARIS OUTDOOR THERMOMETER
- PART NO. 2860101 POLARIS ONLY PARKING SIGN
- PART NO. 2860102 POLARIS ZIPPER PULL THERMOMETER / WHISTLE
- PART NO. 2860103 POLARIS TRAVEL TUMBLER / MUG
- PART NO. 2860106 POLARIS KEYCHAIN

## MEN'S JACKET & PANT SIZING

SIZE	CHEST	SLEEVE	WAIST	INSEAM
S	34-36	33	28-30	33
M	38-40	34	32-34	33½
M Tall	38-40	35½	32-34	35½
L	42-44	35	36-38	34
L Tall	42-48	36½	36-38	36
XL	46-48	36	40-42	34½
XL Tall	46-48	37½	40-42	36½
2XL	50-52	37	44-46	35
XX-L Tall	50-52	38½	44-46	37
XXX-L	50-52	37½	48-50	35½

Men's regular 5'8" to 6'0," tall 6'0" to 6'4"  
Tall is 2" longer and shorts are 2" shorter than standard size.

## WOMEN'S JACKET & PANT SIZING

SIZE	CHEST	SLEEVE	WAIST	INSEAM
S	32-34	34½-36½	24-26	30
M	34-36½	36½-39	26-28½	31
L	37-39½	39½-42	29-31½	31½
XL	40½-43½	43-46	32½-35½	32
2XL	44-47½	47½-50	36-39½	32

Women's regular 5'4" to 5'7," tall 5'8" to 5'11," petite 5'2" to 5'5"  
Tall is 2" longer and shorts are 2" shorter than standard size.

## BOOT SIZING CHART

MEN'S		07	08	09	10	11	12	13	14
CODE		07	08	09	10	11	12	13	14
SIZE		7	8	9	10	11	12	13	14

\*Order one size larger than shoe size.

## HELMET SIZING CHART

SIZE	CHEST	WAIST	HEIGHT	HIP
S - 6/8	23-26	23-25	45-52	22-25
M - 10/12	27-29	26-27	55-59	26-28
L - 14/16	31-33	28-29	62-64	30-31½
XL - 18	34	30	66	33

## ADULT SIZE CODES FOR ORDERING

Don't forget to add the two-digit size code at the end of the part number! See size availability in the item description, not all sizes available in all styles.

XS = 01	M = 03	M-TALL = 05	L-SHORT = 07	XL = 09	XL-TALL = 11	2XL-TALL = 13
S = 02	M-SHORT = 04	L = 06	L-TALL = 08	XL-SHORT = 10	2XL = 12	3XL = 14

HELMETS  
PG. 160 - 165

GOGGLES  
PG. 165

GLOVES / PROTECTION  
PG. 166 - 167

MEN'S JACKETS  
PG. 168 - 171

WOMEN'S JACKETS  
PG. 172 - 173

PANTS / BOOTS  
PG. 174 - 175

MEN'S CASUAL  
PG. 176 - 177

WOMEN'S CASUAL  
PG. 178 - 179

CAPS / BEANIES  
PG. 180

GEAR BAGS  
PG. 181

COLLECTIBLES  
PG. 181

FIT CHARTS  
PG. 181



# OILS & LUBES

**KEEP YOUR ENGINE PURE.** Insist on Pure Polaris oils and lubricants. They are specially formulated to help you maintain your machine's high performance. Be sure to use them as part of your routine machine maintenance schedule.



This cam shows a worn lobe which can lead to reduced or even failed performance as a result of the use of inferior lubricants.

## PS-4 PLUS SYNTHETIC ENGINE OIL

Pure Polaris PS-4 Plus full synthetic 4-cycle engine oil is designed specifically for and recommended for all 4-stroke Polaris ATVs and RANGER® vehicles. It provides maximum engine protection and ultimate performance at extreme operating temperatures, hot or cold, plus improved cold temperature starting. With over 600,000 miles of testing and thousands of dyno hours, our oils are proven and tested before they ever reach the shelf in your garage, for the dependability and peace of mind that only Pure Polaris lubricants deliver.

- Provides superior performance in all Polaris applications, including wet clutches and gear boxes
- Protects in extreme operating temperatures generated by hard-riding or racing
- Available in quarts, gallons and oil change kits

PART NO. 2876244 946 ML (12 per case)

PART NO. 2876245 3.78 L (4 per case)

PART NO. 2876247 60.5 L Gallon

PART NO. 2876246 208 L Gallon

## ENHANCED LUBRICITY WITH PS-4 PLUS

Enhanced lubricity protects internal engine parts. PS-4 oil offers outstanding film strength that coats and protects, to drastically reduce sliding friction, providing optimum hydrodynamic lubrication. Polaris 4-cycle engines generate high horsepower from small displacement platforms, resulting in high temperature strains on piston, rings, crankshaft, bearings and other internal engine components. PS-4 PLUS' synthetic base stocks and optimized additive chemistries assure the best lubricity, to protect and prolong the life of these internal components.



## A. OIL CHANGE KITS

PART NO. 2877473 Sportsman XP (4 per case)

PART NO. 2876738 Single Cylinder (450-500 engines)(4 per case)

PART NO. 2202166 Twin Cylinder (600-700-800 engines)(4 per case)

PART NO. 2202511 Predator and Outlaw 500 (4 per case)

PART NO. 2875523 Phoenix and Sawtooth (4 per case)



## B. ATV/RANGER MAINTENANCE KIT

PART NO. 2859086 All full-size ATV and RANGER product (4 per case)

## C. HYDRAULIC CLUTCH FLUID

PART NO. 2876335 946 ML

## D. DEMAND DRIVE PLUS

Replaces Demand Drive Fluid, LT Demand Drive Fluid and ADC fluid.

PART NO. 2877922 946 ML (12 per case)

PART NO. 2877923 9.46 L (2 per case)

## E. ATV ANGLE DRIVE FLUID

PART NO. 2876160 946 ML (12 per case)

PART NO. 2872276 9.46 L (2 per case)



## F. PREMIUM SYNTHETIC AGL GEAR LUBE

PART NO. 2873602 946 ML (12 per case)

PART NO. 2873603 3.78 L (4 per case)

PART NO. 2873604 9.46 L (2 per case)

## G. PREMIUM ANTIFREEZE

PART NO. 2871534 946 ML (12 per case)

PART NO. 2871323 3.78 L (6 per case)

PART NO. 2872278 208 L





**NEW 2010**  
**EASY START**

### VES GOLD PLUS SYNTHETIC 2-CYCLE OIL

We set out to improve our best oil, VES Gold and have produced the best performing oil for the next generation of Polaris 2-cycle vehicles. With an excess of 600,000 miles and thousands of dyno hours, our oils are proven and tested before they ever reach the shelf in your garage, for the dependability and peace of mind that Pure Polaris lubricants deliver. Formulated for all Polaris 2-cycle engines including those with variable exhaust systems. Engineered to provide:

- Improved Cold Starting
- Cleaner Valves
- Better Lubricity
- Smokeless / Low-Odor Operation
- Exceeds Category IV Low Temperature Performance

PART NO. 2877882 946 ML (6 per case)

PART NO. 2877953 1.89 L bottle (8 per case)

PART NO. 2877883 3.78 L (4 per case)

PART NO. 2877884 9.46 L (2 per case)

PART NO. 2877885 60.5 L

PART NO. 2877886 208 L

PART NO. 2877892 1249 L



### PREMIUM SYNTHETIC BLEND 2-CYCLE OIL

PART NO. 2875035 946 ML (12 per case)

PART NO. 2875036 3.78 L (6 per case)

PART NO. 2875038 9.46 L (2 per case)

PART NO. 2875037 6.05 L

PART NO. 2875039 208 L

PART NO. 2875040 1249 L



### YOUTH ATV OIL 4-CYCLE OIL

PART NO. 2876248 946 ML (6 per case)



### H. FOGGING OIL

PART NO. 2870791 .354 L (12 per case)

### I. CARBON CLEAN FUEL TREATMENT

PART NO. 2871326 .354 L (12 per case)

### J. PERMIUM FUEL STABILIZER

PART NO. 2870652 946 ML (12 per case)

PART NO. 2872280 9.46 L (2 per case)

### K. ISOPROPYL FUEL DE-ICER

PART NO. 2870505 946 ML (12 per case)



### L. BRAKE FLUID - DOT 4

PART NO. 2872189 .354 L (12 per case)

### M. CHAIN LUBE

PART NO. 2872348 .473 L (12 per case)

### N. GREASE GUN KIT

PART NO. 2871312 Accepts .088 L tubes (4 per case)

### O. ALL SEASON GREASE

PART NO. 2871322 .088 L 4-pack (6 per case)

PART NO. 2871423 .414 L (10 per case)



### P. PREMIUM U-JOINT GREASE (NOT SHOWN)

PART NO. 2871515 .088 L (24 per case)

PART NO. 2871551 .414 L (10 per case)

### Q. PREMIUM STARTER GREASE (NOT SHOWN)

PART NO. 2871460 .056 L (12 per case)

### R. FOAM AIR FILTER OIL

PART NO. 2877164 946 ML (6 per case)



OILS  
PG. 182 - 185

LUBES  
PG. 182 - 185

FILTERS  
PG. 186 - 187

BELTS  
PG. 186 - 187

BATTERIES  
PG. 186 - 187

TRAILERS  
PG. 188 - 189



# MAINTENANCE

**POWER & PERFORMANCE.** Your Polaris ATV or Side-by-Side is built to take a pounding on the toughest terrain on earth. Keep it that way by following maintenance schedules and insisting that all the filters, oils and lubricants used in your machine are Pure Polaris. They're designed and formulated specifically for your Polaris vehicle, with the highest quality ingredients to keep the engine, transmission, drive train, suspension and brakes operating at peak performance.

## A. K&N AIR FILTERS

- Less restrictive than stock filters
- Enhances air flow without sacrificing filtering efficiency
- Reusable

PART NO. 2871786

FITMENT Sportsman 335/400/500/600/700/800, Xplorer 500, Sportsman 6x6, Scrambler 500, Xpedition 325/425, Trailboss 325 (2000-01), Diesel, RANGER 500

PART NO. 2871508

FITMENT Magnum 425, Scrambler 400, Sport, 400L, Big Boss 500, Xplorer 400

PART NO. 2874209

FITMENT Predator MY 03-07

PART NO. 2876739

FITMENT Outlaw 525/IRS



A



## B. AIR FILTERS

- Clean air filters allow maximum engine horsepower / decreases engine wear
- Decreases risk of engine fuel delivery problems / maximizes fuel economy
- Designed to trap tiny particles but still allow engine to breathe properly
- Air filters should be inspected before each ride. Filter and pre-filter need to be replaced at least annually and more often if subjected to severe use.



B

PART NO. 7080595

FITMENT 4-stroke models (except Outlaw 325/330/300)

PART NO. 1253355

FITMENT 2-stroke models (except Scrambler 400, 2x4, MY 02-03 Trailblazer 400)

PART NO. 1253118

FITMENT Scrambler 400, 2x4, MY 02-03 Trailblazer 400

PART NO. 1253372

FITMENT Trailboss 325/330

PART NO. 7081308

FITMENT Ranger 400/500/700/800

PART NO. 1240482

FITMENT RZR, RZR "S"

PART NO. 7080369

FITMENT Select 250/300/350/400 2-stroke models

## C. OIL FILTERS

- Manufactured at a higher standard - uses only the highest quality materials
- Designed to better handle the oil volume and flow of Polaris engines
- Clean oil increases engine life. For most ATVs and RANGERS, oil and filter should be changed initially at 25 hours on new engines and every 100 hours or 6 months after that (25-50 hours for severe duty). For Outlaws, the initial change is at 3 hours and every 15 hours or 6 months (whichever comes first) after that.



C

PART NO. 3084963

FITMENT All 4-stroke models except Sportsman 600/700/800, Predator

PART NO. 2540086

FITMENT Sportsman 600/700/800, RANGER 700/800, RZR, RZR S

PART NO. 2520799

FITMENT Sportsman XP 550/850, MY09 RANGER 500 EFI

PART NO. 3088036

FITMENT MY04-07 Predator 500, MY 06-07 Outlaw 500

PART NO. 2520755 (Short)

FITMENT Outlaw 450/525/S

PART NO. 2520754 (Long)

FITMENT Outlaw 450/525/S

## D. PREFILTER

- Slips over stock air filter
- Extends life of air filter
- Water repellent - can be cleaned many times

PART NO. 5811633

FITMENT All 4-stroke models except 325/330 and Predator



D



E

## E. DRIVE BELTS

- Engineered, tested and guaranteed to fit and perform on Polaris machines
- Lowest tolerances (.188") - provide the most consistent performance
- Precision measured to ensure stringent tolerances are met for both length and width

PART NO. 3211077

FITMENT Select 250/300/325/330/350/400/500 models

PART NO. 3211069

FITMENT Select 325/500 Magnum/Diesel/Sportsman 500

PART NO. 3211091

FITMENT Select Sportsman 500/600/700/X2 models

PART NO. 3211095

FITMENT Select Sportsman 500 models (2003-5)

PART NO. 3211106

FITMENT RANGER 700/Sportsman 800

PART NO. 3211113

FITMENT Select MY07-09 Sportsman 500/700/800/RZR

PART NO. 3211133

FITMENT MY08-10 RANGER 700/800 4x4, XP, Crew, 6x6, RZR S

## F. BRAKE PADS

- Engineered, tested and guaranteed to fit and perform on Polaris machines
- Replacing worn brake pads at the recommended service limits ensures maximum stopping power and avoids major brake repair expense
- See service manuals for brake pad thickness service limits
- See parts catalog for exact machine fitment



F

PART NO. 2202412 Front brake pads (4)

FITMENT ATV/RZR/RZR "S"

PART NO. 2202413 Front/rear brake pads (4)

FITMENT RANGER

PART NO. 2202414 Rear brake pads (2)

FITMENT ATV

PART NO. 2200465 Front/Middle brake pads (4)

FITMENT ATV



G

## G. BATTERIES

- Polaris uses only the highest quality batteries
- Have strong cold cranking amps for most starting applications
- Plenty of reserve capacity for accessories
- Easy-to-see electrolyte check
- Engineered, tested and guaranteed to fit and perform on Polaris machines

### YB14A-A2 (4140006) / YB30L-B (4010630) / (4011224)

- Designed to withstand severe vibrations
- Uses Yumicron separator that provides 30% more cranking power than conventional battery
- Added power ideal for heavily accessorized machines and high compression engines

### YTX20HL (4011496) / YTX14AH (4010774) / (4011138)

- Higher cranking, spill-proof, maintenance free batteries
- Discharges less in storage and has longer life than conventional batteries
- Most compact design

### Y1X30L (4010595)

- Uses VRLA technology that eliminates water loss
- Permanently sealed - maintenance free
- Lead calcium design equals longer times between charges during standby periods

PART NO. YB14A-A2 (4140006)

FITMENT Multiple product lines - see parts catalog

PART NO. YB30L-B (4010630)

FITMENT Select Sportsman 500/600/700/RANGER 500/700

PART NO. Y1X30L (4010595)

FITMENT Select Sportsman 500/700/800 - Touring and X2

PART NO. YTX14AH (4010774)

FITMENT Multiple product line - see parts catalog

PART NO. 4011224

FITMENT Sportsman 800/Sportsman 850

PART NO. 4011138

FITMENT Select Trail Boss, Trail Blazer, Scrambler, ATP, Sportsman 400/450/500

# FIT CHARTS



2010 FIT CHARTS

PRODUCT NAME	PART NO.	RANGER											
		MY 10 RANGER 400L EV	MY 10 RANGER 404L XP	MY 10 RANGER 400	MY 10 RANGER 406	MY 10 RANGER CREW	MY 09 RANGER 404L XP	MY 09 RANGER 400	MY 08-09 RANGER 204L 4N4	MY 08-09 RANGER 400	MY 08-09 RANGER 406	MY 08-09 RANGER CREW	
<b>RANGERWARE</b>													
Roof & Rear Panel Sage Green	2878017-498		X	X							X		
Roof & Rear Panel Solar Red	2878017-342		X	X							X		
Roof & Rear Panel Black	2878017-070		X	X							X		
Doors Sage Green	2878016-498		X	X							X		
Doors Solar Red	2878016-342		X	X							X		
Doors Black	2878016-070		X	X							X		
Tip Out Windshield Sage Green	2878015-498		X	X	X	X	X	X			X		
Tip Out Windshield Solar Red	2878015-342		X	X	X	X	X	X			X		
Tip Out Windshield Black	2878015-070		X	X	X	X	X	X			X		
Fixed Windshield Sage Green	2878014-498		X	X	X	X	X	X			X		
Fixed Windshield Solar Red	2878014-342		X	X	X	X	X	X			X		
Fixed Windshield Black	2878014-070		X	X	X	X	X	X			X		
<b>BESTOP CAB</b>													
Bestop Hard Canopy Top	2876945-067								X	X			
Bestop Rear Panel	2877542-067								X	X			
Bestop Soft Canopy Top	2876946-067								X	X			
Bestop Hard Door Kit	2876950-067								X	X			
Bestop Soft Door Kit	2876949-067								X	X			
Bestop A-Pillar/Quarter Panel Kit	2876947-067								X	X			
Universal Fixed Premium Glass Windshield	2876954-067								X	X			
Universal Premium Tip-Out Glass Windshield	2876955-067								X	X			
Premium Wiper Kit	2876969		X	X	X	X	X	X					
<b>STEEL CAB</b>													
Glass Windshield	2877856	X											
Soft Cab Doors	2877857	X											
Steel Cab Rear Panel	2877858	X											
Steel Cab Roof	2877859	X											
Steel Cab Roof	2877827		X	X	X				X	X			
Steel Cab Rear Panel	2877828		X	X	X	X	X	X					
Steel Cab Doors	2877949		X	X	X				X	X			
Steel Cab Doors With Sliders	2877830-067		X	X	X				X	X			
Steel Cab Door Slider Kit	2877831		X	X	X				X	X			
Tip-Out Glass Windshield	2877948-067		X	X	X	X	X	X					
Steel Cab Roof	2876951-067								X	X			
Steel Cab Rear Panel	2876952-067								X	X			
Steel Cab Doors	2876953-067								X	X			
Universal Premium Fixed Glass Windshield	2876954-067								X	X			
Universal Premium Tip-Out Glass Windshield	2876955-067								X	X			
Premium Wiper Kit	2876969		X	X	X	X	X	X					
<b>POLY CAB</b>													
Corner Block Offs	2878050		X	X	X				X	X			
RANGER Modular Roof	2878048		X	X	X				X	X			
Modular Rear Panel	2878049		X	X	X				X	X			
Modular Doors	2878047		X	X	X				X	X			
RANGER Modular Roof	2876956-067								X	X			
Modular Rear Panel	2876957-067								X	X			
Economy Glass Windshield	2877392-067		X	X	X	X	X	X					
Economy Wiper Kit	2876854		X	X	X	X	X	X					
Economy Poly Windshield (GP)	2876958		X	X	X	X	X	X					
Economy Poly Windshield (HC)	2876959		X	X	X	X	X	X					
<b>CANVAS CAB</b>													
Canvas Roof/RP Enclosure	2877854	X											
Canvas Side Enclosure	2877855	X											
Canvas Roof/RP Enclosure	2876961-067		X	X					X	X			
Canvas Side Enclosure	2876962-067		X	X					X	X			
Economy Glass Windshield	2877392-067		X	X	X	X	X	X					
Economy Wiper Kit	2876854		X	X	X	X	X	X					
Poly Windshield (General Purpose)	2876958		X	X	X	X	X	X					
Poly Windshield (Hardcoat)	2876959		X	X	X	X	X	X					
Poly Windshield (General Purpose)	2877707	X											
Poly Windshield (Hardcoat)	2877708	X											
<b>CREW STEEL CAB</b>													
Tip-Out Glass Windshield	2877948-067		X	X	X	X	X	X					
Steel Cab Rear Panel	2877828		X	X	X	X	X	X					
Steel Doors CREW	2877904-067					X							

PRODUCT NAME	PART NO.	RANGER											
		MY 10 RANGER 400L EV	MY 10 RANGER 404L XP	MY 10 RANGER 400	MY 10 RANGER 406	MY 10 RANGER CREW	MY 09 RANGER 404L XP	MY 09 RANGER 400	MY 08-09 RANGER 204L 4N4	MY 08-09 RANGER 400	MY 08-09 RANGER 406	MY 08-09 RANGER CREW	
<b>CREW STEEL CAB</b>													
Steel Roof CREW	2877903-067					X							
CREW Steel Cab Roof	2877354-067												X
Rear Panel Steel	2873872-067									X	X	X	X
CREW Steel Cab Doors	2877424-067												X
Steel/Glass Flip-Up Windshield	2876272									X	X	X	X
Windshield Wiper For 2876272	2876818									X	X	X	X
Windshield Glass	2873436-067									X	X	X	X
Windshield Wiper Kit (Pair)	2875047									X	X	X	X
Windshield Vent Kit	2875455									X	X	X	X
<b>CREW CANVAS CAB</b>													
CREW Canvas Roof/Rear Panel	2877833-067					X							
CREW Canvas Doors	2877834-067					X							
CREW Soft Top Enclosure	2876815-070												X
CREW Side Enclosure	2876768-070												X
Bestop Soft-Top Cab Package (05-08)	2877141-067								X	X	X		
Windshield Wiper Kit (Pair)	2875047								X	X	X		
<b>STANDARD STEEL CAB</b>													
Standard Steel Roof	2873871-067										X	X	X
Standard Rear Panel	2873872-067										X	X	X
Standard Glass Windshield	2873436-067										X	X	X
Standard Flip-Up Glass Windshield	2876272										X	X	X
Windshield Wiper	2876818										X	X	X
Windshield Wiper Kit (Pair)	2875047										X	X	X
Windshield Vent Kit	2875455										X	X	X
<b>CANVAS CAB</b>													
RANGER Soft Cab Roof Cover	2875616-070										X	X	X
RANGER Soft Doors	2875632-070										X	X	X
<b>CAB COMPONENTS</b>													
Poly Rear Panel	2877712	X											
Sport Roof	2877710	X											
Half Windshield (General Purpose)	2877706	X											
Bimini Top	2877852	X											
Canvas Rear Panel w/ Window (Bimini Style)	2877853	X											
Bimini Top	2876963-067		X	X					X	X			
Bimini Wind Jammer Rear Panel	2877394-067		X	X					X	X			
Sport Roof	2877946		X	X	X				X	X			
Economy Glass Windshield (Fixed)	2877392-067		X	X	X	X	X	X					
Economy Poly Windshield (GP)	2876958		X	X	X	X	X	X	X	X			
Economy Poly Windshield (HC)	2876959		X	X	X	X	X	X	X	X			
Half Windshield (GP)	2876960		X	X	X	X	X	X	X	X			
Corner Block-Off Kit	2877391-067								X	X			
Sport Roof CREW	2877902-067								X				X
CREW Sport Roof	2877353-067												X
Bimini CREW	2877909-067								X				
CREW Bimini Soft Top	2876869-070												X
RANGER Sport Roof	2876399-070										X	X	X
RANGER Sport Roof	2876399-195										X	X	X
RANGER Bimini Soft Top	2876763-070										X	X	X
Side Door Nets (Lower Door Nets)	2876532										X	X	X
Poly Windshield (Polycarbonate Windshield)	2876192										X	X	X
Poly Windshield w/ Hardcoat	2876193										X	X	X
RANGER Half Windshield (Half Windshield)	2876672										X	X	X
Poly Windshield Hardware Kit	2876192H										X	X	X
<b>CAB ACCESSORIES</b>													
Speedkey	2877851	X											
Heater	2877850	X											
Heater Kit	2876967		X	X	X				X	X			
700 EFI Adaptor	2877462			X	X	X	X	X					
Poly Windshield (Hardcoat)	2876959		X	X	X	X	X	X	X	X			
Poly Windshield (General Purpose)	2877707	X											
Poly Windshield (Hardcoat)	2877708	X											
500 EFI Adaptor	2877463		X								X		
Defrost/Cooling Fan	2875391		X	X					X	X	X	X	X



# FIT CHARTS

PRODUCT NAME	PART NO.	RANGER											
		MY 10 RANGER 400L EV	MY 10 RANGER 404L XP	MY 10 RANGER HD	MY 10 RANGER BIG	MY 10 RANGER CREW	MY 09 RANGER 404L XP	MY 09 RANGER HD	MY 05-08 RANGER 204L 4IN4	MY 05-08 RANGER XP	MY 05-08 RANGER BIG	MY 05-08 RANGER CREW	
<b>CAB ACCESSORIES (CONTINUED)</b>													
Dash Defrost Kit	2877491		X	X	X		X	X	X	X	X	X	
Acc Switch Panel	2877908		X	X	X	X	X	X					
Windshield Washer Kit	2877337		X	X	X	X	X	X					
Heater CREW	2877974					X							
Lockable Glove Box Cover Kit	2877342		X	X	X	X	X	X					
Shoulder Bag	2877862	X											
Universal Stereo Installation Kit	2876970		X	X	X	X	X	X					
Kick Panel Speaker Enclosures	2876971		X	X	X	X	X	X					
Kick Panel Speaker Enclosure Kit	2876180								X	X	X	X	
Frame Pod Enclosure Kit	2876181		X	X	X	X	X	X	X	X	X	X	X
KICKER® Marine Grade Speaker Package	2876179		X	X	X	X	X	X	X	X	X	X	X
Jensen® Marine Grade Head Unit With CD, MP3 Inputs (Jensen® Head Unit)	2876173-02		X	X	X	X	X	X	X	X	X	X	X
Reverse Warning Kit	2876228		X	X	X	X	X	X	X	X	X	X	X
Horn Kit	2875048	X	X	X	X	X	X	X	X	X	X	X	X
Jensen® Head Unit Mount Kit (Glove Box)	2877140								X	X	X	X	
Kenwood® AM/FM/CD Stereo	2869510		X	X	X	X	X	X					
Kenwood® Monitor With DVD	2869514		X	X	X	X	X	X					
<b>WINCH</b>													
Polaris 3500 Integrated	2877864		X										
Warn RT30 Integrated	2877865		X										
Polaris Integrated 4500 lb. Winch	2877400								X	X	X	X	
Polaris Integrated Winch 4.5	2877042		X	X	X	X	X	X					
Polaris 4.5 Extreme Kit	2877348		X	X	X	X	X	X					
Polaris Multi-Mount Winch 4.5	2877044		X	X	X	X	X	X					
Warn® RT-40 Integrated	2877401		X	X	X	X	X	X					
Warn® RT-40 Integrated	2896667								X	X	X	X	
Warn® RT-40 Extreme Kit	2877402		X	X	X	X	X	X					
Warn® RT-40 Multi-Mount	2876668		X	X	X	X	X	X	X				
Front Receiver Hitch	2877040		X	X	X	X	X	X					
5 cm Receiver Hitch	2875320	X	X	X	X	X	X	X	X	X	X	X	X
Warn® 4.0 Contactor	2858182		X	X	X	X	X	X	X	X	X	X	X
Warn® 4.0 Rocker Handle	2858183		X	X	X	X	X	X	X	X	X	X	X
CREW/6x6 Multi Mount Warn Winch Cable Kit	2877977				X	X				X	X		
CREW/6x6 Multi Mount Polaris Winch Cable Kit	2877978				X	X				X	X		
<b>LIFT &amp; CARRY</b>													
BOSS® Lift & Carry System	2877047			X					X				
BOSS® Lift & Carry Brush Grapple	2877049			X					X				
BOSS® Lift & Carry Dump Bucket	2877050			X					X				
BOSS® Lift & Carry V-Plow	2877048			X					X				
<b>PLOWS/SUSPENSION</b>													
Glacier Mid Range Plow System	2877343		X	X	X	X	X	X	X	X	X	X	X
Glacier Mid Range Plow Mount	2878010		X	X	X	X	X	X	X	X	X	X	X
BOSS® Plow System	2877046		X	X	X	X	X	X	X	X	X	X	X
Glacier II Plow Mount	2877906	X	X	X	X	X	X	X	X	X	X	X	X
Glacier II Plow Mount	2877185		X	X	X	X	X	X	X	X	X	X	X
Glacier II Plow Frame	2877045	X	X	X	X	X	X	X	X	X	X	X	X
Glacier 183 cm Plow Blade	2875697		X	X	X	X	X	X	X	X	X	X	X
BOSS® Plow System	2876870								X	X	X	X	
Glacier HD Snow Plow Kit	2875028								X	X	X	X	
Glacier Plow Mount Plate (Requires 2875626 & 2875697)	2875698								X	X	X	X	
Glacier Plow Frame (Requires 2875698 & 2875697)	2875626								X	X	X	X	
Glacier 183 cm Plow Blade	2875697		X	X	X	X	X	X	X	X	X	X	X
Plow Markers	2872726	X	X	X	X	X	X	X	X	X	X	X	X
Floating Wear Bar (183 cm Floating Wear Bar)	2875864		X	X	X	X	X	X	X	X	X	X	X
FOX® Front Air Ride Shocks	2877060		X	X	X	X	X	X					
Heavy Duty Front Suspension Kit	2877052		X	X					X	X			
Heavy Duty Front Spring Kit	2876758								X	X	X	X	
Nivomat HD Rear Suspension Kit	2877346		X						X	X			
<b>BOX ACCESSORIES</b>													
Cargo Box Lift 4x4	2875027								X	X	X	X	
Cargo Box Lift 6x6	2875184											X	
Tonneau Bed Cover By Access®	2876255		X	X		X	X	X	X	X	X	X	X
Chainsaw Mount	2875180		X	X	X	X	X	X	X	X	X	X	X
5 cm Receiver Hitch	2875320	X	X	X	X	X	X	X	X	X	X	X	X
RANGER Ramp	2875386	X	X	X	X	X	X	X	X	X	X	X	X
Tool Rack	2877039		X	X	X	X	X	X	X	X	X	X	X

PRODUCT NAME	PART NO.	RANGER											
		MY 10 RANGER 400L EV	MY 10 RANGER 404L XP	MY 10 RANGER HD	MY 10 RANGER BIG	MY 10 RANGER CREW	MY 09 RANGER 404L XP	MY 09 RANGER HD	MY 05-08 RANGER 204L 4IN4	MY 05-08 RANGER XP	MY 05-08 RANGER BIG	MY 05-08 RANGER CREW	
<b>BOX ACCESSORIES</b>													
Track Tie Down System	2877971		X	X	X	X	X	X					X
Track Tie Downs (Requires 2877971)	2877972		X	X	X	X	X	X					X
Flat Bed Kit	2877058		X	X	X	X	X	X					
Bed Wall Extensions	2877905		X	X									
Bed Wall Extensions	2875054										X	X	X
<b>STORAGE/RACKS</b>													
Box Topper Canvas	2877832-067		X	X		X	X	X					
Center Seat Console	2877062		X	X	X	X	X	X					
Lock & Ride Cargo Box	2877033	X	X	X					X	X	X	X	X
Cargo Box	2875056		X	X	X	X	X	X	X	X	X	X	X
Cargo Box Divider	2875057		X	X	X	X	X	X					
Box Rack	2876173-418										X	X	X
Box Rack	2876543-521		X	X		X	X	X					
Spare Tire Bar	2876191-418		X	X	X	X	X	X	X	X	X	X	X
Spare Tire Holder (Spare Tire Mount)	2875185		X	X					X	X	X	X	X
Extreme Box Rack Cargo Net	2876533										X	X	X
<b>COVERS</b>													
Trailerable Cover	2877860-067	X											
Trailerable Cover	2877395-067		X	X					X	X			
Storage Bin Cover	2877397		X	X	X	X	X	X					
Lockable Glove Box Cover	2877342		X	X	X	X	X	X					
Dash Compartment Nets	2877396		X	X	X	X	X	X					
Storage Bin Cooler Insert	2877398		X	X	X	X	X	X					
<b>HUNTING</b>													
Gun Scabbard Mount	2877709	X											
Bow Case Mount	2877038-521	X	X	X	X	X	X	X	X	X	X	X	X
Gun Scabbard Mount	2877036		X	X	X	X	X	X	X	X	X	X	X
Dual Gun Scabbard Mount	2875181		X	X	X	X	X	X	X	X	X	X	X
Kolpin® Gun Boot IV	2872677		X	X	X	X	X	X	X	X	X	X	X
Kolpin® Gun Boot IV Mossy Break Up	2872677-419		X	X	X	X	X	X	X	X	X	X	X
<b>LIGHTING</b>													
Halogen/LED Aux Knockout Light Kit	2877070		X	X	X	X	X	X	X	X	X	X	X
Black Rally Light	2877335	X	X	X	X	X	X	X	X	X	X	X	X
PIAA Light	2876684	X	X	X	X	X	X	X	X	X	X	X	X
Auxiliary Fog Light Harness (2 Light)	2877399		X	X	X	X	X	X	X	X	X	X	X
Auxiliary Fog Light Harness (3 Light)	2877336		X	X	X	X	X	X	X	X	X	X	X
Auxiliary Fog Light Harness (2 Light)	2877910		X										
Auxiliary Fog Light Harness (3 Light)	2877911		X										
Auxiliary Battery Kit	2877866	X											
Auxiliary Battery Kit	2877344		X	X	X	X	X	X	X	X			
Auxiliary Battery Kit	2876535										X	X	
Lock & Ride Light Bar	2876547-458		X	X	X	X	X	X	X	X	X	X	X
<b>PROTECTION</b>													
Front Brushguard Extension	2877765-458	X											
Front Brushguard	2877822-521		X	X	X	X	X	X	X	X	X	X	X
Extreme Front Brushguard	2876978-521		X	X	X	X	X	X	X	X	X	X	X
Pre-Runner Front Brushguard	2876980-521		X	X	X	X	X	X	X	X	X	X	X
Pre-Runner Rear Brushguard	2877339-521		X	X	X	X	X	X	X	X	X	X	X
Standard Rear Bumper	2877711-458	X											
Stock Rear Brushguard	2877340-521		X	X	X	X	X	X	X	X	X	X	X
Front Brushguard	2874961-418										X	X	X
Brushguard Extensions	2875059-418										X	X	X
Extreme Front Brushguard	2876171-418										X	X	X
Extreme Rear Brushguard	2876172-418										X	X	X
Rear Bumper 4x4 (Rear Brushguard)	2875050-418										X	X	X
Headlight Guards	2874962-418										X	X	X
Front A-Arm Guards	2877029		X	X	X	X	X	X	X	X			
Rear A-Arm Guards	2877030		X	X	X	X	X	X	X	X			
Extreme Front Side Guard	2876204-418</												

# FIT CHARTS



2010 FIT CHARTS

PRODUCT NAME	PART NO.	RANGER											
		MY 10 RANGER 400, EV	MY 10 RANGER 404, XP	MY 10 RANGER 400	MY 10 RANGER 406	MY 10 RANGER CREW	MY 09 RANGER 404, XP	MY 09 RANGER 400	MY 05-08 RANGER 204, 404	MY 05-08 RANGER 400	MY 05-08 RANGER 406	MY 08-09 RANGER CREW	
<b>COMFORT/STYLE</b>													
Extended Fender Flare Kit	2877027-067		X	X		X	X	X					
Flexsteel Premium Seat (Adjustable)	2876975-067		X	X	X	X	X	X					
RANGER Grab Handle	2858185	X	X	X	X	X	X	X	X	X	X	X	X
Universal Rear View Mirror	2876437	X	X	X	X	X	X	X	X	X	X	X	X
Performance Steering Rim	2876164		X	X	X	X	X	X	X	X	X	X	X
Steering Rim Adaptor Hub	2876619		X	X	X	X	X	X	X	X	X	X	X
Billet Shift Knob	2877074		X	X	X	X	X	X	X	X	X	X	X
Billet Hood Hinges	2877072		X	X	X	X	X	X	X	X	X	X	X
Flexsteel® Premium Seat Kit	2876817-070								X	X	X	X	X
<b>TRACKS</b>													
Prospector Pro Track System	2876664		X	X				X	X	X	X	X	X
Prospector Pro Track Mount Kit	2876904		X	X				X	X	X	X	X	X
Prospector Pro Track System Mount	2877053							X	X	X	X	X	X
<b>RIMS &amp; TIRES</b>													
36 cm Machined SIXr Rims with 66 cm Maxxis® Bighorn® Tires	2878032	X	X	X	X	X	X	X	X	X	X		X
36 cm Flat Black SIXr Rims with 66 cm Maxxis® Bighorn® Tires	2878030	X	X	X	X	X	X	X	X	X	X		X
Rear Load Boss Turf Tire	2875795	X	X	X	X	X	X	X	X	X	X	X	X
Front Load Boss Turf Tire	2875796	X	X	X	X	X	X	X	X	X	X	X	X
Turf Tire Rim	2871782		X	X				X	X	X	X	X	X
Spare Tire Holder	2875185		X	X				X	X	X	X	X	X
Spare Tire/Box Rack Mounting Bar (Spare Tire Bar)	2876191-418		X	X				X	X	X	X	X	X
38 cm Buckshot Rims with 66 cm Vision Trailfinder® Tires	2877604							X	X	X	X	X	X
36 cm Buckshot Rims with 66 cm Vision Trailfinder® Tires	2877605		X	X	X	X	X	X	X	X	X	X	X
36 cm Black Crusher Rims with 66 cm Maxxis® Bighorn® Tires	2877159	X	X	X	X	X	X	X	X	X	X	X	X
36 cm Bruiser Rims with 66 cm Maxxis® Bighorn® Tires	2876944	X	X	X	X	X	X	X	X	X	X	X	X
36 cm Silver Crusher Rims with 66 cm Maxxis® Bighorn® Tires	2876907	X	X	X	X	X	X	X	X	X	X	X	X
SAE® Lug Nuts for Aluminum rim (set of 4)	2876754	X	X	X	X	X	X	X	X	X	X	X	X
SAE® Lug Nuts for Aluminum rim (set of 16)	2877409	X	X	X	X	X	X	X	X	X	X	X	X

PRODUCT NAME	PART NO.	RANGER RZR				
		MY 08 RANGER RZR	MY 09 RANGER RZR	MY 10 RANGER RZR	MY 09 RANGER RZR S	MY 10 RANGER RZR S
<b>CABS</b>						
RANGER RZR Poly Cab	2877960	X	X	X		
RANGER RZR S Poly Cab	2877961				X	X
Steel Cab (Roof, Rear Panel, Windshield)	2877963	X	X	X	X	X
Steel Cab Doors	2877964	X	X	X	X	X
Steel Cab Wiper Kit	2877965	X	X	X	X	X
RANGERWARE® by Polaris Roof - Red	2878051-293	X	X	X	X	X
RANGERWARE® by Polaris Roof - Black	2878051-070	X	X	X	X	X
RANGERWARE® by Polaris Windshield - Red	2878057-293	X	X	X	X	X
RANGERWARE® by Polaris Windshield - Black	2878057-070	X	X	X	X	X
RANGERWARE® by Polaris Rear Panel - Red	2878056-293	X	X	X		
RANGERWARE® by Polaris Rear Panel - Black	2878056-070	X	X	X		
RANGERWARE® by Polaris Rear Panel - Black	2878067-070				X	X
Lock & Ride Cab	2877466	X		X		
RANGER RZR S Hard Cab	2877467				X	X
Canvas Cab	2877872	X	X	X	X	X
<b>CAB ACCESSORIES</b>						
Underdash Heater	2876451	X	X	X	X	X
Rear View Mirror	2876437	X	X	X	X	X
Underdash Blockoff Kit	2876900	X	X	X	X	X
Horn Kit	2877788	X	X	X	X	X
<b>ROOFS &amp; WINDSHIELDS</b>						
Sport Roof	2876456	X	X	X	X	X
Bimini Cab Top	2876434-070	X	X	X	X	X
Soft Top	2876703	X	X	X	X	X
Lock & Ride® Windshield	2876524	X	X	X	X	X
Half Windshield	2876435	X	X	X	X	X
Glass Windshield	2877420	X	X	X	X	X
Glass Windshield Wiper	2876854	X	X	X	X	X
Headache Net	2876441-070	X	X	X	X	X
Poly Rear Panel	2877327	X	X	X	X	X
Cloth Rear Panel	2877411	X	X	X	X	X
<b>PROTECTION</b>						
Front Aluminum Brushguard	2877308	X	X	X	X	X
Rear Aluminum Brushguard	2877309	X	X	X		
Pre-runner Front Brushguard	2876400-458	X	X	X	X	X
Pre-runner Rear Brushguard	2877468-458	X	X	X		
Deluxe Front Brushguard	2876520-458	X	X	X	X	X
Deluxe Rear Brushguard	2876521-458	X	X	X		
Front Extreme Fender Protectors	2876690-458	X	X	X		
Rear Extreme Fender Protectors	2876691-458	X	X	X		
Aluminum Rock Sliders	2877389	X	X	X	X	X
Rock Sliders	2876522-458	X	X	X	X	X
Nerf Bars	2876692-458	X	X	X	X	X
Fender Flare Kit	2877314	X	X	X		
Underbody Skid Plate	2876736	X	X	X	X	X
RANGER Front A-Arm Guards	2876734	X	X	X		
RANGER Rear A-Arm Guards	2876735	X	X	X		
RANGER RZR S Front A-Arm Guards	2877322				X	X
RANGER RZR S Rear A-Arm Guards	2877323				X	X
Rear Differential Skid Plate	2877026	X				
Rear Differential Skid Plate 09-10	2877728		X	X	X	X
<b>PLOWS</b>						
Glacier II RZR Plow Mount	2876450	X	X	X	X	X
Glacier II Plow Frame	2876623	X	X	X	X	X
132 cm Snow Blade	2876627	X	X	X		
152 cm Snow Blade	2876626	X	X	X	X	X
152 cm Razor Two-way Blade	2875370	X	X	X	X	X
<b>WINCHES</b>						
RZR 3.5 Polaris Sealed Winch	2877349	X	X	X	X	X
RZR Warn 3.0 Winch	2876446	X	X	X	X	X
Shift Knob Winch Controller	2877874	X	X	X	X	X
<b>STORAGE</b>						
Lock & Ride Box Cover	2877959	X	X	X	X	X
Lock & Ride Cargo Box	2876439-070	X	X	X	X	X
Lock & Ride Bed Extender	2877316-458	X	X	X		
Box Net	2876702	X	X	X	X	X

RANGER  
PG. 190 - 194

RANGER RZR  
PG. 195 - 197

ATV UTILITY  
PG. 198 - 200

ATV PERFORMANCE  
PG. 201



# FIT CHARTS

PRODUCT NAME	PART NO.	RANGER RZR				
		MY 08 RANGER RZR	MY 09 RANGER RZR	MY 10 RANGER RZR	MY 09 RANGER RZR S	MY 10 RANGER RZR S
<b>STORAGE (CONTINUED)</b>						
Lock & Ride Tie Down Bar	2876417-458	X	X	X	X	X
D-ring Kit	2877460	X	X	X	X	X
Lock & Ride Fuel Can Mount	2876379-458	X	X	X	X	X
Lock & Ride Flag Mount	2877502	X	X	X	X	X
Lock & Ride Accessory Rack	2876378-458	X	X	X		
Spare Tire Bar	2876402-458	X	X	X		
Spare Tire Holder	2877358	X	X	X		
RANGER RZR S Spare Tire Holder	2877319-458				X	X
Under Dash Passenger Bag	2876707	X	X	X	X	X
Gun Scabbard Mount	2876401-458	X	X	X		
RANGER RZR S Gun Scabbard	2877320-458				X	X
Black Gun Boot	2872677	X	X	X	X	X
Mossy Oak Break-Up® Gun Boot	2872677-419	X	X	X	X	X
Under Dash Passenger Bag	2876707	X	X	X	X	X
Overhead Map Bag	2877664	X	X	X	X	X
Shoulder Storage Bag	2877665	X	X	X	X	X
Passenger Glove Box	2877310	X	X	X	X	X
RANGER RZR Cover	2876526	X	X	X		
RANGER RZR S Cover	2877321				X	X
<b>PERFORMANCE</b>						
Long Travel Kit	2877312		X	X		
RANGER RZR S Fox Podium Shock Kit	2877313		w/ Long Travel Kit	w/ Long Travel Kit		
RANGER RZR S Walker Evans Front Shock*	2877835				X	X
RANGER RZR S Walker Evans Rear Shock*	2877789				X	X
RANGER RZR Walker Evans Front Shock*	2876898	X	X	X		
RANGER RZR Walker Evans Rear Shock*	2876899	X	X	X		
Front Shock Covers	2876848	X	X	X		
Rear Shock Covers	2876849	X	X	X		
RANGER RZR S Slip-on Exhaust	2877617				X	X
RANGER RZR Slip-on Exhaust	2876850	X	X	X		
RANGER RZR Performance Header	2877318	X	X	X		
<b>RIMS &amp; TIRES</b>						
36 cm Machined SIXr Rims with 66 cm Maxxis® Bighorn® Tires	2878032	X	X	X		
36 cm Flat Black SIXr Rims with 66 cm Maxxis® Bighorn® Tires	2878030	X	X	X		
36 cm Bruiser Rims with 66 cm Maxxis® Bighorn® Tires	2876944	X	X	X		
36 cm Silver Crusher Rims with 66 cm Maxxis® Bighorn® Tires	2876907	X	X	X		
36 cm Black Crusher Rims with 66 cm Maxxis® Bighorn® Tires	2877159	X	X	X		
36 cm Buckshot Rims with 66 cm Vision Trailfinder™ Tires	2877605	X	X	X		
30 cm Aluminum Front Rim	2876086	X	X	X		
30 cm Aluminum Rear Rim	2876087	X	X	X		
<b>TRACKS</b>						
Prospector Pro Track Mounts	2876449	X	X	X		
Prospector Pro-S Track Kit	2877539	X	X	X		
Prospector Pro Update Kit	2877540	X	X	X		
<b>LIGHTING</b>						
Auxiliary Battery Kit	2876696	X	X	X	X	X
Off-road Light Bar Kit	2877966	X	X	X	X	X
Lock & Ride Light Bar	2876547-458	X	X	X	X	X
PIAA® 35 Watt Light	2876684	X	X	X	X	X
Black Rally Light	2877335	X	X	X	X	X
Chrome Rally Light	2876445	X	X	X	X	X
Bumper Wire Harness	2877399	X	X	X	X	X
Light Bar Wire Harness	2877336	X	X	X	X	X
<b>GRAPHICS</b>						
Flame Decal Package	2876698	X	X	X	X	X
Paintable Plastic (TPO)	2203798	X	X	X	X	X
Tribal Blue/Silver Paint Kit	2877967	X	X	X	X	X
True Blue Flame Paint Kit	2877968	X	X	X	X	X
152 cm Razor Two-way Blade	2875370	X	X	X	X	X
<b>AUDIO</b>						
Jensen® CD/Radio Head Unit	2876173-02	X	X	X	X	X
Radio Mount Kit	2876897	X	X	X	X	X
Overhead Speaker Mount Console	2876443	X	X	X	X	X

PRODUCT NAME	PART NO.	RANGER RZR				
		MY 08 RANGER RZR	MY 09 RANGER RZR	MY 10 RANGER RZR	MY 09 RANGER RZR S	MY 10 RANGER RZR S
<b>AUDIO (CONTINUED)</b>						
Kick Panel Speaker Enclosure	2876924	X	X	X	X	X
Kicker® Speaker	2876179	X	X	X	X	X
AM/FM Antenna	2876183	X	X	X	X	X
iPod® Cable	2876764	X	X	X	X	X
<b>CUSTOM</b>						
Hood Scoop	2877876	X	X	X	X	X
Seat Cover	2877324	X	X	X	X	X
Custom Seat	2877306	X	X	X	X	X
Stock Seat Sliders	2877390	X	X	X	X	X
Performance Steering Rim	2876164	X	X	X	X	X
Billet Steering Rim Adaptor Hub	2876619	X	X	X	X	X
Black Steering Rim Adaptor Hub	2877419	X	X	X	X	X
Polished Billet Box Rails	2877307	X	X	X	X	X
Billet Box Rails	2877413	X	X	X	X	X
Billet Bumper End Caps	2877414	X	X	X	X	X
Billet Speedo Bezel	2877415	X	X	X	X	X
Billet Passenger Handle	2877416	X	X	X	X	X
Billet Shifter	2876714	X	X	X	X	X
Billet Gas Cap	2876923	X	X	X	X	X
Billet Fasteners (10 pk)	2877672	X	X	X	X	X
Stainless Steel Polaris Letters	2877325	X	X	X	X	X

RANGER  
PG. 190 - 194

RANGER RZR  
PG. 195 - 197

ATV UTILITY  
PG. 198 - 200

ATV PERFORMANCE  
PG. 201

# FIT CHARTS

PRODUCT NAME	PART NO.	ATV UTILITY										
		MY09-10 SPORTSMAN 550 / 650XP	MY05-10 SPORTSMAN 500/600/700/800	MY10 SPORTSMAN X2 550	MY07-09 SPORTSMAN X2 500 / 800	MY10 SPORTSMAN TOURING 550 / 650	MY08-10 SPORTSMAN TOURING 500 / 800	MY09-10 SPORTSMAN 606	MY06-10 SPORTSMAN 300 / 400 HAWKEYE	MY10 TRAIL BOSS	MY10 TRAIL BLAZER 6 SCRAMBLER	
<b>WINCHES</b>												
Sportsman XP Polaris 1587 kg Winch	2877820	MY10										
Sportsman XP Polaris 1587 kg Winch	2876591	MY09		X								
Sportsman Polaris 1587 kg Winch	2877303		X		X							
Sportsman XP Polaris 1133 kg Winch	2877819	MY10										
Sportsman XP Polaris 1133 kg Winch	2876592	MY09		X		X						
Sportsman Polaris 1133 kg Winch	2877302		X		X							
Sportsman XP Warn® RT 30 Winch	2877821	MY10										
Sportsman XP Warn® RT 30 Winch	2877455	MY09		X		X						
Sportsman Warn® RT 30 Winch	2876819		X		X							
Polaris 680 kg Winch	2875880							300/ Hawkeye				
Sportsman Polaris 680 kg Winch	2876639							400				
Polaris 680 kg Winch	2877976									X		
Winch Mount and Strap Kit	2854644				X							
Winch Mount and Strap Kit	2854619											
<b>PLOWS</b>												
Sportsman Glacier II Mount Plate	2876593	X				X			X			
Glacier II Mount Plate	2876625											
Glacier II Mount Plate	2877944				X		X		X	X		
Sportsman XP Glacier II Plow Frame	2876594	X				X		X				
Glacier II Plow Frame	2876623				X		X		X	X		
Glacier I Mount Plate	2876842				MY 05-09 Twin					X		
Glacier I Mount Plate	2876841				MY 05-07 Single		Use with 2876020		Use with 2876020			
Glacier I Plow Frame	2876840				X		X		X	X		
Sportsman X2 Mount Adaptor	2876020						X					
Sportsman XP Easy Lift Plow Mount	2877261	X					X		X			
Sportsman Easy Lift Plow Mount	2877380						X		X			
Sportsman Easy Lift Plow Mount	2877260				Twin							
Sportsman Easy Lift Plow Mount	2877259				Single							
Easy Lift Plow Frame	2877262	X			X	X	X	X	X	X	X	
Frame Extension for Easy Lift Plow	2878021	X			X	X	X	X	X	X	X	
152 cm Snow Blade	2876626	X			X	X	X	X	X	X	X	
132 cm Snow Blade	2876627	X			X	X	X	X	X	X	X	
122 cm Snow/Dirt Blade	2876814	X			X	X	X	X	X	X	X	
152 cm Razor Two-way Blade	2875370	X			X	X	X	X	X	X	X	
122 cm One-way Blade w/ Deflectors	2872684	X			X	X	X	X	X	X	X	
226 kg Plow Lift	2875881				X		X		X	X		
<b>TRACKS</b>												
Prospector Pro-S Track Kit [set of 4 tracks]	2877539	X			X							
Sportsman XP Prospector Pro® Track Mount Kit	2876617	X										
Sportsman Prospector Pro Track Mount Kit	2876002				X	X	X	X	X			
Prospector Pro Track Mount Kit	2876659				X			X				
Sportsman X2 Prospector Pro Track Mount Kit	2875884											
<b>RIMS &amp; TIRES</b>												
36 cm Sportsman XP Rims with 66 cm Vision Trailfinder™ Tires	2877386	X					MY 06-09		X			
38 cm Buckshot Rims with 66 cm Vision Trailfinder™ Tires	2877604				X	X			X			
36 cm Buckshot Rims with 66 cm Vision Trailfinder™ Tires	2877605				X				X	X		
36 cm Black Crusher Rims with 66 cm Maxxis® Bighorn® Tires	2877159		X		X				X	X		
36 cm Bruiser Rims with 66 cm Maxxis® Bighorn® Tires	2876944		X		X				X	X		
36 cm Silver Crusher Rims with 66 cm Maxxis® Bighorn® Tires	2876907		X		X				X	X		
36 cm x 18 cm Front SIXr Machined Rim	1521507-266		X		X				X	X		
36 cm x 20 cm Rear SIXr Machined Rim	1521508-266		X		X				X	X		
36 cm x 18 cm Front SIXr Flat Black Rim	1521507-521		X		X				X	X		
36 cm x 20 cm Rear SIXr Flat Black Rim	1521508-521		X		X				X	X		
36 cm x 18 cm Front Sportsman XP Rim	1521402	X		X		X						
36 cm x 20 cm Rear Sportsman XP Rim	1521403	X		X		X						
36 cm x 18 cm Front Crusher Rim	2877157		X		X				X	X		
36 cm x 20 cm Rear Crusher Rim - Black	2877158		X		X				X	X		
36 cm x 18 cm Front Crusher Rim	2876281		X		X				X	X		
36 cm x 20 cm Rear Crusher Rim	2876282		X		X				X	X		
36 cm x 18 cm Front Bruiser Rim	2875904		X		X				X	X		
36 cm x 20 cm Rear Bruiser Rim	2875905		X		X				X	X		

PRODUCT NAME	PART NO.	ATV UTILITY										
		MY09-10 SPORTSMAN 550 / 650XP	MY05-10 SPORTSMAN 500/600/700/800	MY10 SPORTSMAN X2 550	MY07-09 SPORTSMAN X2 500 / 800	MY10 SPORTSMAN TOURING 550 / 650	MY08-10 SPORTSMAN TOURING 500 / 800	MY09-10 SPORTSMAN 606	MY06-10 SPORTSMAN 300 / 400 HAWKEYE	MY10 TRAIL BOSS	MY10 TRAIL BLAZER 6 SCRAMBLER	
<b>RIMS &amp; TIRES</b>												
30.5 x 20 cm Rear Bruiser Rim	2875903		X			X			X	X	X	
38 x 18 cm Front Buckshot Rim	1521431		X			X			X	X		
38 x 20 cm Rear Buckshot Rim	1521432		X			X			X	X		
36 x 18 cm Front Buckshot Rim	1521433		X			X			X	X		
36 x 20 cm Rear Buckshot Rim	1521434		X			X			X	X		
30.5 cm x 15 cm Cast Aluminum Rim	2876086		X			X			X	X		
30.5 cm x 18 cm Cast Aluminum Rim	2876087		X			X			X	X		
66x23x36 cm Maxxis® Bighorn® Front Tire	2876905	36cm wheel	36cm wheel	36cm wheel	36cm wheel	36cm wheel	36cm wheel	36cm wheel	36cm wheel	36cm wheel	36cm wheel	
66x28x36 cm Maxxis® Bighorn® Front Tire	2876906	36cm wheel	36cm wheel	36cm wheel	36cm wheel	36cm wheel	36cm wheel	36cm wheel	36cm wheel	36cm wheel	36cm wheel	
66x25.5x38 cm Vision Trailfinder® Front Tire	5413726											
66x30.5x38 cm Vision Trailfinder® Front Tire	5413727											
66x25.5x36 cm Vision Trailfinder® Front Tire	5413659	36cm wheel	36cm wheel	36cm wheel	36cm wheel	36cm wheel	36cm wheel	36cm wheel	36cm wheel	36cm wheel	36cm wheel	
66x30.5x36 cm Vision Trailfinder® Front Tire	5413660	36cm wheel	36cm wheel	36cm wheel	36cm wheel	36cm wheel	36cm wheel	36cm wheel	36cm wheel	36cm wheel	36cm wheel	
66x23x36 cm Goodyear® MTR Front Tire	2875906	36cm wheel	36cm wheel	36cm wheel	36cm wheel	36cm wheel	36cm wheel	36cm wheel	36cm wheel	36cm wheel	36cm wheel	
66x25x36 cm Goodyear® MTR Rear Tire	2875907	36cm wheel	36cm wheel	36cm wheel	36cm wheel	36cm wheel	36cm wheel	36cm wheel	36cm wheel	36cm wheel	36cm wheel	
66x23x36 cm Goodyear® MTR Front Tire	2875906	36cm wheel	36cm wheel	36cm wheel	36cm wheel	36cm wheel	36cm wheel	36cm wheel	36cm wheel	36cm wheel	36cm wheel	
66x25x36 cm Goodyear® MTR Rear Tire	2875907	36cm wheel	36cm wheel	36cm wheel	36cm wheel	36cm wheel	36cm wheel	36cm wheel	36cm wheel	36cm wheel	36cm wheel	
30.5 cm Beadlock Rims with Kenda® Bear Claw™ Tire	2875606		X			X			X	X	X	
63.5x21.5x30.5 cm Kenda® Bear Claw™ Front Tire	5412516		30.5cm wheel			30.5cm wheel			30.5cm wheel	30.5cm wheel	30.5cm wheel	
63.5x25.5x30.5 cm Kenda® Bear Claw™ Rear Tire	5412517		30.5cm wheel			30.5cm wheel			30.5cm wheel	30.5cm wheel	30.5cm wheel	
63.5x21.5x30.5 cm Kenda® Executioner® Front Tire	2875235		30.5cm wheel			30.5cm wheel			30.5cm wheel	30.5cm wheel	30.5cm wheel	
63.5x25.5x30.5 cm Kenda® Executioner® Rear Tire	2875234		30.5cm wheel			30.5cm wheel			30.5cm wheel	30.5cm wheel	30.5cm wheel	
63.5x21.5x30.5 cm Load Boss Front Turf Tire	2875796		30.5cm wheel			30.5cm wheel			30.5cm wheel	30.5cm wheel	30.5cm wheel	
63.5x25.5x30.5 cm Load Boss Rear Turf Tire	2875795		30.5cm wheel			30.5cm wheel			30.5cm wheel	30.5cm wheel	30.5cm wheel	
58.5x18x30.5 cm Carlisle® ACT Front Tire	2876084		30.5cm wheel			30.5cm wheel			30.5cm wheel	30.5cm wheel	30.5cm wheel	
58.5x25.5x30.5 cm Carlisle® ACT Rear Tire	2876085		30.5cm wheel			30.5cm wheel			30.5cm wheel	30.5cm wheel	30.5cm wheel	
SAE® Lug Nuts for Aluminum rim [set of 4]	2876754		X			X			X	X	X	
SAE® Lug Nuts for Aluminum rim [set of 16]	2877409		X			X			X	X	X	
Metric Lug Nuts for Aluminum rim [set of 4]	2877385	X				X			X			
Metric Lug Nuts for Aluminum rim [set of 16]	2877384	X				X			X			
<b>WINDSHIELDS</b>												
XP Tall Lock & Ride Windshield	2876606	X				X			X			
XP Mid Lock & Ride Windshield	2876609	X				X			X			
XP Low Lock & Ride Windshield - Black	2876608	X				X			X			
XP Low Lock & Ride Windshield - Chrome	2876610	X				X			X			
Sportsman Tall Lock & Ride Windshield	2876017		X			X			X	X		
Sportsman Mid Lock & Ride Windshield	2876018		X			X			X	X		
Sportsman Low Lock & Ride Windshield - Black	2875781		X			X			X	X		
Sportsman Low Lock & Ride Windshield - Chrome	2875805		X			X			X	X		
Sportsman 300/400 Lock & Ride Windshield	2875682									X	X	X
<b>PROTECTION</b>												
Sportsman XP Deluxe Front Brushguard	2876595	X				X			X			
Sportsman XP Deluxe Rear Brushguard	2876597	X				X			X			
Sportsman XP Extreme Front Brushguard	2876596	X				X			X			
Sportsman XP Extreme Rear Brushguard	2876607	X				X			X			
Deluxe Front Brushguard	2876102-418		X			X			X	X		
Deluxe Front Brushguard	2876637-418		X			X			X	X		
Front Dual Tube Brushguard	2878043		X			X			X	X		
Rear Brushguard	2878046		X			X			X	X		
Rear Brushguard	2876098-418									X		
Rear Brushguard	2877918								X			
Sportsman X2 Rear Bumper	2877686					X			X			
Hand Guards	2874871-177									X	X	X
Hand Guards	2875709-177	X				X			X	X	X	
Aluminum Front A-Arm Guards	2877681	X				X			X			
Aluminum Rear A-Arm Guards	2877682	X				X			X			



# FIT CHARTS

## ATV UTILITY

PRODUCT NAME	PART NO.	ATV UTILITY										
		MY09-10 SPORTSMAN 550 / 650XP	MY05-10 SPORTSMAN 500/600/700/800	MY10 SPORTSMAN X2 550	MY07-09 SPORTSMAN X2 500 / 600	MY10 SPORTSMAN TOURING 550 / 650	MY08-10 SPORTSMAN TOURING 500 / 600	MY09-10 SPORTSMAN 600	MY09-10 SPORTSMAN 500 / 400 HAWKEYE	MY10 TRAIL BOSS	MY10 TRAIL BLAZER & SCRAMBLER	
<b>STORAGE</b>												
Sportsman XP Lock & Ride Backrest	2876616	X										
Sportsman Lock & Ride Backrest	2876368		X									
Lock & Ride Backrest	2875705								X			
Sportsman XP Front Cargo Bag	2876602	X										
Sportsman XP Rear Cargo Bag	2876603	X										
Sportsman XP Fender Bag	2876604	X		X		X						
Sportsman XP Front Pouch Bag	2876615	X										
Sportsman XP Headlight Pod Bag	2876605	X		X		X						
Backrest Backpack	2876856					X	X					
Semi-Rigid Touring Cargo Bag	2877220							X				
Sportsman Rear Cargo Bag	2875307-070		X									
Sportsman Rear Cargo Bag	2875307-419		X									
Front Cargo Bag	2875651							X	X			
Rear Cargo Bag	2875677							X				
Sportsman Fender Bag	2875306-070		X		X		X	X				
Sportsman Fender Bag	2875306-419		X		X		X	X				
Fender Bag	2876024							X				
Sportsman Tank Bag	2875318-070		X		X		X	X				
Sportsman Tank Bag	2876594	X			X		X					
Sportsman X2 Dual Cargo Bags	2876623				X		X	X	X			
Sportsman X2 Rear Cargo Bag	2876842				MY 05-09 Twin					X		
Lock & Ride Chainsaw/Work Box	2876841				MY 05-07 Single		Use with 2876020	Use with 2876020				
Sportsman 5 Gallon Bucket Holder	2876840				X		X	X	X			
Rear Cargo Rack Basket - 15 cm Tall	2876020						X					
Lock and Ride Steel Basket Mount	2877261	X				X		X				
Sportsman Lock & Ride Steel Compartment Rack	2877380						X		X			
Rear Rack	2877260				Twin							
Sportsman XP Composite Front Rack Extender	2876598	X										
Sportsman XP Composite Rear Rack Extender	2876599	X										
Sportsman XP Steel Front Rack Extender	2877573	X										
Sportsman XP Steel Rear Rack Extender	2877574	X										
Sportsman Front Rack Extender	2878044		X		X		X	X				
Sportsman Rear Rack Extender	2878045		X									
Rear Rack Extender	2876486-418						X					
Front Rack Extender	2876094-418							X				
Rear Rack Extender	2876095-418							X				
Front Rack Extender	2877746								X			
Rear Rack Extender	2877745								X	X		
Sportsman XP Gun Scabbard Mount, Right or Left Side	2877381	X										
Sportsman Gun Scabbard Mount, Right Side	2876276		X									
Sportsman Gun Scabbard Mount, Left Side	2876275		X									
Sportsman Touring Gun Scabbard Mount	2876493						X					
Sportsman Touring Gun Scabbard Mount	2876000						X					
Sportsman X2 Gun Scabbard Mount, Right or Left Side	2875783			X	X							
Gun Scabbard Mount, Right Side	2876416							X				
Gun Scabbard Mount, Left Side	2875704							X				
Kolpin Gun Scabbard - Black	2872677							Requires Mount				
Kolpin Gun Scabbard - Mossy Oak	2872677-419							Requires Mount				
<b>CUSTOM</b>												
Handlebar Mounted Mirror	2877222	X	X	X	X	X	X	X	X	X	X	X
8 cm Passenger Foot Risers	2877919			X		X						
18 cm Passenger Foot Risers	2876885				X		X					
8 cm Passenger Foot Risers	2875782				X		X					
Hand Warmers	2877363	X	X	X	X	X	X	X	X	X	X	X
Throttle/Thumb warmer	2877364	X	X	X	X	X	X	X	X	X	X	X
<b>TRAILERING</b>												
Sportsman Trailerable ATV Cover	2876614	X	X									
Sportsman Touring Trailerable ATV Cover	2877999					X	X					
Sportsman X2 Trailerable ATV Cover	2877998			X	X							
Trailerable ATV Cover	2875718							X				
2.5 cm Drop Receiver Hitch Draw Bar	2877476	X			X							
8 cm Drop Receiver Hitch Draw Bar	2873365	X			X							
5 cm Ball	2877602	X			X	X	X	X	X	X		
8 cm Ball	2877603	X			X	X	X	X	X	X		

## ATV PERFORMANCE

PRODUCT NAME	PART NO.	ATV PERFORMANCE			
		MY 03-05 OUTLAW 500	MY06-07 OUTLAW 500 IRS	MY 07-10 PREDATOR 525 IRS	MY 08-09 PREDATOR 450 MXR / 525 S
<b>NERF BARS / HEEL POCKETS</b>					
Nerf Bars	2876843	X	X	X	X
Outlaw Heel Pockets	2877598			MY 09-10	
Foot Peg Extensions	2875433	X	X	X	X
<b>BUMPERS/GUARDS/GRAB BARS</b>					
Aluminum A-Arm Guards	2877601		X	X	X
Aluminum Skid Plate	2877600		X	X	X
Outlaw Front Grab Bar	2876356		X	X	X
Outlaw Rear Grab Bar	2876157		X	X	X
High Profile Hand Guard	2875974-177	X	X	X	X
High Profile Hand Guard	2875974-053	X	X	X	X
High Profile Hand Guard	2875974-288	X	X	X	X
Low Profile Hand Guard	2875973-177	X	X	X	X
Low Profile Hand Guard	2875973-053	X	X	X	X
Low Profile Hand Guard	2875973-288	X	X	X	X
Hand Guard Mount Bracket	2875972	X	X	X	X
Hand Guards	2875655	X	X	X	X
<b>EXHAUST/PERFORMANCE</b>					
Outlaw 525 IRS FMF Performance Silencer	2876741			X	
Outlaw 525 S/450 MXR FMF Performance Silencer	2876867				X
Outlaw 500 Performance E2 Silencer	2875940		X		
<b>COMFORT/STYLE/UTILITY</b>					
Outlaw Rear Rim Kit	2876078				
Trail Tech X-Bar	2875329			with Fat Bar Mount	
Trail Tech Billet Bar Clamp	2875330	X	X	X	X
Outlaw Gripper Seat	2876863		X	MY 07-08	MY 08
<b>SHOCKS</b>					
Outlaw Shock Covers	2875968		X	X	X
Polaris Front Shock Covers	2875970	X	X	X	X
Polaris Rear Shock Cover	2875971	X	X	X	X
Predator Front Shock Covers	2875966	X			
Predator Rear Shock Cover	2875967	X			
<b>RACKS</b>					
Outlaw Rear Cargo Rack	2876156		X	MY 07-08	MY 08
Predator Rear Cargo Rack	2875284	X			
<b>FILTERS</b>					
K&N® Air Filters	2876739			X	
<b>COVERS</b>					
Trailerable Cover	2875935		X		

RANGER  
PG. 190 - 194

RANGER RZR  
PG. 195 - 197

ATV UTILITY  
PG. 198 - 200

ATV PERFORMANCE  
PG. 201

2010 FIT CHARTS



All riders pictured are professionals on a closed course. Polaris recommends that all riders take a training course. Do not attempt maneuvers beyond your capability. Always wear a helmet and other safety apparel. Never drink and ride. Polaris all-terrain vehicles depicted in this brochure feature Pure Polaris® parts and accessories and are not standard features of the base model vehicle they accompany. All performance and/or feature and benefit claims are based upon competitive data available at time of printing. For your nearest dealer, call 1-800-POLARIS or go to [purepolaris.com](http://purepolaris.com).

Polaris Sales Inc., 2100 Hwy. 55, Medina, MN 55340 (763) 542-0500 Fax (763) 542-0599

Polaris Industries LTD, 50 Prairie Way, Winnipeg, Manitoba Canada R2J 3J8 (204) 925-7100 Fax (204) 925-7110



Visit [www.polarisindustries.com](http://www.polarisindustries.com) for more information.